



National Products Inc.

2023 | **SAMSUNG** MOUNTING SOLUTIONS



Field Service . Healthcare . Manufacturing . Public Safety . Retail . Transportation . Warehouse



SAMSUNG

THE CONNECTED ASSOCIATE

There are many interpretations of what “The Connected Associate” looks like. Here at RAM® Mounts, we believe that The Connected Associate brings together the power of mobile devices, software, and accessories to enable an efficient workforce, all-in-one ecosystem of products. Our extensive ecosystem of enterprise-ready products has been carefully designed to support associates during every step of the freight management process, including transportation and logistics, material handling, inventory tracking, item picking, and more. For decades, RAM® Mounts has helped thousands of companies keep their devices protected and charged, adopt safety standards, and ruggedize their mobility.



2

3



4



1

SEEN IN THESE PHOTOS:

1. RAM-GDS-SKIN-SAM78-NG

IntelliSkin® Next Gen for Samsung Tab S8+ and More

RAM-GDS-ROTO2U

GDS® Roto-Mag™ 3-in-1 Accessory

2. RAM-GDS-DOCK-6G1P-NGU

GDS® 6-Port Desktop Charger for IntelliSkin® Next Gen

3. RAM-HOL-SAM52PD2U

RAM® Power & Dual USB Data Dock for Tab Active4 Pro & Tab Active Pro

RAM-KB4-USB

GDS® Keyboard™ with 10-Key Numeric Pad

4. RAM-GDS-SKIN-SAM76-NG

IntelliSkin® Next Gen for Samsung Tab S7 11"

RAM-GDS-DOCK-SAM76CU

GDS® Tough-Dock™ + Data Sync for Samsung Tab S7 11"

2



6



7



5

SEEN IN THESE PHOTOS:

- 5. RAM-DOCK-6G-SAM84CPU**
RAM® 6-Port Charging Dock for Samsung XCover6 Pro With RAM® Skin™
- 6. RAM-GDS-101LB2-SAM80CP-V7B1U**
GDS® Tough-Dock™ Locking Vehicle Bundle for Samsung Tab A7 Lite 8.7"
- 7. RAM-B-101-225B2-SAM60P-V7B1U**
RAM® EZ-Roll'r™ Powered Mount for Samsung Tab Active3 & 2

THE ECOSYSTEM

Connecting and protecting devices comes down to two things: ruggedized mounting and charging. RAM® Mounts designs and manufactures reliable docks and mounts that shield devices from damage, keep devices charged, and futureproofs the entire solution by creating an ecosystem of products that work together.

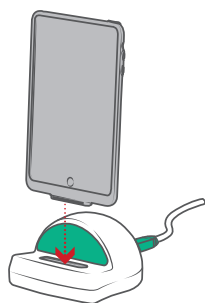

GDS® docking stations allow you to leverage Samsung DeX, transferring device functions to a desktop experience



Transfer the same devices to compatible RAM® docking stations for a wide variety of vehicles

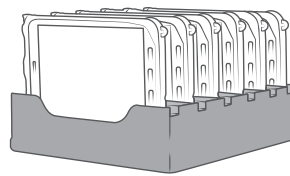

Multi-port docking stations keep devices charged overnight, reducing clutter and damage to charging ports

SEEN IN THIS PHOTO:

RAM-TC-SAM29U

RAM® Tough-Case™ with USB Type-A for Samsung Tab Active3 & 2

RAM-GDS-CHARGE-USB2QCIG

GDS® 2-Port USB Cigarette Charger with Qualcomm® Quick Charge™



TOP SOLUTIONS



pg.24 **RAM® SKIN™**



pg.6 **FORM-FIT DOCKS**



pg.24 **INTELLISKIN®**



pg.30 **GDS® TOUGH-DOCK™**



pg.34 **RAM® NFC REACH™**



pg.36 **TEMPERATURE CONTROL PRODUCTS**



pg.28 **ERGONOMIC ACCESSORIES**



pg.46 **SAMSUNG DEX**

SUPPORTED DEVICES

A20

- 26 INTELLISKIN®
- 32 GDS® TOUGH-DOCK™
- 42 RAM® TAB-TITE™ & TAB-LOCK™
- 44 RAM® X-GRIP®

S20

- 26 INTELLISKIN®
- 32 GDS® TOUGH-DOCK™
- 42 RAM® TAB-TITE™ & TAB-LOCK™
- 44 RAM® X-GRIP®

XCOVER PRO

- 16 SAMSUNG XCOVER PRO & FIELDPRO
- 20 DESKTOP DOCKS
- 22 GDS® DESKTOP DOCKS™ FOR INTELLISKIN®
- 24 RAM® SKIN™
- 26 INTELLISKIN®
- 32 GDS® TOUGH-DOCK™
- 42 RAM® TAB-TITE™ & TAB-LOCK™
- 44 RAM® X-GRIP®

XCOVER6 PRO

- 14 SAMSUNG XCOVER6 PRO & XCOVER 5
- 20 DESKTOP DOCKS
- 26 INTELLISKIN®

XCOVER FIELDPRO

- 16 SAMSUNG XCOVER PRO & FIELDPRO
- 20 DESKTOP DOCKS
- 26 INTELLISKIN®
- 32 GDS® TOUGH-DOCK™
- 42 RAM® TAB-TITE™ & TAB-LOCK™
- 44 RAM® X-GRIP®

TAB ACTIVE3 & 2

- 6 FORM-FIT DOCKS
- 8 MODULAR DOCKS
- 9 LOW-PROFILE DOCKS
- 10 OTTERBOX UNIVERSE DOCKS
- 12 PERIPHERAL ENABLEMENT
- 18 DESKTOP DOCKS FOR TABLETS
- 24 RAM® SKIN™
- 26 INTELLISKIN®
- 32 GDS® TOUGH-DOCK™
- 38 RAM® TOUGH-CASE™
- 42 RAM® TAB-TITE™ & TAB-LOCK™
- 44 RAM® X-GRIP®
- 48 POPULAR RAM® MOUNTS
- 50 TRANSPORTATION BUNDLES

TAB ACTIVE4 PRO & TAB ACTIVE PRO

- 6 FORM-FIT DOCKS
- 12 PERIPHERAL ENABLEMENT
- 18 DESKTOP DOCKS FOR TABLETS
- 24 RAM® SKIN™
- 26 INTELLISKIN®
- 32 GDS® TOUGH-DOCK™
- 38 RAM® TOUGH-CASE™
- 42 RAM® TAB-TITE™ & TAB-LOCK™
- 44 RAM® X-GRIP®
- 50 TRANSPORTATION BUNDLES

TAB A 8.0" (2019)

- 26 INTELLISKIN®
- 30 GDS® VEHICLE DOCKS
- 32 GDS® TOUGH-DOCK™
- 38 RAM® TOUGH-CASE™
- 42 RAM® TAB-TITE™ & TAB-LOCK™
- 44 RAM® X-GRIP®

TAB A 8.4"

- 26 INTELLISKIN®
- 30 GDS® VEHICLE DOCKS
- 32 GDS® TOUGH-DOCK™
- 38 RAM® TOUGH-CASE™
- 42 RAM® TAB-TITE™ & TAB-LOCK™
- 44 RAM® X-GRIP®

TAB A 10.1" (2019)

- 26 INTELLISKIN®
- 32 GDS® TOUGH-DOCK™
- 38 RAM® TOUGH-CASE™
- 42 RAM® TAB-TITE™ & TAB-LOCK™
- 44 RAM® X-GRIP®

TAB A7 LITE 8.7"

- 26 INTELLISKIN®
- 30 GDS® VEHICLE DOCKS
- 42 RAM® TAB-TITE™ & TAB-LOCK™
- 44 RAM® X-GRIP®
- 50 TRANSPORTATION BUNDLES

TAB A7 10.4"

- 26 INTELLISKIN®
- 32 GDS® TOUGH-DOCK™
- 38 RAM® TOUGH-CASE™
- 42 RAM® TAB-TITE™ & TAB-LOCK™
- 44 RAM® X-GRIP®

TAB A8 10.5"

- 26 INTELLISKIN®
- 30 GDS® VEHICLE DOCKS
- 42 RAM® TAB-TITE™ & TAB-LOCK™
- 44 RAM® X-GRIP®

TAB S7 11"

- 26 INTELLISKIN®
- 30 GDS® VEHICLE DOCKS
- 44 RAM® X-GRIP®

TAB S7+ & S7 FE 12.4"

- 26 INTELLISKIN®
- 30 GDS® VEHICLE DOCKS
- 44 RAM® X-GRIP®

ACCESSORIES

- 28 RAM® SKIN™ & INTELLISKIN® ACCESSORIES
- 34 RAM® NFC REACH™
- 36 TEMPERATURE CONTROL PRODUCTS
- 46 SAMSUNG DEX IN-VEHICLE

Supports factory OEM skin and RAM® Skin™

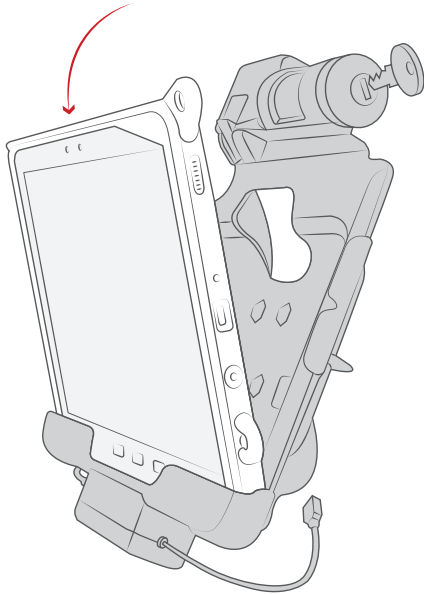

FORM-FIT DOCKS

For a slim, clean mounting solution, form-fit holders offer a custom housing that perfectly fits select Samsung devices in their original OEM skin or the RAM® Skin™. Numerous add-ons and options include combination locks, key locks, dual USB, and power-only docks.



RAM-HOL-SAM60PD2U
RAM® EZ Roll'r™ Dual USB Dock for Samsung Tab Active3 & 2



RAM-HOL-SAM57PKLU
RAM® Key-Locking Powered Dock for Tab Active4 Pro & Tab Active Pro



RAM-HOL-SAM60PU
RAM® EZ-Roll'r™ Powered Dock for Samsung Tab Active3 & 2



RAM-HOL-SAM58PD2CLU
RAM® Combo Locking Power + Dual USB Dock for Samsung Tab Active3 & 2

AVAILABLE IN:



KEY LOCK



COMBO LOCK



NON-LOCKING



POWER



POWER + DATA

FEATURES

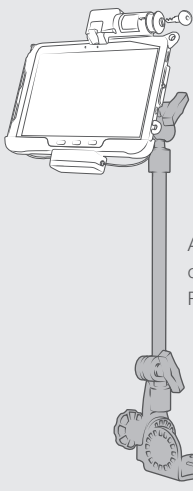

AMPS hole pattern connects to any RAM® vehicle mounts

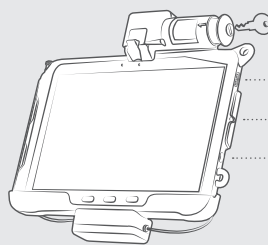

Speakers, mics, and headphone jack remain exposed

- 1 Speakers
- 2 Mics
- 3 Headphone Jack

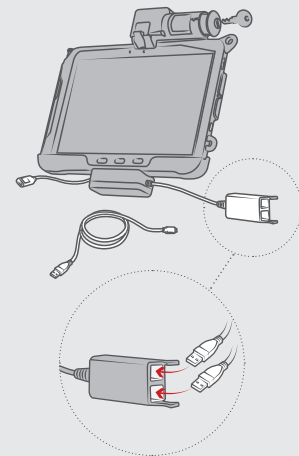

Keeps your tablet charged, protected, and connected to your peripherals



SEEN IN THIS PHOTO:

RAM-HOL-SAM57PD2KLU

RAM® Key-Locking Power + Dual USB Data Dock for Tab Active4 Pro

FORM-FIT DOCKS CONTINUED

TAB ACTIVE3 & 2					
PART NUMBER	⚡ POWER	🔒 KEY LOCKING	🔒 COMBO LOCKING	⚡ SINGLE USB PERIPHERAL	⚡ DUAL USB PERIPHERAL
RAM-HOL-SAM60PU	•				
RAM-HOL-SAM60PDU	•			•	
RAM-HOL-SAM60PD2U	•				•
RAM-HOL-SAM58PKLU	•	•			
RAM-HOL-SAM58PKLU	•	•		•	
RAM-HOL-SAM58PD2KLU	•	•			•
RAM-HOL-SAM58PCLU	•		•		
RAM-HOL-SAM58PDCLU	•		•	•	
RAM-HOL-SAM58PD2CLU	•		•		•

TAB ACTIVE PRO					
PART NUMBER	⚡ POWER	🔒 KEY LOCKING	🔒 COMBO LOCKING	⚡ SINGLE USB PERIPHERAL	⚡ DUAL USB PERIPHERAL
RAM-HOL-SAM52PU	•				
RAM-HOL-SAM52PDU	•			•	
RAM-HOL-SAM52PD2U	•				•
RAM-HOL-SAM57PKLU	•	•			
RAM-HOL-SAM57PCLU	•		•		
RAM-HOL-SAM57PDCLU	•		•	•	
RAM-HOL-SAM57PD2CLU	•		•		•
RAM-HOL-SAM57PKLU	•	•		•	
RAM-HOL-SAM57PD2KLU	•	•			•

FORM-FIT DOCKS CONTINUED

MODULAR DOCKS

The RAM® Modular Powered Dock series for Samsung Tab Active3 are thoughtfully designed to meet the demands of commercial truck drivers, field service technicians, pupil transporters, logistics managers, forklift operators, and more. Power capabilities through the dock are provided to the device through pogo pin technology, taking advantage of the Tab Active3's pogo pad docking contacts—simply dock the device for a seamless charging experience.

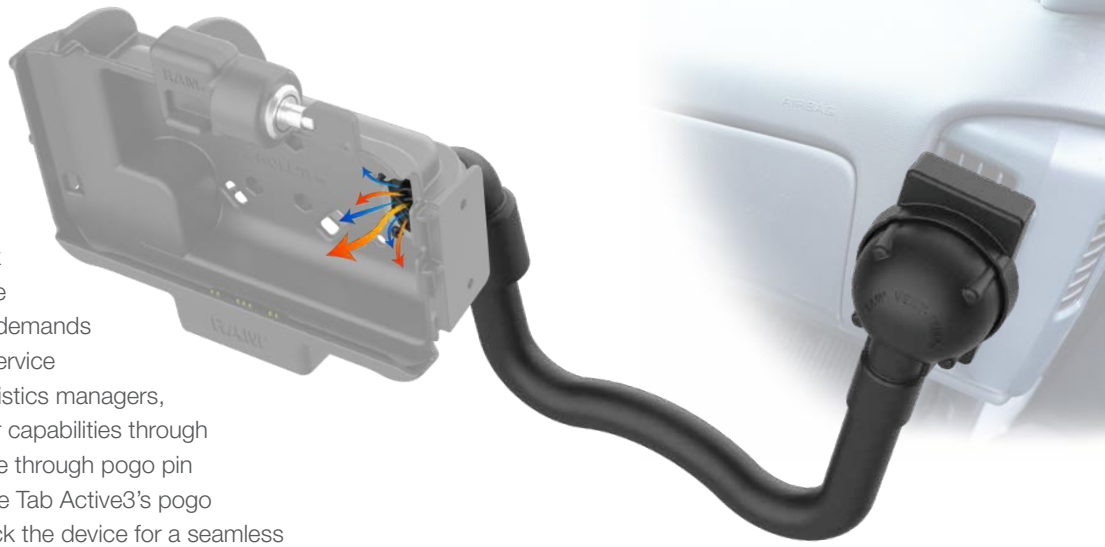

Supports RAM® Vent-Temp™ and Temp-Right™ Connections

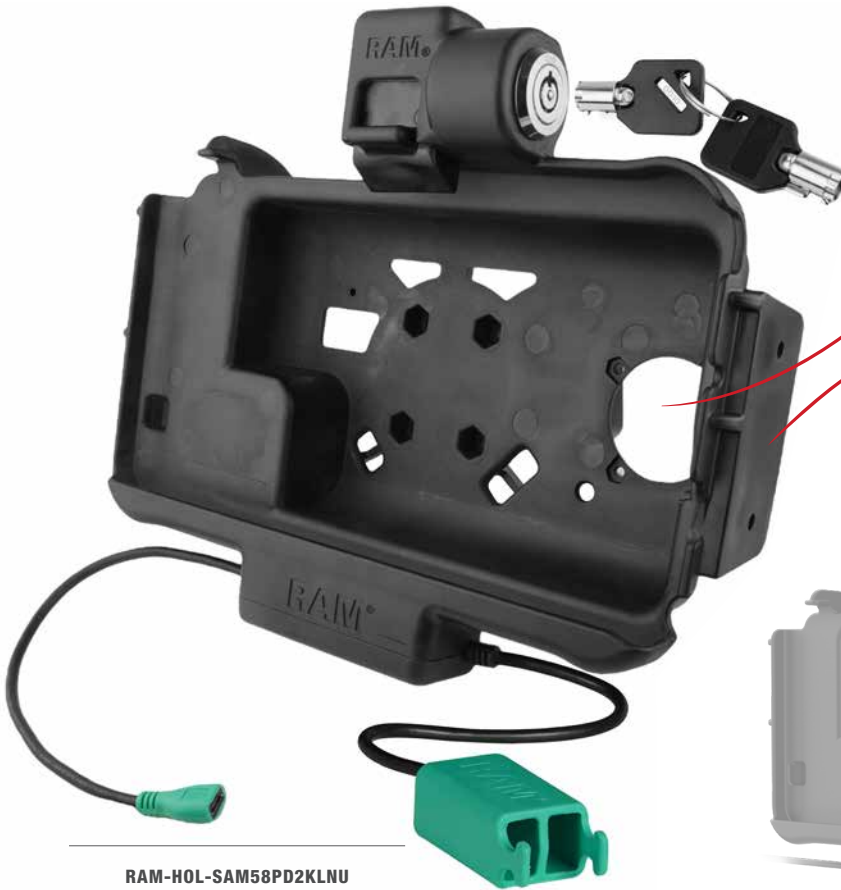

RAM-HOL-SAM58PD2KLNU

RAM® Locking Modular Power + Dual USB Dock for Tab Active3

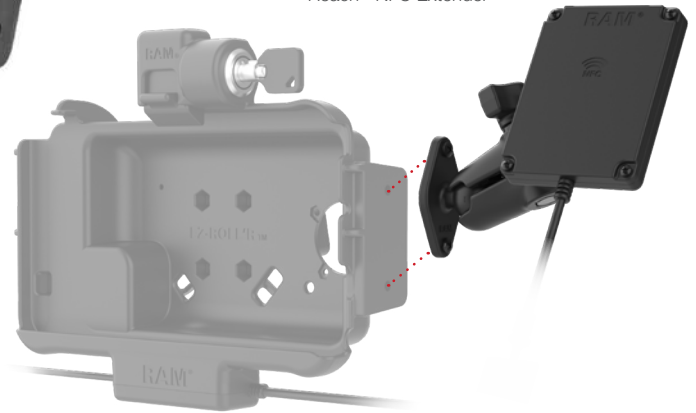

Supports RAM® NFC Reach™ NFC Extender

TAB ACTIVE3					
PART NUMBER	⚡ POWER	🔑 KEY LOCKING	🔒 NON-LOCKING	⚡ SINGLE USB PERIPHERAL	⚡🔌 DUAL USB PERIPHERAL
RAM-HOL-SAM58PKLNU	•	•			
RAM-HOL-SAM58PDKLNU	•	•		•	
RAM-HOL-SAM58PD2KLNU	•	•			•
RAM-HOL-SAM60PNU	•		•		
RAM-HOL-SAM60PDNU	•		•	•	
RAM-HOL-SAM60PD2NU	•		•		•

FORM-FIT DOCKS CONTINUED

LOW-PROFILE DOCKS

Our low-profile docks for Samsung Tab Active3 offer a slim profile at 2.28" in depth with a metal reinforcement plate for a smaller footprint. Power capabilities from the dock are provided to the device through pogo pin technology and integrated mUSB cable, taking advantage of the Tab Active3's pogo pad docking contacts.

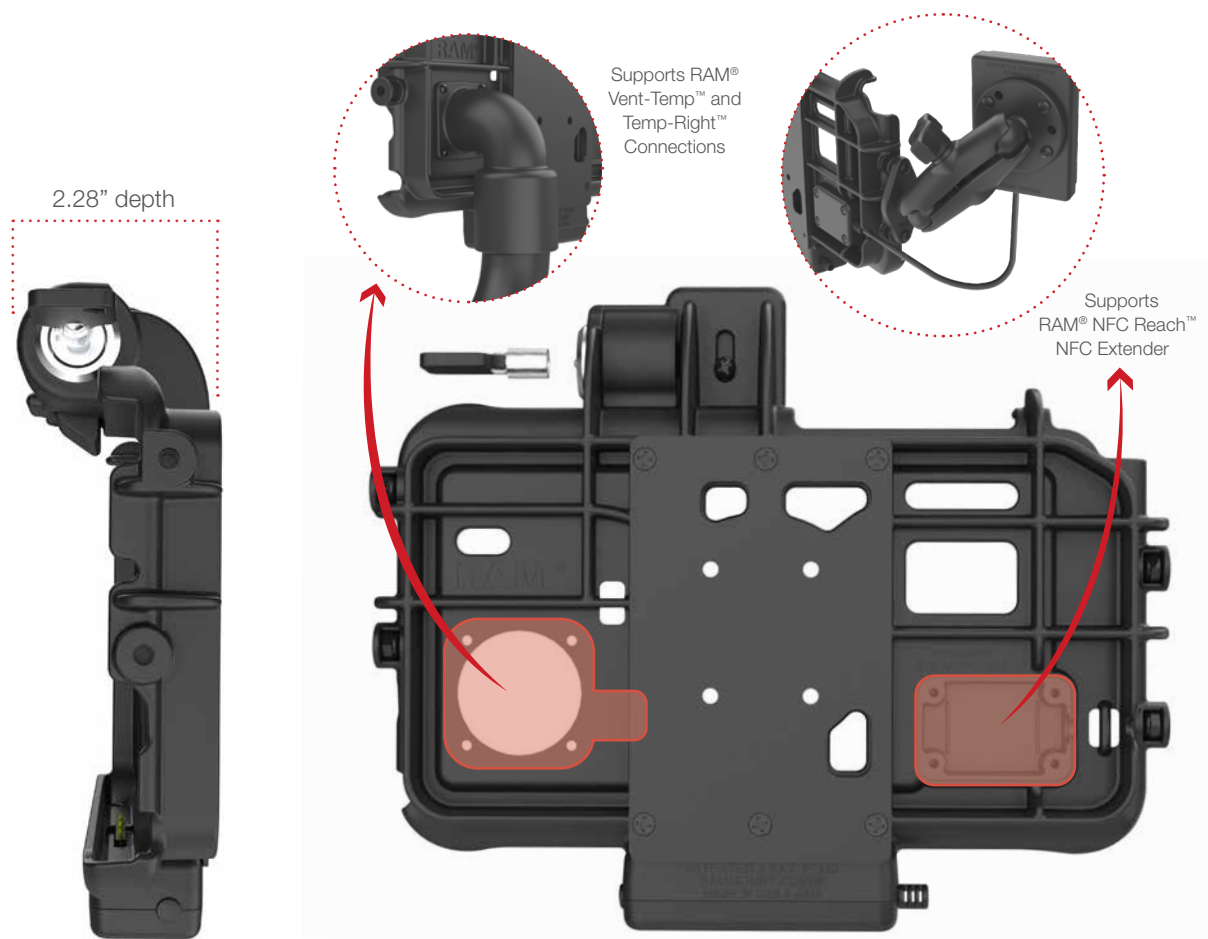

RAM-HOL-SAM58PKLTU
 RAM® Low-Profile Locking Powered Dock for Tab Active3



RAM-HOL-SAM58PDKLTU
 RAM® Low-Profile Locking Power + Single USB Dock for Tab Active3



RAM-HOL-SAM58PD2KLTU
 RAM® Low-Profile Locking Power + Dual USB Dock for Tab Active3

AVAILABLE IN:



KEY LOCK



POWER



POWER + DATA



OTTERBOX UNIVERSE DOCKS

In collaboration with Samsung and OtterBox, RAM® Mounts has designed new form-fit powered docks for the Samsung Galaxy Tab Active3 featuring uniVERSE compatibility. These docks come in both single and dual USB peripheral support—turning your Tab Active3 into a mobile workstation when paired with a GDS® Keyboard™, printer, scanner gun and more, via USB Type-A connectors. Equipped with an OtterBox uniVERSE accessory holder, store and connect uniVERSE modules like the GPS Spike, Square Chip Reader Adapter, and more for an efficient workflow.



RAM-HOL-SAM60PD2-0T1U
RAM® Power + Dual USB Dock
for Tab Active3 with OtterBox
uniVERSE



RAM-HOL-SAM60PD-0T1U
RAM® Power + Data Dock
for Tab Active3 with OtterBox
uniVERSE



RAM-HOL-SAM60P-0T1U
RAM® Powered Dock for
Tab Active3 with OtterBox
uniVERSE

FEATURES



RAM® EZ-Roll'r™ form-fit dock perfectly secures the Tab Active3 with OtterBox uniVERSE making insertion and removal easy



Compatible with B and C size RAM® 4-hole AMPS pattern bases for attaching a double socket arm; ball and socket technology allows for near-infinite adjustability



Integrated pogo pin contacts provide charging power to the device and protects the device's ports from constant plugging and unplugging



These docks include an integrated OtterBox uniVERSE accessory holder on the back of the holder to accommodate any accessory with a uniVERSE module. The additional cavity in the back of the dock allows room for the GDS® Hand-Stand™ and shoulder strap accessories.



SEEN IN THIS PHOTO:

RAM-HOL-SAM61PU
 RAM® Powered Dock for Tab Active3 & 2 with Speaker Box

POWERED DOCKS WITH SPEAKER BOX

Featuring integrated dual speakers for amplified audio, these powered docks for the Samsung Tab Active3 & 2 retain all the same capabilities as the other RAM® EZ-Roll'r™ powered docks, including single and dual USB peripheral support and S pen accessibility. With the built-in hardwire charger, power capabilities are provided to the device through pogo pins. Pair these docks with any RAM® components containing the universal AMPS hole pattern and make the most of your on-the-go solution by connecting GDS® Hand-Stand™ and shoulder strap accessories.



RAM-HOL-SAM61PD2U
 RAM® Power + Dual USB Dock for Tab Active3 & 2 with Speaker Box



RAM-HOL-SAM61PDU
 RAM® Power + Data Dock for Tab Active3 & 2 with Speaker Box



RAM-HOL-SAM61PU
 RAM® Powered Dock for Tab Active3 & 2 with Speaker Box



Integrated dual speakers on the bottom of the dock for amplified audio have a **max volume level of 103dB @ 100mm**



SEEN IN THIS PHOTO:









RAM-HOL-SAM60PD-AUDU

RAM® Powered Dock for Samsung Tab Active3 & 2 with Speaker



PERIPHERAL ENABLEMENT

Connect up to any two USB Type-A peripherals directly to your Tab Active3 & 2, Tab Active4 Pro, and Tab Active Pro Docking Station

-  Scanner
-  Speaker
-  External Memory
-  10-Key Keypad
-  Hub
-  Keyboard
-  Mouse
-  Printer

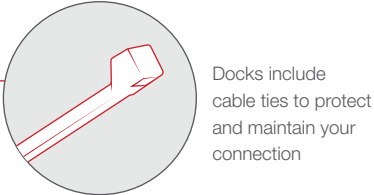

Docks include cable ties to protect and maintain your connection

GDS® KEYBOARD™



RAM-KB4-USB

GDS® Keyboard™ with 10-Key Numeric Pad



RAM-KB2-USB

GDS® Keyboard™ with Track Pad

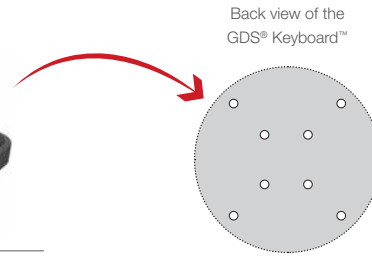

AMPS & VESA hole patterns for any RAM® mount

GDS® AUDIO™



RAM-SPEAK-A02

GDS® Audio™ Amplified Speaker with PTT Breakout Feature



RAP-CAB-USBA-AUD35U

RAM® Audio Adapter Cable - 3.5mm Female Connector to USB Type-A Male

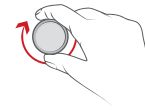

Max volume range: 93dB

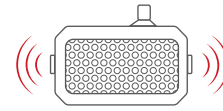

8Ω / 10W rated speaker

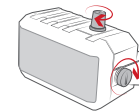

Independently adjustable volume knob

PRINTER SOLUTIONS

UNIVERSAL



RAM-VPR-107

RAM® Printer Cradle for Portable Printers with Rear Paper Feed

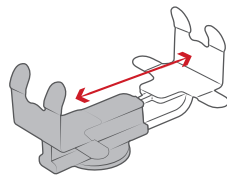

Spring-loaded universal holders offer convenient insertion and removal

FORM-FIT



RAM-VPR-101

RAM® Form-Fit Printer Holder for Brother PocketJet Series

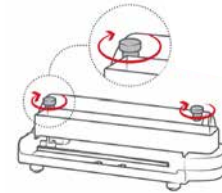

Custom form-fit holders for Brother PocketJet & RuggedJet Series

SCANNER SOLUTIONS



RAP-396U

RAM® Power-Grip™ Scanner Gun Holder



RAP-450U

RAM® Power-Grip™ XL Scanner Gun Holder

Features replaceable elastomeric fins for a secure fit

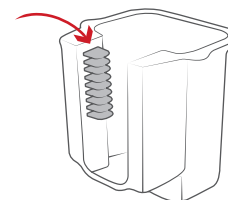



SEEN IN THIS PHOTO:

RAM-HOL-SAM84CP-1U

RAM® EZ-Roll'r™ Powered Dock for XCover6 Pro with OEM or RAM® Skin™



SEEN IN THIS PHOTO:

RAM-HOL-SAM84PU

RAM® EZ-Roll'r™ Powered Dock for Samsung XCover6 Pro Without Case

RAM-B-407-201U

RAM® Tough-Wedge™ Base with Double Socket Arm - Medium

SAMSUNG XCOVER6 PRO & XCOVER 5

RAM® Mounts offers a variety of solutions for Samsung's newest rugged smartphones. Whether you're on the go or in the office, powered accessories are essential for keeping your XCover6 Pro and XCover 5 charged and connected. Protect your investment and improve your workflow with enterprise-ready solutions utilizing IntelliSkin® and GDS® Technology™.



RAM-GDS-SKIN-SAM84

IntelliSkin® for Samsung Galaxy XCover6 Pro



RAM-HOL-SAM84PU

RAM® EZ-Roll'r™ Powered Dock for Samsung XCover6 Pro Without Case



RAM-HOL-SAM84CP-1U

RAM® EZ-Roll'r™ Powered Dock for XCover6 Pro with OEM or RAM® Skin™



RAM-SKIN-SAM84

RAM® Skin™ for Samsung Galaxy XCover6 Pro



RAM-HOL-SAM10PU

RAM® Powered Dock for Samsung XCover 5

COMPATIBLE GDS® DOCKS™



RAM-GDS-DOCK-V1CU
GDS® Vehicle Phone Dock + Data with USB Type-C for IntelliSkin® Products



RAM-GDS-DOCK-6G1PD-NGU
GDS® 6-Port Power Delivery Desktop Charger for IntelliSkin® Next Gen



RAM-GDS-DOCK-D7U
GDS® Desktop Dock with Power Delivery

FEATURES

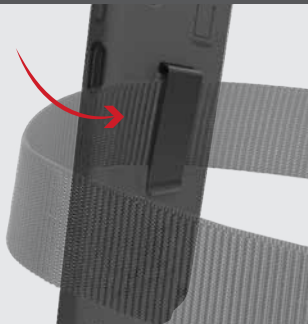

Includes built-in belt clip adapter



Military-grade drop protection to withstand shock and impact



RAM® EZ-Roll'r™ powered dock perfectly secures the Samsung Galaxy XCover6 Pro



When connected to a power source, integrated pogo pins provide charging capabilities to the device



RAM® EZ-Roll'r™ powered dock leaves the device's buttons and cameras exposed and accessible

2-Hole AMPS



Mount your dock anywhere with any B or C size components that are compatible with the 2-hole AMPS hole pattern located on the back



SEEN IN THIS PHOTO:

RAM-HOL-SAM59U

RAM® EZ-Roll'r™ Cradle

RAM-B-238U

RAM® Diamond Ball Base

RAM-B-201U-C

RAM® Double Socket Arm

RAP-B-400U

RAM® Tough-Claw™ Small
Clamp Base with Ball



SEEN IN THIS PHOTO:

RAM-B-166-SAM9PU

RAM® EZ-Roll'r™ Powered
Suction Cup Mount for
Samsung XCover Pro

FEATURES

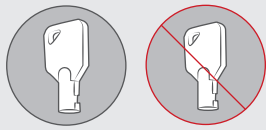

Locking & non-locking options available

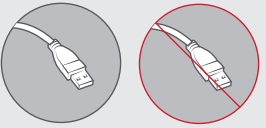

Powered & non-powered options available

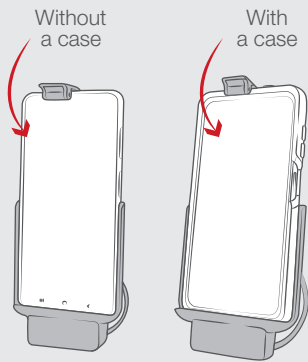

Solutions for XCover Pro with case, without a case, and with an OtterBox uniVERSE case

SAMSUNG XCOVER PRO & FIELDPRO

Both the Samsung XCover Pro & FieldPro take some of the best features of current Tab Active tablets by introducing the pogo-pad technology for charging purposes. RAM® supports these kinds of innovations with pogo-pin enabled powered docks. Of course, with a non-powered option available, the RAM® EZ-Roll'r™ system supports the Samsung XCover Pro without a case as well as an option for OtterBox uniVERSE-wrapped XCover Pros. Simply drop the device into the powered cradle and the aligned pogo-pins to pogo-pads instantly starts charging.

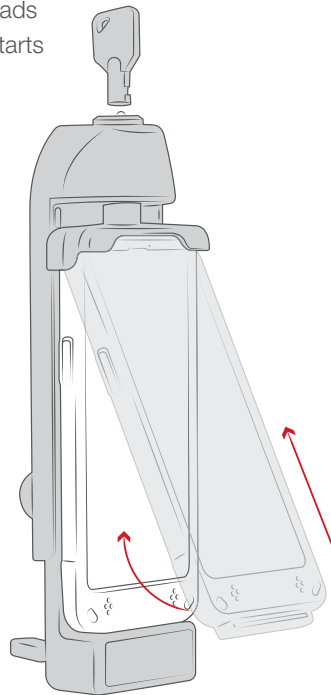

RAM-GDS-DOCKL-V3CU
GDS® Locking Vehicle Phone Dock + Data with USB Type-C for IntelliSkin®



RAM-GDS-SKIN-SAM59
IntelliSkin® for Samsung Galaxy XCover Pro



RAM-HOL-SAM59U
RAM® EZ-Roll'r™ Cradle for Samsung XCover Pro



RAM-HOL-SAM9P-OT2U
RAM® Powered Dock for Samsung XCover Pro with OtterBox uniVERSE



RAM-HOL-SAM9PU
RAM® EZ-Roll'r™ Powered Dock for Samsung XCover Pro



RAM-HOL-SAM72PU
RAM® Powered Dock for Samsung XCover FieldPro



SEEN IN THIS PHOTO:

RAM-DOCK-6G8P-0T1U

RAM® 6-Port Dock for Tab Active4 Pro & Tab Active3 with OtterBox uniVERSE

DESKTOP DOCKS FOR TABLETS

The RAM® 6-Port Charging Dock was designed specifically to support up to six Samsung Galaxy Tab Active4 Pro and Tab Active Pro, Tab Active3 & 2 devices for simultaneous charging. These charging stations reduce the amount of charging cords needed to charge each device by consolidating power through one cord and provide each Samsung tablet with its own charging bay to reduce clutter.



RAM-DOCK-6G8P-0T1U

RAM® 6-Port Dock for Samsung Tab Active4 Pro & Tab Active3



RAM-DOCK-6G8P-0T1U

RAM® 6-Port Dock for Tab Active4 Pro & Tab Active3 with OtterBox uniVERSE

FEATURES

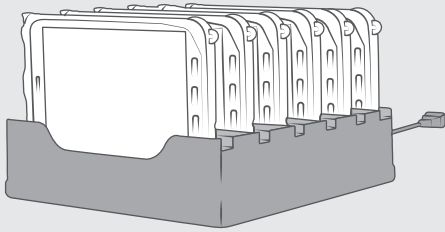

Charges up to six Tab Active4 Pro, Tab Active Pro, Tab Active3 & 2 interchangeably

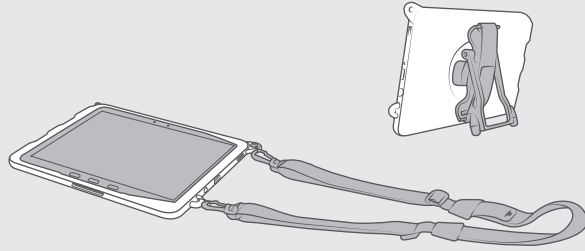

Supports devices with OEM Case, RAM® Skin™, and OtterBox uniVERSE

ADDITIONAL FEATURES

- 1 Integrated pogo-pin contacts match Samsung Tab Active pogo pads for connectivity
- 2 Removable form-fit spacers used for Tab Active3 & 2
- 3 6-Port Dock allows space for ergonomic accessories
- 4 LED lights indicate charge status





SEEN IN THIS PHOTO:

RAM-DOCK-6G-SAM59P-0T1U
RAM® 6-Port Charging Dock for Samsung XCover Pro with OtterBox uniVERSE

DESKTOP DOCKS FOR PHONES

Designed specifically for each Samsung XCover phone model, the RAM® 6-Port Charging Dock supports up to six phones for simultaneous charging. These charging stations reduce the amount of charging cords needed to charge each device by consolidating power through one cord and provide each Samsung phone with its own charging bay.

FEATURES

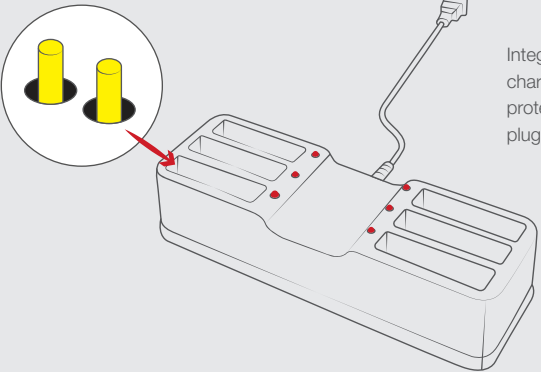

Integrated pogo pin contacts provide charging power to the device and protects the device's ports from constant plugging and unplugging.



Plugs directly into standard wall outlets

RAM-DOCK-6G-SAM59PU
RAM® 6-Port Charging Dock for Samsung XCover Pro



LED lights indicate charge status.



RAM-DOCK-6G-SAM84PU

RAM® 6-Port Charging Dock for Samsung XCover6 Pro without Case



RAM-DOCK-6G-SAM84CPU

RAM® 6-Port Charging Dock for Samsung XCover6 Pro with RAM® Skin™



RAM-DOCK-6G-SAM10PU

RAM® 6-Port Charging Dock for Samsung XCover 5



RAM-DOCK-6G-SAM72PU

RAM® 6-Port Charging Dock for Samsung XCover FieldPro



RAM-DOCK-6G-SAM59P-OT1U

RAM® 6-Port Charging Dock for Samsung XCover Pro with OtterBox uniVERSE

SEEN IN THIS PHOTO:

RAM-GDS-DOCK-D7U

GDS® Desktop Dock with Power Delivery

RAM-GDS-SKIN-SAM74-NG

IntelliSkin® Next Gen for Samsung Tab Active3



DESKTOP DOCKS CONTINUED

GDS® DESKTOP DOCKS™ FOR INTELLISKIN®

Desktop charging stations are also available for IntelliSkin®-wrapped Samsung Galaxy smartphones and tablets. Designed specifically to support the GDS® Ecosystem™ these desktop docks utilize the pogo-pin technology found in all GDS® Docks™ so you can keep a seamless workflow for your organization. These docks successfully reduce the amount of charging cords needed to charge each device by consolidating power through one cord and providing each Samsung phone or tablet with its own charging bay to reduce clutter.

GDS® Docks™ provide scalability as mobile electronics evolve. Their modular design and easy upgrades allow customers to minimize expense when it's time to upgrade their devices



USB Type-A port on the side of the dock for peripheral add-ons turn the desktop dock into a workstation using a keyboard, mouse, or other peripheral



RAM-GDS-DOCK-D7U
 GDS® Desktop Dock with Power Delivery



RAM-GDS-DOCK-D7AU
 GDS® Desktop Dock with Power Delivery & Peripheral Port



RAM-GDS-DOCK-6G1PU
 GDS® 6-Port Desktop Charger for IntelliSkin® Products



RAM-GDS-DOCK-6G1PD-NGU
 GDS® 6-Port Power Delivery Desktop Charger for IntelliSkin® Next Gen



RAM-GDS-DOCK-6G9PU
 GDS® 6-Port Desktop Charger for Phones with IntelliSkin®

FEATURES

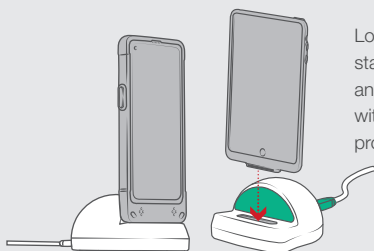

Low-profile docking station for phones and tablets equipped with an IntelliSkin® protective case

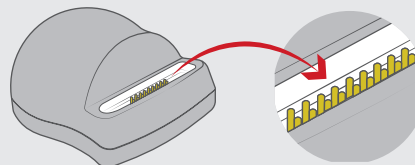

Desktop Docks feature pogo pin contacts designed to match the pogo pads on IntelliSkin®-wrapped devices supporting USB Type-C data transfer and charging profiles

SEEN IN THIS PHOTO:

RAM-SKIN-SAM29

RAM® Skin™ for Samsung
Tab Active2

RAM-GDS-HS1U

GDS® Hand-Stand™ Hand Strap and Kickstand for Tablets



SEEN IN THIS PHOTO:

RAM-SKIN-SAM73

RAM® Skin™ for Samsung Tab Active3

RAM-GDS-SS1U

GDS® Shoulder Strap Accessory for IntelliSkin® Products

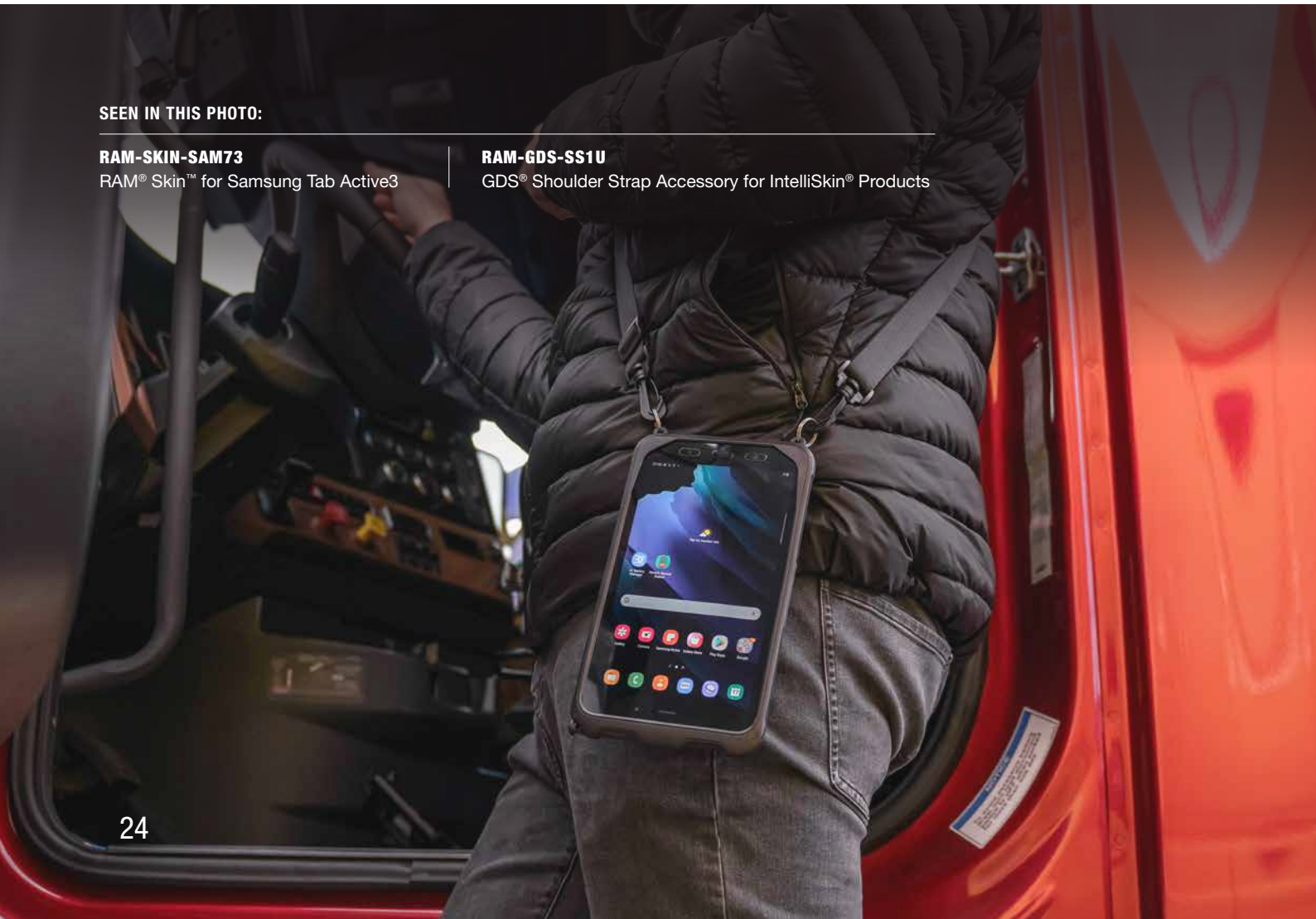

RAM® SKIN™

This RAM® Skin™ was designed specifically for the Samsung Tab Active Pro, Tab Active4 Pro, Tab Active3 & 2. It features MIL-STD-810G military-grade drop protection and a built-in S Pen holder. Made for rugged use in a variety of applications, the RAM® Skin™ is ideally paired with the GDS® Hand-Stand™ tablet hand strap and kickstand as well as the GDS® shoulder strap accessory.



RAM-SKIN-SAM29
RAM® Skin™ for Samsung Tab Active2



RAM-SKIN-SAM52-1
RAM® Skin™ for Samsung Tab Active4 Pro & Tab Active Pro



RAM-SKIN-SAM73
RAM® Skin™ for Samsung Tab Active3



RAM-SKIN-SAM84
RAM® Skin™ for Samsung Galaxy XCover6 Pro



Protective sleeve features military-grade drop protection and a built-in S Pen holder

FEATURES

Built-in S Pen holder

Made of durable polycarbonate and thermoplastic elastomers

Compatible with a range of feature-rich RAM® holders

SEEN IN THIS PHOTO:

RAM-GDS-SKIN-SAM63-NG-LED

IntelliSkin® Next Gen with LED Light for
Samsung Tab A 8.0 (2018)



INTELLISKIN®

IntelliSkin® is a protective sleeve for phones and tablets featuring GDS® Tech™ with pogo pin technology and military-grade drop protection. With an integrated GDS® connector molded directly into each skin and ruggedized docking contacts on each skin's exterior, IntelliSkin® is designed to extend the life of devices by preventing damage to the charging port from repetitive docking.

The IntelliSkin® Next Gen protective sleeve includes all the great features of the original IntelliSkin® while adding several enhancements. An insert molded redesign of the skin combines a hard plastic shell with soft, shock-absorbing rubber. Ruggedized contacts for repetitive docking remain on the exterior, but are now flat to collect less dirt and allow for easier cleaning. An integrated USB Type-C connector at the bottom of the skin allows for device charging even when you don't have a GDS® Dock™ available.



RAM-GDS-SKIN-SAM84
IntelliSkin® for Samsung Galaxy XCover6 Pro

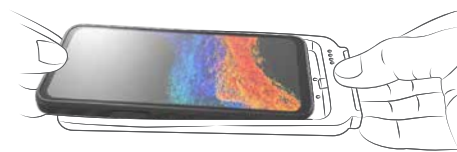

RAM-GDS-SKIN-SAM54-NG-1
IntelliSkin® Next Gen for Samsung Tab Active4 Pro & Tab Active Pro



Molded ruggedized docking contacts on the exterior of the skin are designed for repetitive docking in field applications

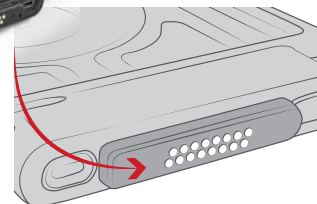

FEATURES



Military-grade drop protection to withstand shock and impact

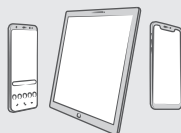

Pogo pin technology allows for any IntelliSkin®-wrapped device to work within the GDS® Ecosystem™



Built-in external LED light available with a button on the front of the IntelliSkin®



Connect multiple peripherals to your mounting solution and gain instant access when device is docked

MODEL	INTELLISKIN®	NOTES
Galaxy A20	RAM-GDS-SKIN-SAM61	
Galaxy S20 FE 5G	RAM-GDS-SKIN-SAM77	
Tab A 8.4"	RAM-GDS-SKIN-SAM67-NG	
Tab A 8.4"	RAM-GDS-SKIN-SAM67-NG-LED	Built-in Flashlight
Tab A7 10.4"	RAM-GDS-SKIN-SAM75-NG	
Tab A7 10.4"	RAM-GDS-SKIN-SAM75-NG-LED	Built-in Flashlight
Tab A7 Lite 8.7"	RAM-GDS-SKIN-SAM80-NG	
Tab A7 Lite 8.7"	RAM-GDS-SKIN-SAM80-NG-LED	Built-in Flashlight
Tab A8 10.5"	RAM-GDS-SKIN-SAM83-NG	
Tab A8 10.5"	RAM-GDS-SKIN-SAM83-NG-LED	Built-in Flashlight
Tab Active4 Pro	RAM-GDS-SKIN-SAM54-NG-1	
Tab Active Pro	RAM-GDS-SKIN-SAM54-NG-1	
Tab Active3	RAM-GDS-SKIN-SAM74-NG	
Tab S7 11"	RAM-GDS-SKIN-SAM76-NG	
Tab S7+ & S7 FE 12.4"	RAM-GDS-SKIN-SAM78-NG	
XCover Pro	RAM-GDS-SKIN-SAM59	
XCover6 Pro	RAM-GDS-SKIN-SAM84	



SEEN IN THESE PHOTOS:

RAM-GDS-ROT02U

GDS® Roto-Mag™ 3-in-1 Accessory with Grip Handle, Hand Strap & Magnets



RAM® SKIN™ & INTELLISKIN® ACCESSORIES

The RAM® Skin™ and IntelliSkin® product lines are compatible with a variety of GDS® Ergo™ accessories that enable your tablet for field use. Make traveling with your tablet more comfortable and efficient by pairing your device with the GDS® Hand-Stand™—this combination hand strap and kickstand accessory allows you to take your device from the warehouse to the office and everywhere in between. Take advantage of mounting your tablet to magnetic surfaces with the GDS® Roto-Mag™ and the magnetic version of the GDS® Hand-Stand™.



RAM-GDS-HS1U
 GDS® Hand-Stand™ Hand Strap and Kickstand for Tablets



RAM-GDS-ROT02U
 GDS® Roto-Mag™ 3-in-1 Accessory with Grip Handle, Hand Strap & Magnets



RAM-GDS-HS1MU
 GDS® Hand-Stand™ Magnetic Hand Strap and Kickstand for Tablets



RAM-GDS-SS1U
 GDS® Shoulder Strap Accessory for IntelliSkin® Products



While the GDS® Roto-Mag™ fits both RAM® Skin™ and IntelliSkin®, it will not fit in the RAM® Skin™ Form-Fit docks

FEATURES

Rotate between portrait and landscape mode with the GDS® Roto-Mag™

Use the GDS® Hand-Stand™ as a hand strap or as a kickstand when the tablet is stationary

Connect the GDS® Shoulder Strap to your RAM® Skin™ or IntelliSkin®-wrapped device with the corner attachment points



SEEN IN THIS PHOTO:

RAM-GDS-SKIN-SAM54-NG-1
IntelliSkin® Next Gen for Samsung
Tab Active4 Pro & Tab Active Pro

RAM-GDS-DOCKL-V9-OMT1U
GDS® Type-C Vehicle Dock for
IntelliSkin® Next Gen Tablets

RAM-VB-195-SW2
RAM® No-Drill™ Mount for '15-23
Ford F-150, '17-22 F-250 + More

FEATURES



USB Type-C Docks provide fast charging

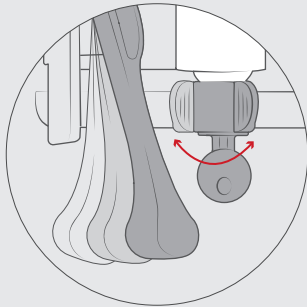

Key-locking

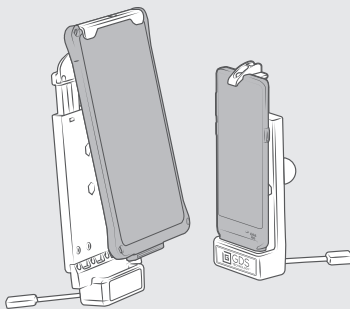

Compatible with any RAM® phone & tablet mounts

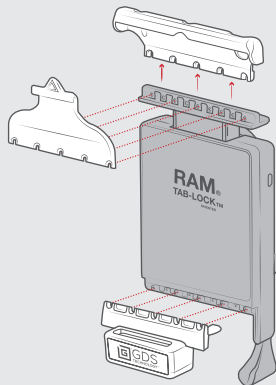

Interchangeable top cups

GDS® VEHICLE DOCKS

GDS® Vehicle Docks offer a universal charging platform for any device wrapped in an IntelliSkin® sleeve. IntelliSkin® offers drop protection and uses ruggedized external contacts to allow for repetitive docking, with no need to deal with charging cables. The main advantage of GDS® Vehicle Docks is the interchangeable top and bottom cups. Simply switch out either cup depending on the device you plan on docking instead of purchasing new docks. New top cups for IntelliSkin® Next Gen-wrapped devices feature universal positioning marker for a clean docking experience.



RAM-GDS-DOCKL-V9-OMT1U
GDS® Type-C Vehicle Dock for IntelliSkin® Next Gen Tablets

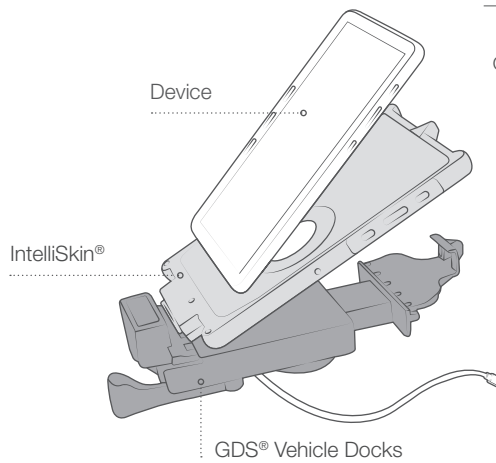

RAM-GDS-DOCK-V1CU
GDS® Vehicle Phone Dock with USB Type-C for IntelliSkin® Products



RAM-GDS-DOCKL-V10-OMT1U
GDS® Type-C Powered Vehicle Dock for IntelliSkin® Next Gen Tablets



RAM-GDS-DOCKL-V3CU
GDS® Locking Vehicle Phone Dock with USB Type-C for IntelliSkin®



RAM-GDS-DOCKL-V3CPU
GDS® Locking Vehicle Phone Dock with USB Type-C for IntelliSkin®

SEEN IN THIS PHOTO:

RAM-GDS-SKIN-SAM54-NG-1
IntelliSkin® Next Gen for Samsung
Tab Active4 Pro & Tab Active Pro

RAM-GDS-DOCKLF-SAM54CU
Locking GDS® Cool-Dock™ + Data
Sync for Samsung Tab Active4 Pro

RAM-VB-195-SW2
RAM® No-Drill™ Mount for '15-23
Ford F-150, '17-22 F-250 + More



SEEN IN THIS PHOTO:

RAM-GDS-101B2-SAM80CP-V7B1U
GDS® Tough-Dock™ Vehicle Bundle
for Samsung Tab A7 Lite 8.7"



GDS® TOUGH-DOCK™

The GDS® Tough-Dock™ is the newest vehicle docks in the GDS® Tech™ line of vehicle docks designed to support select Samsung Galaxy tablets in an IntelliSkin® Next Gen protective sleeve for your fleet. Take advantage of a USB Type-C connector, supporting data sync, and fast charging capabilities.

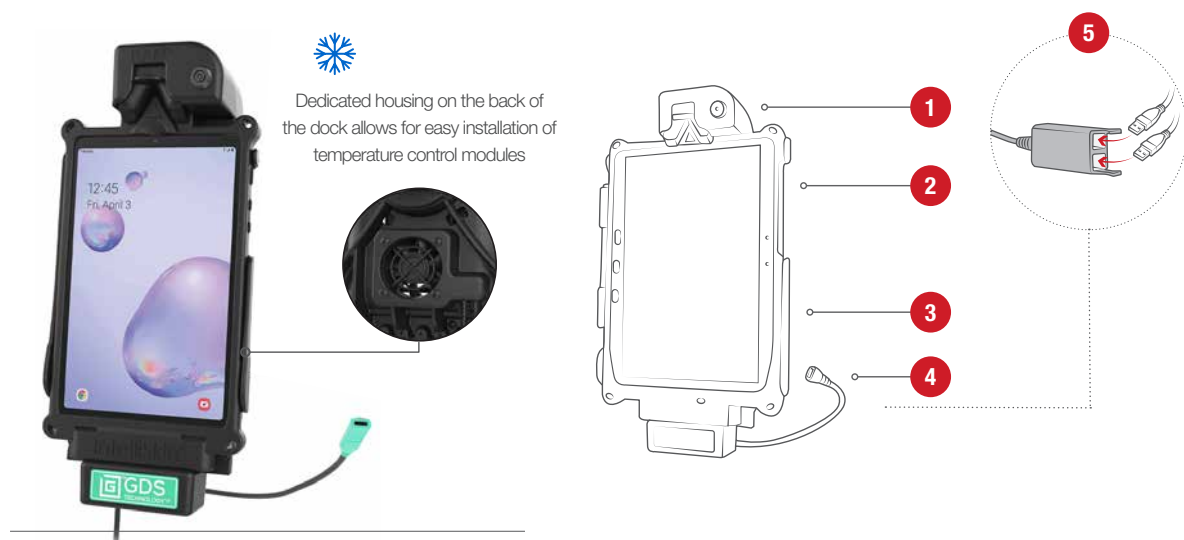

RAM-GDS-DOCKLF-SAM67CPU

Locking GDS® Cool-Dock™ with USB Type-C for Samsung Tab A 8.4 SM-T307

FEATURES

- 1 LOCKING & NON-LOCKING**

Secure your device for theft deterrence with a key-locking option available for all GDS® Tough-Dock™ and GDS® Cool-Dock™ models.



- 2 GDS® HAND-STAND™ COMPATIBLE**

The GDS® Tough-Dock™ and GDS® Cool-Dock™ have integrated space for GDS® Hand-Stand™ attachments on the back of your IntelliSkin® Next Gen-wrapped device.



- 3 TEMPERATURE ACCESSORY-READY**

Dedicated housing on the back of the dock allows for easy installation of temperature control modules such as the RAM® Vent-Temp™, RAM® Temp-Right™, and GDS® 12V Axial Cooling Fan.



- 4 STANDARD & HIGH SPEED POWER OPTIONS**

All GDS® Tough-Dock™ and GDS® Cool-Dock™ models are available in and support USB Type-C connections.



- 5 CONNECT YOUR KEYBOARD & OTHER PERIPHERALS**

Customize your mobile workstation with peripheral add-ons that help improve your workflow. The GDS® Ecosystem™ makes it easy to choose different peripherals designed to work perfectly with the GDS® Tough-Dock™ and GDS® Cool-Dock™.





SEEN IN THESE PHOTOS:

RAM-HOL-SAM60P-NFCU

RAM® Powered Dock for Tab Active3
with RAM® NFC Reach™

RAM-101-225B2U

RAM® Drill-Down Dashboard Mount
with Backing Plate - C Size Medium



NFC ATTACHMENT METHODS

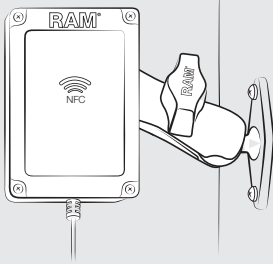

Double Ball Mount: Flat Surface

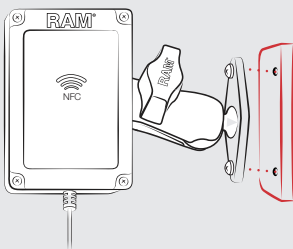

Double Ball Mount: Direct-to-Dock

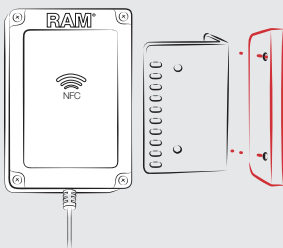

Direct-to-Dock: 90° Bracket

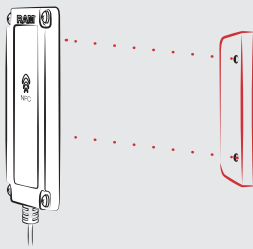

Direct-to-Dock: Low-Profile

RAM® NFC REACH™

RAM® Mounts takes NFC scanning to the next level with the brand new RAM® NFC Reach™ by adding an NFC repeater to your Samsung Galaxy Tab Active3. With this NFC repeater, tablet operators no longer need to remove the device from its docking station to scan—simply install the repeater on your docking station and give easy access to programs like tap-to-pay, asset tracking, time management, and more.

Choose from four mounting options for the NFC Repeater

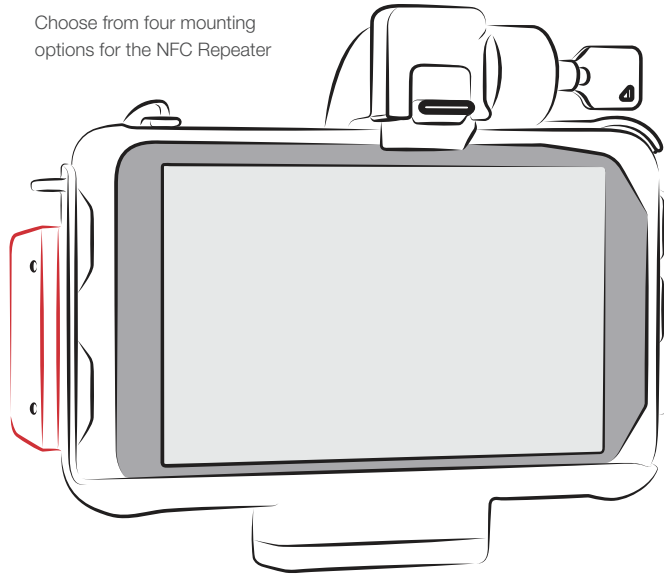

RAM-HOL-SAM60P-NFCU

RAM® Powered Dock for Tab Active3 with RAM® NFC Reach™



RAM-HOL-SAM58PKL-NFCU

RAM® Locking Powered Dock for Tab Active3 with RAM® NFC Reach™



RAM-GDS-DOCKB-SAM62-NFCU

GDS® Tough-Dock™ Body for Tab Active3 with RAM® NFC Reach™



RAM-GDS-DOCK-SAM62CP-NFCU

GDS® Tough-Dock™ for Tab Active3 with RAM® NFC Reach™



RAM-GDS-DOCKL-SAM62CP-NFCU

Locking GDS® Tough-Dock™ for Tab Active3 with RAM® NFC Reach™



SEEN IN THESE PHOTOS:

RAM-GDS-DOCKL-SAM62CPU

Locking GDS® Tough-Dock™ with USB Type-C for Tab Active3 & 2

RAM-VENT1-RCT-50U

RAM® Vent-Temp™ with Back Dock Connection for Rectangular Vents



TEMPERATURE CONTROL PRODUCTS

Located at the back of your dock is an empty housing for upgrading your mounting solution. This housing can accommodate various temperature modules provided by RAM® Mounts. Easily install either the RAM® Vent-Temp™, which connects to your vehicle's A/C vents or the RAM® Temp-Right™, which provides regulated heat in extremely cold environments.

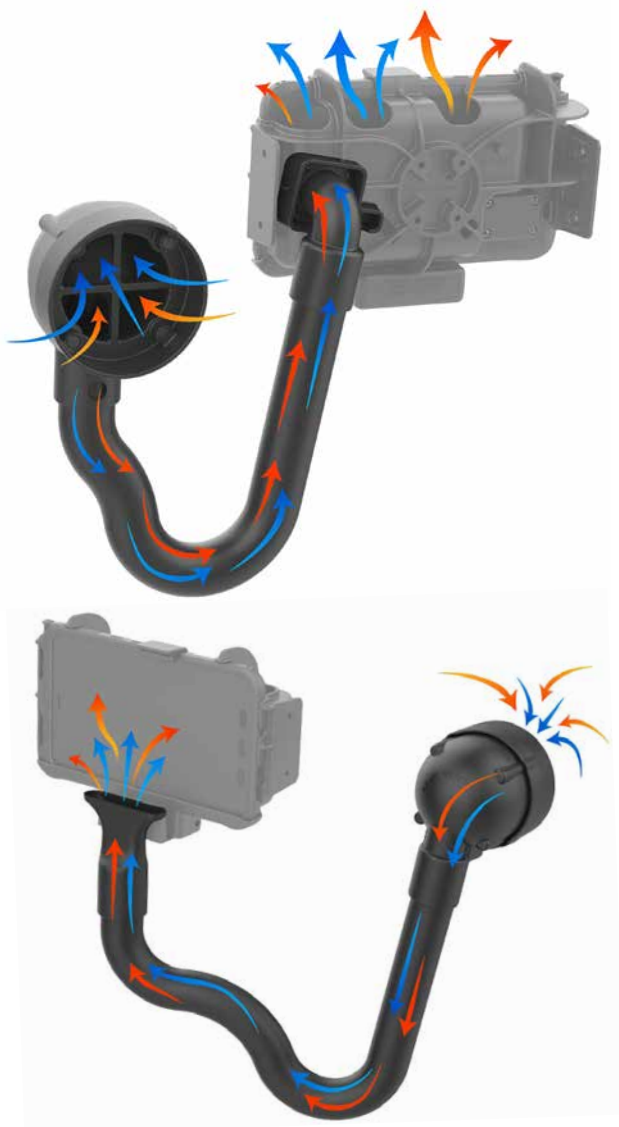

RAM® VENT-TEMP™ BACK NOZZLE ATTACHMENT

Hot or cold air from your vehicle's air system enters through the RAM® Temp-Right™ nozzle, travels through flexible tube, and exits behind the docked tablet.

RAM-VENT1-RCT-50U

RAM® Vent-Temp™ with Back Dock Connection for Rectangular Vents

RAM-VENT1-RND-50U

RAM® Vent-Temp™ with Back Dock Connection for Round Vents

RAM® VENT-TEMP™ FRONT NOZZLE ATTACHMENT

Hot or cold air from your vehicle's air system enters through the RAM® Temp-Right™ nozzle, travels through flexible tube, and exits in front of the docked tablet.

RAM-VENT2-RCT-50U

RAM® Vent-Temp™ with Front Dock Connection for Rectangular Vents

RAM-VENT2-RND-50U

RAM® Vent-Temp™ with Front Dock Connection for Round Vents

FEATURES

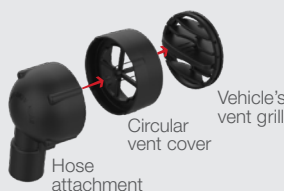

Vent cover attaches directly to circular vents using zip ties
 Hose attachment includes built-in magnets for easy break-away when not in-use

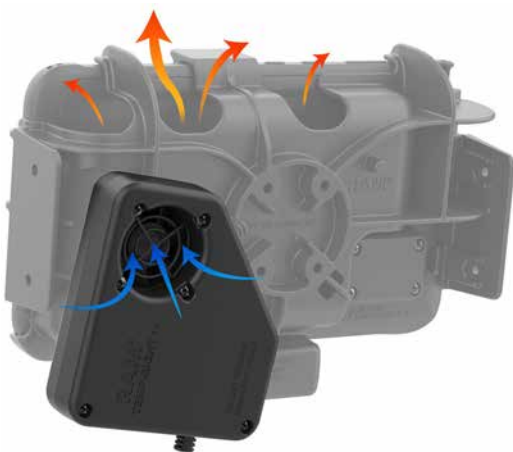

RAM® TEMP-RIGHT™

The RAM® Temp-Right™ heater module regulates device temperatures to maintain functionality in extreme cold environments and contains integrated 11-16VDC hardware charger. Cabin air gets sucked through Temp-Right™ fan and through the module, heating the air up to the right temperature needed for tablet functionality.

RAM-DOCK-HEATER1-BU

RAM® Temp-Right™ Dock Heating Module for GDS® Tough-Dock™

RAM-DOCK-HEATER1-CU

RAM® Temp-Right™ Dock Heating Module for Samsung Tab Active3



SEEN IN THIS PHOTO:

RAM-TC-SAM29U

RAM® Tough-Case™ with USB Type-A for Samsung Tab Active3 & 2

FEATURES



Oversized strain relief protects cable connection



Open enclosure on front and back allows heat to flow from device.

RAM® TOUGH-CASE™

The RAM® Tough-Case™ is a rugged two-piece enclosure with a built-in coiled power cable that tethers the device inside of any vehicle. This case allows you to create a hardwired connection to the tablet using a custom USB Type-C connector with a stretch of up to 7 feet, which offers maximum tablet mobility while staying connected. Your connection will remain secured and protected with the use of oversized strain relief built into the RAM® Tough-Case™ making this the ideal ELD mounting solution for current Samsung tablets.

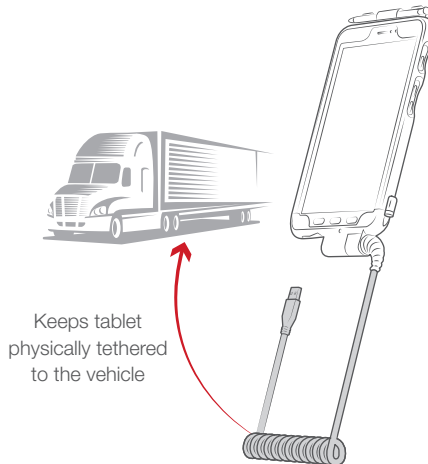

RAM-TC-SAM29U
RAM® Tough-Case™ with USB Type-A for Samsung Tab Active3 & 2



RAM-TC-SAM29U

RAM® Tough-Case™ with USB Type-A for Samsung Tab Active3 & 2



RAM-TC-SAM29CU

RAM® Tough-Case™ with USB Type-C for Samsung Tab Active3 & 2



RAM-TC-SAM54U

RAM® Tough-Case™ for Samsung Tab Active Pro - Type-A Male USB



RAM-TC-SAM54CU

RAM® Tough-Case™ for Samsung Tab Active4 Pro - Type-C Male USB



RAM-TC-SAM67-387U

RAM® Tough-Case™ for Samsung Tab A 8.0 (2018) SM-T387



RAM-TC-SAM67-307U

RAM® Tough-Case™ for Samsung Tab A 8.4 SM-T307



RAM-TC-SAM67-290U

RAM® Tough-Case™ for Samsung Tab A 8.0 (2019) SM-T290



RAM-TC-SAM50U

RAM® Tough-Case™ for Samsung Tab A 10.1, Tab A7 10.4 & Tab S6 LITE 10.4

CHARGERS FOR USB TYPE-A



RAM-GDS-CHARGE-V7B1U

GDS® Modular 10-30V Hardwire Charger with Female USB Type-A Connector



RAM-GDS-CHARGE-USB2QCCIG

GDS® 2-Port USB Cigarette Charger with Qualcomm® Quick Charge™

POWER DELIVERY CHARGERS WITH USB TYPE-C



RAM-GDS-CHARGE-V3FC-1U

GDS® Hardwire USB Type-C Power Delivery Charger



RAM-GDS-CHARGE-V3FCA-1U

GDS® Hardwire Charger with USB Type-C Connector & USB Type-A Port



RAM-GDS-CHARGE-V3FCA2-1U

GDS® Hardwire Charger with USB Type-C & Dual USB Type-A Ports



RAM-GDS-CHARGE-CIGC

GDS® Type-C and Type-A 2-Port Cigarette Charger



SEEN IN THIS PHOTO:

RAM-HOL-TC-SAM29FU
RAM® Tough-Case™ Holder with Fan
for Samsung Tab Active3 + More



RAM® TOUGH-CASE™ CONTINUED

RAM® TOUGH-CASE™ HOLDER

To accommodate the RAM® Tough-Case™-wrapped device, an appropriate form-fit cradle snaps it into place with ports and S pen holder exposed for full access to your Samsung tablet. Equipped with a built-in fan, this holder combats high temperature environments as well as overheating. With the RAM® Tough-Case™ holder taking up minimal space, this solution is ideal for ELD mounting.

FOR TAB ACTIVE3 & 2, TAB A 8.0, TAB A 8.4



RAM-HOL-TC-SAM29FU
RAM® Tough-Case™ Holder with Fan
for Samsung Tab Active3 + More

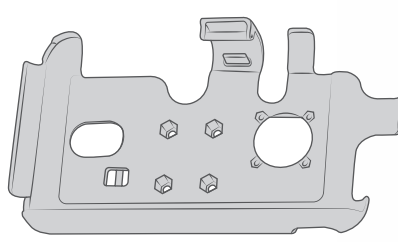

RAM-HOL-TC-SAM29U
RAM® Tough-Case™ Holder without Fan
for Samsung Tab Active3 + More

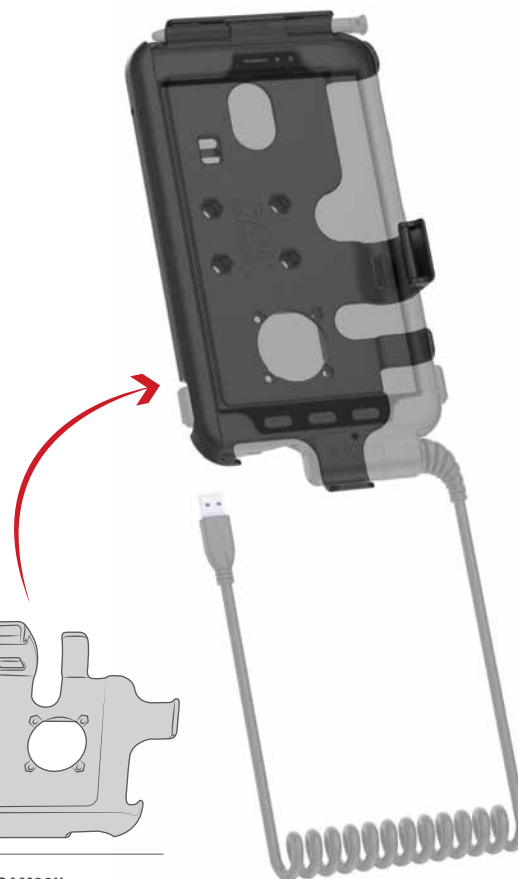

FOR TAB ACTIVE PRO, TAB A 10.1, TAB A7 10.4 & TAB S6 LITE



RAM-HOL-TC-SAM54FU
RAM® Tough-Case™ Holder with Fan
for Samsung Tab Active4 Pro & Tab Active Pro



RAM-HOL-TC-SAM54U
RAM® Tough-Case™ Holder without Fan
for Samsung Tab Active4 Pro & Tab Active Pro

UNIVERSAL HOLDERS

RAM® TAB-TITE™ & TAB-LOCK™

The RAM® Tab-Tite™ & Tab-Lock™ are rugged, universal tablet holders that are available in locking and non-locking options, can support tablets with or without a case, and can be mounted virtually anywhere. The spring-loaded design makes it easy to insert and remove your tablet while keeping it secure. The RAM® Tab-Tite™ & Tab-Lock™ product lines are future-proof—simply modify the holder with interchangeable top and bottom cups when upgrading your device.



RAM-HOL-TABL-SAM29U
RAM® Tab-Lock™
Holder for Samsung
Tab Active3 & 2

RAM-HOL-TAB-SAM29U
RAM® Tab-Tite™ Holder
for Samsung Tab Active3 & 2



RAM-VB-195-TAB20
RAM® Tab-Tite™ 9-10.5"
Tablet Mount for '15-23
Ford F-150, F-250 + More



RAM-101B2-TAB20U
RAM® Dashboard Mount with Backing Plate
for 9"-10.5" Tablets with Cases



RAM-B-138-TAB4-225B2U
RAM® Tab-Tite™ Drill-Down Mount
with Backing Plate for Small Tablets



RAM-HOL-TABL20U
RAM® Tab-Lock™
Holder for 9"-10.5"
Tablets with Heavy
Duty Cases

RAM-HOL-TAB20U
RAM® Tab-Tite™ Holder for 9"-10.5" Tablets
with Heavy Duty Cases



RAM-HOL-TABL4U
RAM® Tab-Lock™
Spring Loaded Holder
for 7"-8" Tablets
with Cases

RAM-HOL-TAB4U
RAM® Tab-Tite™ Spring Loaded Holder
for 7"-8" Tablets with Cases



RAM-HOL-TABL33U
RAM® Tab-Lock™
Holder for 10.1"-10.5"
Tablets with or
without Case

RAM-HOL-TAB33U
RAM® Tab-Tite™ Holder for 10.1"-10.5" Tablets
with or without Case



SEEN IN THIS PHOTO:

RAM-HOL-TAB-SAM29U

RAM® Tab-Tite™ Holder for Samsung Tab Active3 & 2

FEATURES

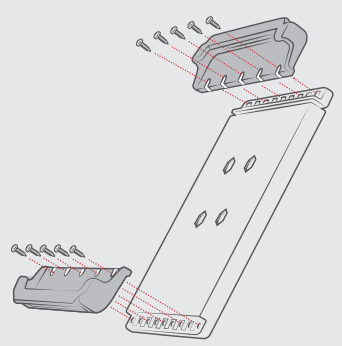

Interchangeable cups support any tablet

Non-locking and locking options available

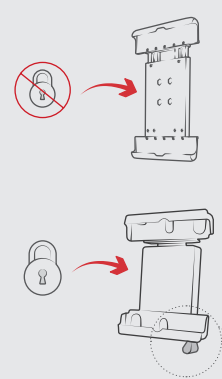

Locking mechanism for theft deterrence

Supports tablets in portrait and landscape mode

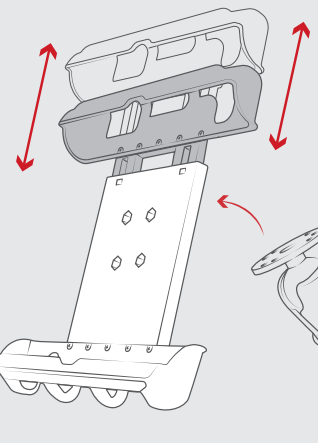
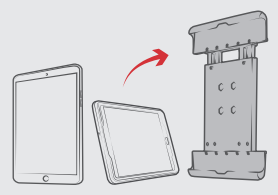

Adjustable to secure your tablet



Made of high-strength composite for durability and reliability in the most demanding environments

SEEN IN THIS PHOTO:

RAM-HOL-UN9U

RAM® X-Grip® Holder
for 9"-10" Tablets



RAM-HOL-UN9U

RAM® X-Grip® Universal Holder
for 9"-10" Tablets

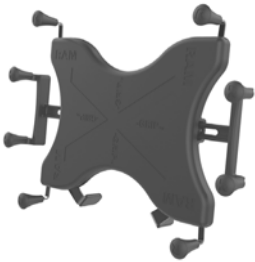

RAM-HOL-UN11U

RAM® X-Grip® Universal Holder
for 12" Tablets



RAM-HOL-UN8BCU

RAM® X-Grip® Universal Holder
for 7"-8" Tablets with Ball

UNIVERSAL HOLDERS CONTINUED
RAM® X-GRIP®

Using a tablet for in-vehicle navigation and mobile work is on the rise. The RAM® X-Grip® for tablets holds all the benefits and design features of the standard X-Grip® with added arm support for a variety of different size tablets with or without a case. Additional grip handles provide side support for portrait or landscape orientation and are completely removable. Protect your investment with the highly rugged X-Grip® and be sure your device will stand the test of time in the harshest environments.

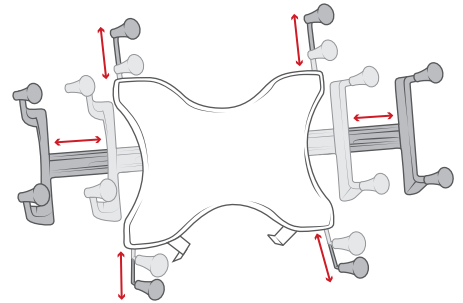

Additional grip handles for convenient insertion and removal

FEATURES

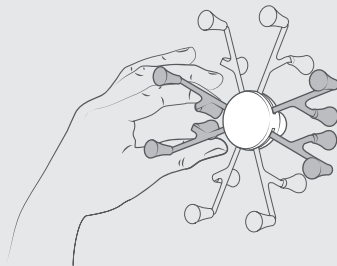

Highly adjustable to support tablets in portrait and landscape mode



Fits all tablets 7"-12" with or without a case

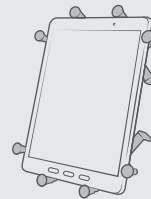

Steel spring-loaded arms keep tablets secure

SEEN IN THIS PHOTO:

RAP-B-299-4-UN8U

RAM® X-Grip® for 7"-8" Tablets with
RAM® Stubby™ Cup Holder Base

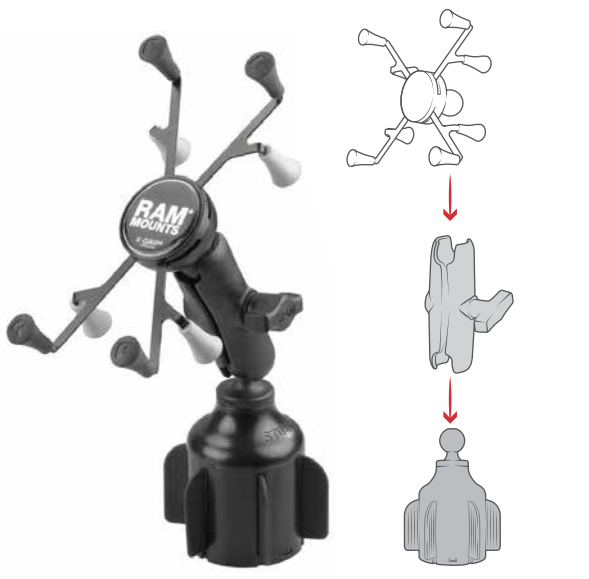

RAP-B-299-4-UN8U

RAM® X-Grip® for 7"-8" Tablets
with RAM® Stubby™ Cup Holder Base



RAM-HOL-UN7BU
RAM® X-Grip® Universal Small
Phone Holder with Ball



RAM-HOL-UN10BU
RAM® X-Grip® Universal Large
Phone Holder with Ball



RAM-101B2-UN9U

RAM® X-Grip® Dashboard Mount with
Backing Plate for 9"-10" Tablets



RAM-VB-195-UN9

RAM® X-Grip® 9"-10" Tablet Mount for
'15-23 Ford F-150, F-250 + More



RAM-400-B-UN8U

RAM® X-Grip® with Tough-Claw™
Mount for 7"-8" Tablets



SEEN IN THIS PHOTO:

RAM-VB-196-GDS-EC01

GDS® Ecosystem™ Vehicle Bundle with Monitor, Keyboard & Phone Mount

SAMSUNG DEX IN-VEHICLE

RAM® Mounts has partnered with Samsung to support the Samsung DeX platform by enabling the system in-vehicle. Samsung DeX allows you to consolidate your workflow through a Samsung phone while RAM® Mounts allows you to transform your vehicle into a mobile workstation with the help of familiar peripherals that emulate a desktop experience.

The GDS® Ecosystem™ Bundle is the all-in-one solution for introducing Samsung DeX into your workflow. This bundle includes a GDS® View™ 13.3" touchscreen monitor, a GDS® Keyboard™, display bracket, universal vehicle mount, phone mount, and hardwire chargers to transform your vehicle into a mobile office. Simply insert your DeX-enabled Samsung phone and connect your device to the workstation so you can work on the go.

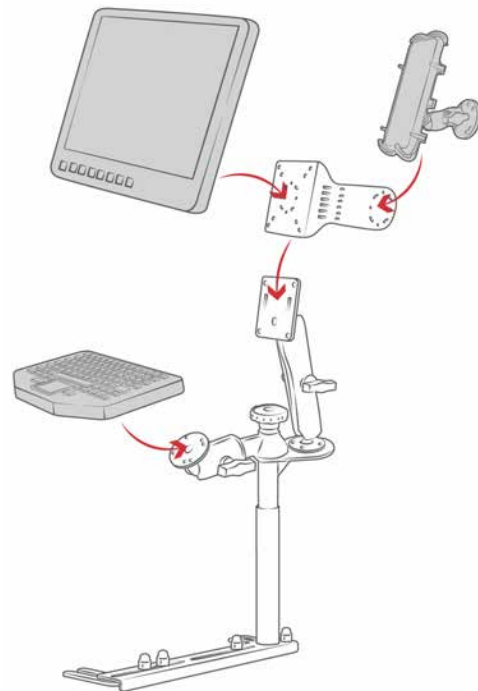

RAM-VB-196-GDS-EC01

GDS® Ecosystem™ Vehicle Bundle with Monitor, Keyboard & Phone Mount

SEEN IN THIS PHOTO:

RAM-HOL-SAM60PU

RAM® EZ-Roll'r™ Powered Dock for Samsung Tab Active3 & 2

RAM-101U-247-4

Square Post Clamp Mount





RAM-HOL-SAM59U
RAM® EZ-Roll'r™ Cradle for Samsung XCover Pro

RAM-B-166U
RAM® Twist-Lock™ Suction Cup Double Ball Mount



RAM-HOL-SAM59U
RAM® EZ-Roll'r™ Cradle for Samsung XCover Pro

RAP-B-400-238U
RAM® Tough-Claw™ Small Clamp Mount with Diamond Plate

POPULAR RAM® MOUNTS

TABLET MOUNTS UNIVERSAL



RAM-101-B-225B2U
RAM® Drill-Down Dashboard Mount with Backing Plate



RAM-101U-247-4
RAM® 4" Square Post Clamp Mount with Round AMPS Plate



RAP-401-202U
RAM® Tough-Claw™ Large Clamp Double Ball Mount with Round Plate

TABLET MOUNTS RAM® NO-DRILL™ VEHICLE FLOOR MOUNTS



RAM-VB-203-SW2
'19-23 Chevy Silverado + More



RAM-VB-178A-SW2
'12-23 RAM 2500-5500 + More

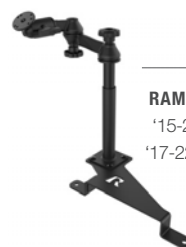

RAM-VB-195-SW2
'15-23 Ford F-150, '17-22 F-250 + More

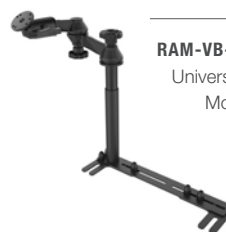

RAM-VB-196-SW2
Universal Floor Mount

PHONE MOUNTS



RAM-B-166U
RAM® Twist-Lock™ Suction Cup Mount



RAM-B-138U
Double Ball Drill-Down Mount



RAM-B-149ZU
U-Bolt Rail Mount



RAP-B-400-238U
RAM® Tough-Claw™ Clamp Mount



RAP-B-299-4-238U
RAM® Stubby™ Cup Holder Mount



RAM-B-408-75-1-238U
RAM® Torque™ Rail Mount



RAP-B-378-238U
Flex Adhesive Double Ball Mount



RAM-B-121-238U
Double Ball Yoke Clamp Mount

SEEN IN THIS PHOTO:

RAM-HOL-SAM60PU

RAM® EZ-Roll'r™ Powered Dock for Samsung
Tab Active3 & 2



TRANSPORTATION BUNDLES

RAM® Mounts offers the perfect mounting solutions for your ELD to meet all mandate compliance. We understand you don't always need the extensive customization RAM® offers, so we went ahead and put together turnkey solutions for your chosen device.

RAM® EZ-ROLL'R™



RAM-101-B2-SAM52P-V7B1U
 RAM® Powered Mount for Samsung Tab Active4 Pro with Backing Plate



RAM-B-101-225B2-SAM60P-V7B1U
 RAM® EZ-Roll'r™ Powered Mount for Samsung Tab Active3 & 2

GDS® TOUGH-DOCK™



RAM-GDS-101B2-SAM80CP-V7B1U
 GDS® Tough-Dock™ Vehicle Bundle for Samsung Tab A7 Lite 8.7"

RAM® TOUGH-CASE™



RAM-101B2-TC-SAM54C-V3FCU
 RAM® Tough-Case™ Bundle for Tab Active4 Pro with Power Delivery Charger



RAM-101B2-TC-SAM29C-V3FCU
 RAM® Tough-Case™ Power Delivery Bundle for Samsung Tab Active3



Mount Anything, Anywhere

SAMSUNG

rammount.com
1.800.497.7479
sales@rammount.com



Look for the highly recognizable "Double Delta" trademark, the symbol of quality and reliability



GDS® IntelliSkin®, GDS® Tech®, GDS® Technology®, GDS® Green® and GDS® Composite® are trademarks or registered trademarks of National Products Inc. The distinctive "G" shape® of the GDS® connector is a trademark of National Products Inc.

PATENTS AND TRADEMARKS
WWW.RAMMOUNT.COM/PT



RAM® double socket arms with their distinctive Hourglass Shape are recognized globally as a symbol of the reliability, quality and durability of this line of products. The Hourglass Shape is a registered trademark of National Products Inc.



The distinctive RAM® "X-Grip®" product shape is a trademark of National Products Inc.