



RAM[®]
MOUNTS

On-Road





SEEN IN THIS PHOTO:

RAM-B-166-UN14W
 RAM® Quick-Grip™ Waterproof Wireless
 Charging Suction Cup Mount

TABLE OF CONTENTS

03 NEW PRODUCTS

05 INTRO

07 HOW IT WORKS

- 07 DOUBLE BALL MOUNTS
 - 09 RAM® NO-DRILL™ VEHICLE MOUNTS
 - 11 GDS® TECH®
-

13 DEVICE HOLDERS

- 13 PHONE
 - 13 WIRELESS CHARGING
 - 15 RAM® X-GRIP®
 - 17 RAM® QUICK-GRIP™
 - 19 FORM-FIT PHONE HOLDERS
- 21 TABLETS
 - 21 RAM® X-GRIP®
 - 23 RAM® TAB-TITE™ & RAM® TAB-LOCK™
 - 25 RAM® EZ-ROLL'R™
- 27 LAPTOPS
 - 27 RAM® TOUGH-TRAY™
- 29 CAMERA ADAPTERS
- 31 GPS
 - 31 FORM-FIT HOLDERS
- 33 RADIO HOLDERS - CB-, HAM, & HANDHELD
- 35 MICS & MICROPHONE CLIPS
- 37 RAM® TOUGH-BOX™
- 39 PRINTER HOLDERS

41 VEHICLE MOUNTS

- 41 FEATURED PRODUCTS
- 43 RIGGING MAP
- 45 WINDSHIELD MOUNTING
 - 45 RAM® TWIST-LOCK™ & RAM® MIRROR-MATE™
- 47 DASHBOARD MOUNTING
 - 47 RAM® DRILL-DOWN
 - 49 FLEX ADHESIVE MOUNTS
 - 51 RAM® PORTABLE FRICTION DASHBOARD BASE & RAM® ADHESIVE DASHBOARD BASE
 - 53 MAGNETIC MOUNTING
- 55 CUP HOLDER MOUNTING
 - 55 RAM® STUBBY™ & RAM-A-CAN™ II
- 57 SEAT MOUNTING
 - 57 RAM® TOUGH-WEDGE™
- 59 RAM® TOUGH-TRACK™
 - 61 RAM® TOUGH-TRACK™ FOR JEEP JLS & GLADIATORS
 - 62 RAM® HAND-TRACK™
 - 62 TOP-LOADING COMPOSITE
 - 63 RAM® TRACK MOUNTS
- 65 FLOOR MOUNTING
 - 65 RAM® NO-DRILL™
 - 67 RAM® TELE-POLE

69 ENTERPRISE SOLUTIONS

69 FEATURED PRODUCTS

71 ELD MOUNTING

- 71 SAMSUNG GALAXY TAB A 8.4 & TAB A 8.0 (2019)
- 72 SAMSUNG TAB ACTIVE3/2 & TAB ACTIVE PRO
- 73 RAM® TOUGH-CASE™
- 75 RAM® TOUGH-CASE™ HOLDER

77 INTELLISKIN® & INTELLISKIN® NEXT GEN

79 GDS® ERGO™

- 79 ACCESSORIES THAT GET THE JOB DONE

81 GDS® VEHICLE DOCKS™

- 83 FUTURE PROOF
- 85 GDS® TOUGH-DOCK™ & GDS® COOL-DOCK™

87 GDS® VIEW™

- 87 EXPAND THE CAPABILITIES OF YOUR WORKSTATION

89 GDS® KEYBOARD™

- 89 RUGGED AND DURABLE KEYBOARD SOLUTION

91 GDS® AUDIO™

- 91 AMPLIFIED AUDIO ON THE GO

93 GDS® TOUGH-HUB™ EXPAND YOUR WORKFLOW

94 GDS® ECOSYSTEM™

95 GDS® CHARGE™

- 95 CHARGERS FOR ANY SITUATION

97 RAM® SKIN™

99 FORM-FIT HOLDERS

101 SAMSUNG XCOVER PRO

103 SAMSUNG DEX IN-VEHICLE

105 ZEBRA

- 107 SCANNER SOLUTIONS

108 PANASONIC AND HONEYWELL

109 SONIM

- 111 SONIM BUNDLE FOR SONIM XP5S & SONIM XP8

113 OTTERBOX UNIVERSE SOLUTIONS

115 MOTORCYCLE MOUNTS

115 FEATURED PRODUCTS

117 RIGGING MAP FOR MOTORCYCLES

119 HANDLEBAR MOUNTING

- 119 U-BOLT HANDLEBAR BASE
- 121 RAM® TOUGH-CLAW™
- 123 RAM® TORQUE™
- 124 FORK STEM

125 SURFACE MOUNTING

- 125 BRAKE/CLUTCH RESERVOIR BASE
- 126 RESERVOIR COVER BASE
- 127 HANDLEBAR CLAMP BASE
- 128 BOLT HEAD ADAPTER BASES
- 129 GAS TANK BASE
- 130 THREADED BALL ADAPTERS
- 131 RAM® TOUGH-BALL™ FOR HARLEY DAVIDSON
- 132 RAM® TWIST AND TILT™

133 ACCESSORIES & MORE

133 ARMS

135 ARM ACCESSORIES

137 DRINK HOLDER MOUNTS

139 BICYCLE MOUNTS

139 RAM® EZ-STRAP™ & EZ-ON/OFF™

141 RAM® TOUGH-CLAW™ LOW PROFILE

143 RV/MOTORHOME

145 PRODUCT CHARTS

SEEN IN THIS PHOTO:

RAM-TC-SAM29CU

RAM® Tough-Case™ with
USB Type-C for Samsung Tab
Active3 and Tab Active2



NEW PRODUCTS



**RAM-GDS-SKIN-AP32-NG,
RAM-GDS-DOCKLF-AP32CU**
Apple iPad Air 4 & Pro 11" - GDS®
Tough-Dock™ & Cool-Dock™



RAM-HOL-ZE14U
RAM® Form-Fit Powered Holder
for Zebra TC21 & TC26



RAM-TC-SAM29CU
RAM® Tough-Case™ with USB Type-C
for Samsung Tab Active3
and Tab Active2



RAM-GDS-CHARGE-V3FCA2U
Hardwire Chargers with Power Delivery
and Dual USB Data



**RAM-HOL-AP33U
RAM-HOL-AP34U
RAM-HOL-AP35U**
Apple iPhone 12 Series -
Form-Fit Holders



**RAM-GDS-SKIN-SAM75-NG
RAM-GDS-DOCKLF-SAM75U**
Samsung Tab A7 10.4 - GDS®
Tough-Dock™ & Cool-Dock™



RAM-TC-SAM50U
RAM® Tough-Case™ for Samsung
Tab A 10.1, Tab A7 10.4 &
Tab S6 LITE 10.4



RAM-TC-SAM67-387U
RAM® Tough-Case™ for
Samsung
Tab A 8.0 (2018) SM-T387



RAM-TC-SAM67-307U
RAM® Tough-Case™ for
Samsung
Tab A 8.4 SM-T307



RAM-TC-SAM67-290U
RAM® Tough-Case™ for
Samsung
Tab A 8.0 (2019) SM-T290



RAM-HOL-TABL-SAM29U
RAM® Tab-Lock™ Holder for
Samsung Tab Active3 and
Tab Active2



RAM-SPEAK-A02
GDS® Audio™ Amplified Speaker with
PTT Breakout Feature



RAM-SKIN-SAM73
RAM® Skin™ for
Samsung
Tab Active3



**RAM-GDS-SKIN-SAM74-NG,
RAM-GDS-DOCKLF-SAM62U**
IntelliSkin® Next Gen for Samsung
Tab Active3,
Samsung Tab Active3 & Tab Active2 -
GDS® Tough-Dock™ & Cool-Dock™



RAM-TC-SAM54U
RAM® Tough-Case™ for Samsung
Tab Active Pro - Type A Male USB

SEEN IN THIS PHOTO:

RAM-GDS-SKIN-SAM62-NG

IntelliSkin® Next Gen for Samsung Tab Active2

RAM-GDS-DOCKL-V9-OMT1U

GDS® Type-C Vehicle Dock for IntelliSkin® Next Gen Tablets

RAM-101U-B

RAM® Universal Double Ball Mount with Two Round Plates



ABOUT RAM® MOUNTS

RAM® Mounts manufactures rugged and versatile mounting systems for phones, tablets, and other mobile devices that can be attached nearly anywhere. Unlike other mounts on the market, RAM® allows you to secure devices where you need them most. The unique design of the RAM® Mounts system provides quick installation, adjustability, strength, vibration damping, and durability—all at a low cost. Backed by a lifetime warranty, RAM® uses powder-coated, marine-grade aluminum with lightweight and high-strength composites, stainless steel hardware, and rubber balls.

THE RAM® DIFFERENCE



PREMIUM DESIGN

The rubber ball and socket design of our mounting systems offers a secure hold, with near-infinite adjustability and vibration damping for the most demanding environments. With thousands of components trusted by users around the world, we've been able to design and develop mounting solutions that consumers and companies previously only dreamed were possible.

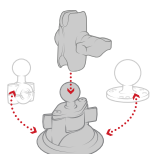

CUSTOMIZABLE

Take your phone mount from your truck to your boat, or mix and match components to create your ideal mount. Because of the modularity of the RAM® system, you can customize your solution to fit your specific needs in almost any application.

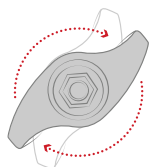

QUALITY MATERIALS

A premium design deserves the highest quality materials available, from rubber and stainless steel to high-strength composites and marine-grade aluminum. Our facilities— including powder coating, die casting, rubber injection molding, and shock and vibration testing—help us deliver on this promise to bring you inventive mounting solutions.

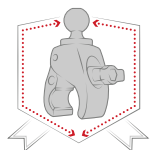

LIFETIME WARRANTY

It's simple. Our reputation as the leader of premier mounting systems means if we build it, then we guarantee it. We're confident in the quality of our products, and with our warranty, you can be too.

NATIONAL PRODUCTS INC. (NPI)

Introduced in 1995, National Products Inc. (NPI) quickly became the leading manufacturer of rugged and versatile mounting solutions. RAM® Mounts has grown to offer approximately 5,000 modular components—the most innovative product line of its kind for nearly any application and device, including phones, tablets, GPS systems, laptops, marine electronics, printers, radios, and much more.

In addition to RAM® Mounts, NPI is also the creator of award-winning IntelliSkin® sleeves and GDS® Technology™ products. IntelliSkin® sleeves ruggedize a wide range of consumer phones and tablets, while the GDS® Ecosystem™ provides users the ability to securely charge, dock, and sync devices in the most demanding environments.

NPI is proudly located in Seattle, Washington in the same neighborhood where the company was started.

PARTNER WITH RAM® MOUNTS

Here at RAM® Mounts, we believe that unfathomable things are possible with ingenuity. With a portfolio of more than 5,000 SKUs paired with innovative engineers and in-house product experts, we have the tools and expertise needed to create solutions that you didn't know were possible. We have the ability to solve your mounting challenges quickly, efficiently, and cost effectively.

HOW IT WORKS

DOUBLE BALL MOUNTS

Choose from a selection of holders, socket arms and ball bases to build a custom mount for your specific needs. Additional bases may be chosen so that your mount can support multiple devices, or can be transferred to alternate mounting locations.

1

CHOOSE A HOLDER

RAM® offers a wide selection of holders for your specific device.

2

CHOOSE AN ARM

Select an arm based on your desired length and placement.

3

CHOOSE A BASE

Select from a variety of bases to help secure your device where you need it.

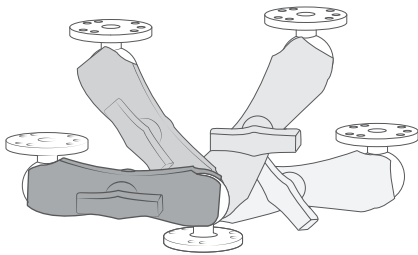

Double ball and socket technology allows for near-infinite adjustability of your RAM® mounting system

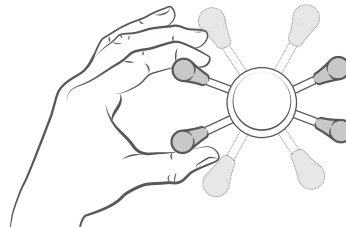

Highly adjustable



Vibration damping

GENERAL RULE

B Size ball & socket mounts are recommended for handheld devices, phones, GPS, and small tablets

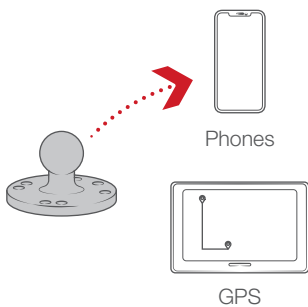

C size ball & socket mounts are recommended for larger, heavy duty tablets, and are used in the RAM® No-Drill™ laptop mounts

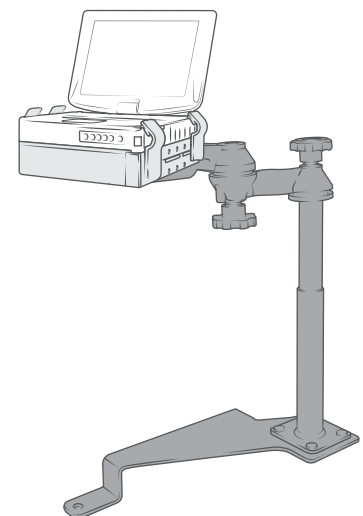
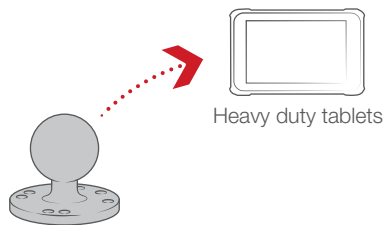

RAM® No-Drill™ laptop mounts

1 HOLDERS



BEST SELLER

RAM-HOL-UN10BU
RAM® X-Grip® for Large Phones

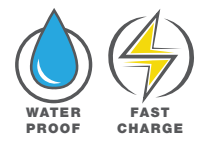

RAM-HOL-UN12WB
Wireless RAM® Tough-Charge™ with X-Grip® Technology



RAM-B-202-GA76U
RAM® Spine Clip Holder with Ball for Garmin Handheld Devices



RAM-B-202U-GOP1
RAM® Action Camera Universal Ball Adapter

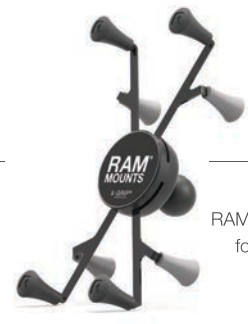

RAM-HOL-UN8BU
RAM® X-Grip® Universal Holder for 7"-8" Tablets with Ball



RAM-HOL-PD4-238AU
RAM® Quick-Grip™ XL Holder

2 SOCKET ARMS



RAM-B-201U-A
2.42" Short Socket Arm



RAM-B-201U
3.73" Medium Socket Arm



RAM-B-201U-C
6" Long Socket Arm

3 BASES



RAP-B-378U
RAM® Flex Adhesive Ball Base



RAM-B-202U
RAM® Round Drill-Down Base



RAM-B-238U
RAM® Diamond Drill-Down Base



BEST SELLER

RAM-B-224-1U
RAM® Twist-Lock™ Suction Cup Base with Ball



RAP-B-400U
RAM® Tough-Claw™ Small Clamp Base with Ball



RAP-B-354U-TRA1
RAM® Track Ball™ with T-Bolt Attachment

MORE COMPONENTS AVAILABLE AT
RAMMOUNT.COM/COMPONENTS

HOW IT WORKS

RAM® NO-DRILL™ VEHICLE MOUNTS

Vehicle mounting solutions from RAM® Mounts are the top choice for securing laptops, tablets, add-ons and more. Our No-Drill™ vehicle bases are easy to install using only the existing seat bolts to your specific vehicle. We have many vehicle bases to choose from that fit seamlessly in your specific car, truck, van or fleet vehicle—universal options for all other vehicles. These mounting solutions have become a popular choice for creating a mobile workstation or a hub for mounting multiple devices.

1

CHOOSE A TRAY/HOLDER

Select a tray/holder based on your device.

2

CHOOSE A RAM® TELE-POLE™ & SWING ARM

Select a RAM® Tele-Pole™ and swing arm that provides the correct amount of height and adjustability.

3

CHOOSE A BASE

Select a base that meets your installation and removal needs and fits your vehicle.

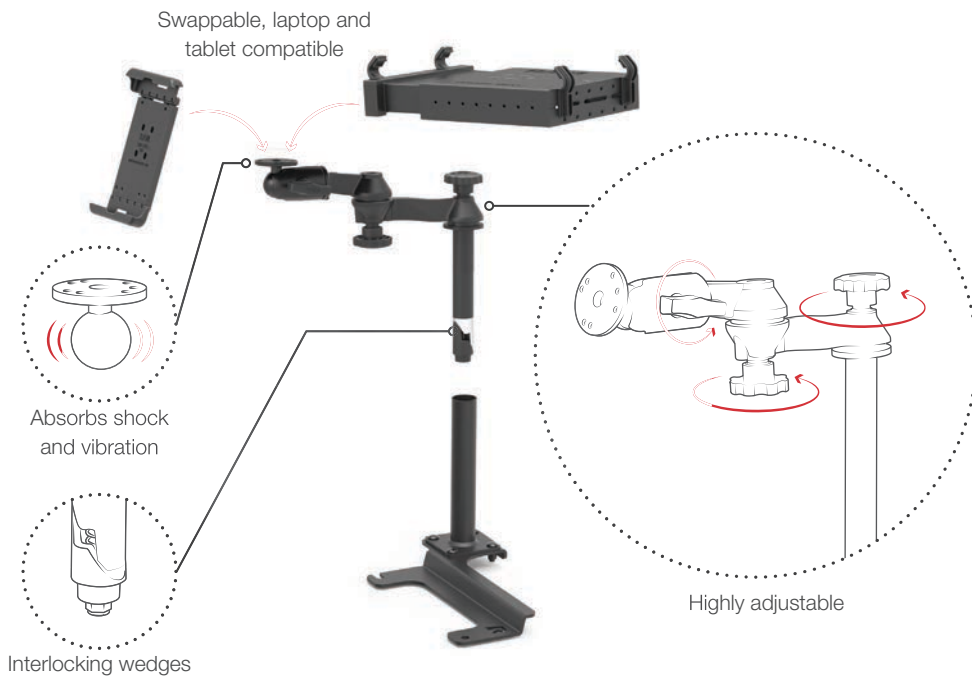



1 TRAY/HOLDERS



RAM-234-3
RAM® Tough-Tray™ Spring Loaded Laptop Holder



RAM-234-3FL
RAM® Tough-Tray™ Spring Loaded Laptop Holder with Flat Retaining Arms



RAM-HOL-TABL20U
RAM® Tab-Lock™ Holder for 9"-10.5" Tablets with Heavy Duty Cases



RAM-HOL-UN9U
RAM® X-Grip® Universal Holder for 9"-10" Tablets

2 RAM® TELE-POLE™ & SWING ARMS



RAM-VP-SW1-89
RAM® Tele-Pole™ with 8" & 9" Poles, Double Swing Arms & Round Plate



RAM-VP-SW1-129
RAM® Tele-Pole™ with 8" & 9" Poles, Double Swing Arms & Round Plate



RAM-VP-SW1-1218
RAM® Tele-Pole™ with 12" & 18" Poles, Double Swing Arms & Round Plate



RAM-VP-SW2F-89
RAM® Tele-Pole™ with 8" & 9" Poles and Double Ball Mount

3 BASES



RAM-VB-202-A
RAM® No-Drill™ Vehicle Base for 2020 Ford Explorer



RAM-VB-168
RAM® No-Drill™ Universal Vehicle Base for Heavy Duty Trucks

BEST SELLER



RAM-VB-195
RAM® No-Drill™ Vehicle Base for '17-20 Ford F-Series + More

+ SEE PAGE 145 FOR **VEHICLE COMPATIBILITY**

HOW IT WORKS

GDS® TECH™

The GDS® platform provides protection, charging, and data sync capabilities across a wide range of phones and tablets, making it a perfect solution for fleet transportation. With GDS® Compatible™ IntelliSkin® protective sleeves, GDS® Docks™, and GDS® Ecosystem™ accessories, simplify the process of scaling and upgrading devices while taking advantage of a standardized charging and data transfer ecosystem.

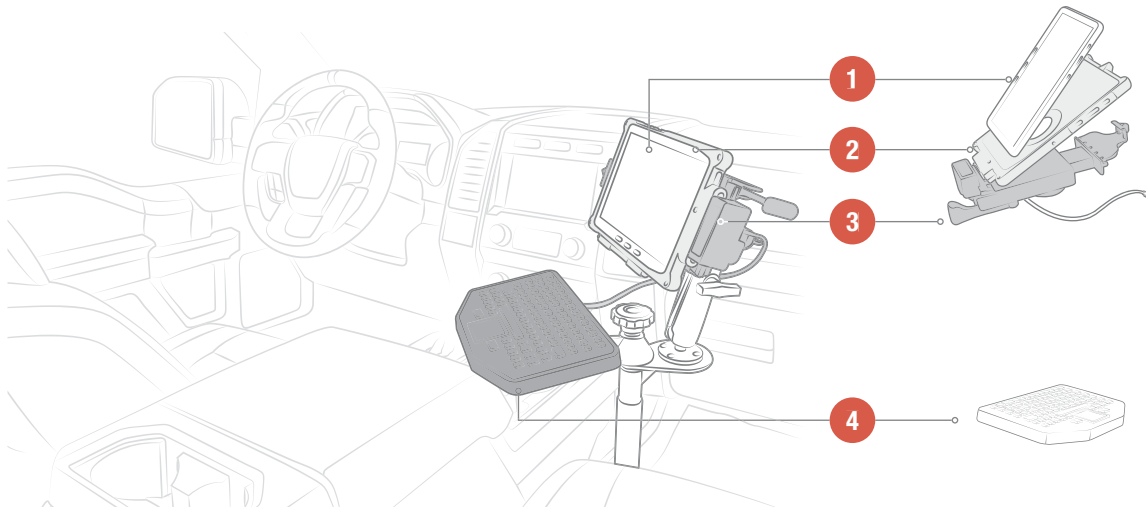

1 DEVICE



The GDS® Ecosystem™ invites most Samsung Galaxy tablets and Apple iPads including the new Galaxy Tab Active3, Tab Active Pro, iPad Pro 12.9 and iPad 8th Gen. To discover all supported devices, visit gdstech.com.

2 INTELLISKIN®



- Drop protection
- Pogo pin technology
- Universal docking
- Ergonomic accessories

INTELLISKIN® NEXT GEN



- External USB Type-C connector
- Hard plastic internal shell
- Precise dock alignment

3 GDS® VEHICLE DOCK™



- RAM® Mounts compatible
- Future proof
- High speed power
- USB peripheral options

GDS® TOUGH-DOCK™ & COOL-DOCK™



- Custom form-fit
- Built-In fan
- Integrated cavity for GDS® Hand-Stand™
- Locking & non-locking

4 PERIPHERALS



GDS® CHARGE™



GDS® TOUGH-HUB™



GDS® KEYBOARD™



GDS® VIEW™

1 DEVICE



SAMSUNG

2 INTELLISKIN®



RAM-GDS-SKIN-SAM54-NG
IntelliSkin® Next Gen for Samsung Tab Active Pro



RAM-GDS-SKIN-SAM67-NG
IntelliSkin® Next Gen for Samsung Tab A 8.4 SM-T307



RAM-GDS-SKIN-SAM74-NG
IntelliSkin® Next Gen for Samsung Tab Active3



RAM-GDS-SKIN-SAM59
IntelliSkin® for Samsung Galaxy XCover Pro



RAM-GDS-SKIN-SAM71
IntelliSkin® for Samsung Galaxy S20 Ultra 5G



RAM-GDS-SKIN-SAM69
IntelliSkin® for Samsung Galaxy S20 5G

3 GDS® DOCK™



RAM-GDS-DOCK-D2CU
GDS® Desktop Dock with USB Type-C for IntelliSkin® Products



RAM-GDS-DOCK-V1CU
GDS® Vehicle Phone Dock with USB Type-C for IntelliSkin® Products



RAM-GDS-DOCKL-V9-OMT1U
GDS® Type-C Vehicle Dock for IntelliSkin® Next Gen Tablets



RAM-GDS-DOCK-6G1P-NGU
GDS® 6-Port Desktop Charger for IntelliSkin® Next Gen



RAM-GDS-DOCKLF-SAM67U
Locking GDS® Cool-Dock™ for Samsung Tab A 8.4 SM-T307

SEEN IN THIS PHOTO:

RAM-B-166-UN14W
RAM® Quick-Grip™
Waterproof Wireless Charging
Suction Cup Mount



**BEST
SELLER**

RAM-B-166-UN14W
RAM® Quick-Grip™ Waterproof Wireless Charging
Suction Cup Mount

DEVICE HOLDERS

PHONE WIRELESS CHARGING

The RAM® Tough-Charge™ with RAM® X-Grip® Technology and RAM® Quick-Grip™ Wireless are the world's first patented, universal waterproof wireless charging cradles for smartphones. Designed with spring-loaded technology, utilize the best parts of both the RAM® X-Grip® and RAM® Quick-Grip™ phone holders while pairing any smartphone with wireless charging capabilities. For added security and peace of mind, a safety tether is included that's recommended for outdoor applications. Available in a variety of mounting kits, ensure wireless charging capabilities across a wide range of vehicles.

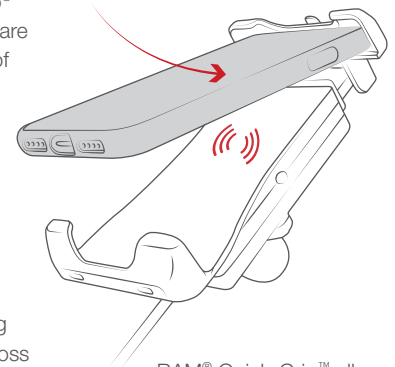

RAM® Quick-Grip™ allows for one-handed docking

FEATURES



Includes ON/OFF switch when wireless charger is not in use

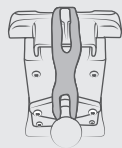

Includes safety tether for extra peace of mind



Qi Compatible charging up to 10W



Sealed and safe for open cockpit environment

SEEN IN THIS PHOTO:

RAM-B-166-UN12W
 RAM® Tough-Charge™
 Waterproof Wireless
 Charging Suction Cup Mount



RAM-B-166-UN12W
 RAM® Tough-Charge™ Waterproof Wireless
 Charging Suction Cup Mount

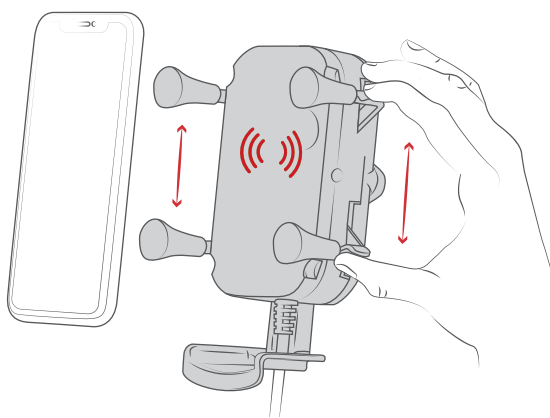

Spring-loaded 'X' design with rubber caps provides a secure fit

FEATURES



Includes safety tether for extra peace of mind

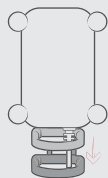

Includes adjustable support leg



Qi Compatible charging up to 10W



Sealed and safe for open cockpit environment

[CLICK HERE TO VIEW PHONE COMPATIBILITY](#)

SEEN IN THIS PHOTO:

RAM-B-166-UN7U

RAM® X-Grip® Phone Mount with RAM®
Twist-Lock™ Suction Cup

DID YOU KNOW

RAM® Mounts focuses on universal solutions. Between the standard and large sizes, the RAM® X-Grip® for phones can hold pretty much any phone with or without a case.



SEEN IN THIS PHOTO:

RAM-B-149Z-UN10U

RAM® X-Grip® Large Phone Mount with
 Handlebar U-Bolt Base Waterproof
Wireless Charging Suction Cup Mount



RAM-HOL-UN7BU
 Small Phone Holder



**BEST
 SELLER**

RAM-HOL-UN10BU
 Large Phone Holder



RAM-HOL-UN12WB
 Wireless RAM®
 Tough-Charge™

DEVICE HOLDERS CONTINUED

**PHONE
 RAM® X-Grip®**

The RAM® X-Grip® is the most durable universal phone holder on the market. The spring-loaded arms expand and contract to provide a perfect fit for your phone with or without a case. Available for phones of all sizes, the RAM® X-Grip® cradle secures your device while

keeping it completely functional and accessible. No matter what mounting base you pair the RAM® X-Grip® with, the RAM® ball and socket technology allows for near-infinite adjustability and extends the life of your phone with vibration damping capabilities.

Spring-loaded 'X' design with rubber caps provides a secure fit

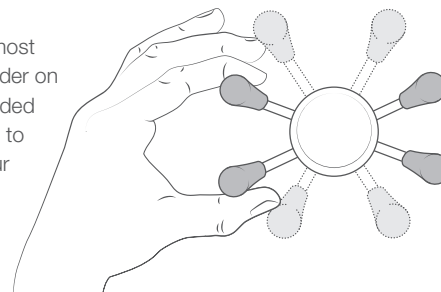

FEATURES

Leaves buttons and ports exposed and accessible

Includes safety tether for extra peace of mind

Supports phone with and without a case

[+ CLICK HERE TO VIEW PHONE COMPATIBILITY](#)

SEEN IN THIS PHOTO:

RAM-HOL-PD3-238AU

RAM® Quick-Grip™ Universal
Phone Holder with Ball

RAM-B-201U-C

RAM® Double Socket Arm

RAP-B-400U

RAM® Tough-Claw™ Small
Clamp Base with Ball



SEEN IN THIS PHOTO:

RAM-B-166-PD3
 RAM® Quick-Grip™ Phone Mount with RAM® Twist-Lock™ Suction Cup Base



BEST SELLER

RAM-HOL-PD4-238AU
 Large Phone Holder



RAM-HOL-PD3-238AU
 Small Phone Holder



FAST CHARGE **WATER PROOF**

RAM-HOL-UN14WB
 Wireless RAM® Quick-Grip™

DEVICE HOLDERS CONTINUED

PHONE RAM® QUICK-GRIP™

Capable of holding a broad range of electronics, the spring-loaded grips provide a secure fit for your phone with or without a case. Take advantage of efficient one-handed placement and removal of your device no matter if the device is in portrait, or landscape.

The adjustable side support arms add extra security and can shift to fit the width of your device perfectly. Available for standard size phones and larger models.

Spring-loaded top grip keeps device in place

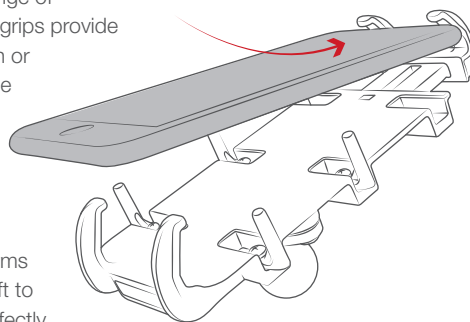

FEATURES

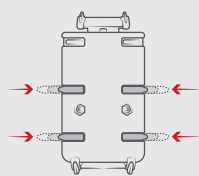

Adjustable side supports for wider devices

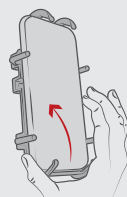

One-handed docking and removal

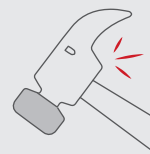

Made of high-strength composites for durability and reliability in the most demanding environments

+ SEE PAGE 151 FOR RAM QUICK-GRIP COMPATIBILITY



SEEN IN THIS PHOTO:

RAM-HOL-AP25U

RAM® Form-Fit Cradle for
Apple iPhone XS

DEVICE HOLDERS CONTINUED

PHONE FORM-FIT PHONE HOLDERS

These high-strength composite, form-fit cradles were designed specifically for the Apple, Samsung and Sonim devices. Allowing for one-handed docking and removal, all buttons, cameras, ports, and speakers are left exposed. With the two-hole AMPS pattern on the back of each cradle, attach to a RAM® diamond ball base and additional RAM® components.

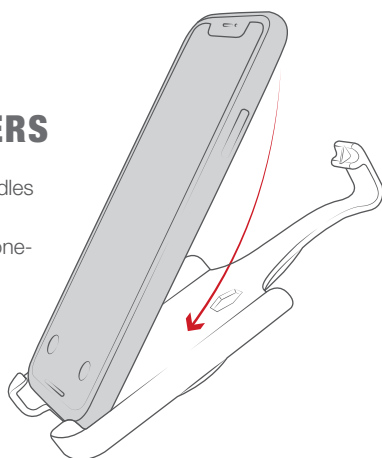

Designed for one-handed docking and removal of device providing a perfect fit without a case



AM-HOL-AP35U
RAM® Form-Fit Cradle for Apple iPhone 12 Pro Max



RAM-HOL-AP34U
RAM® Form-Fit Cradle for Apple iPhone 12 mini



RAM-HOL-AP33U
RAM® Form-Fit Cradle for Apple iPhone 12 & 12 Pro



RAM-HOL-SAM72PU
Powered RAM® EZ-Roll'r™ for Samsung Galaxy XCover FieldPro



RAM-HOL-SAM9PU
Powered RAM® EZ-Roll'r™



RAM-B-166-AP18U
RAM® Twist-Lock™ Suction Cup Mount for Apple iPhone 6 & 7



RAM-B-166-AP19U
RAM® Twist-Lock™ Suction Cup Mount for Apple iPhone 6 & 7

FEATURES

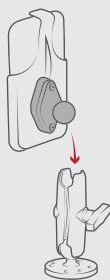

Compatible with B and C size RAM® diamond ball bases for attaching a double socket arm



Made of high-strength composites for durability and reliability in the most demanding environments



Low cost, Low profile, Highly durable



[CLICK HERE TO VIEW ALL FORM-FIT HOLDERS](#)



SEEN IN THIS PHOTO:

RAM-HOL-UN9U
RAM® X-Grip® Universal
Holder for 9"-10" Tablets



**BEST
SELLER**

RAM-HOL-UN9U

RAM® X-Grip® Universal Holder
for 9"-10" Tablets

DEVICE HOLDERS CONTINUED

TABLETS

RAM® X-GRIP®

Using a tablet for in-vehicle navigation and mobile work is on the rise. The RAM® X-Grip® for Tablets holds all the benefits and design features of the standard X-Grip® with added arm support for a variety of different size tablets with, or without a case. Additional grip handles provide side support for portrait, or landscape orientation, and are completely removable. Protect your investment with the highly rugged X-Grip® and be sure these holders stand the test of time in the harshest environments.

Additional grip handles for convenient insertion and removal

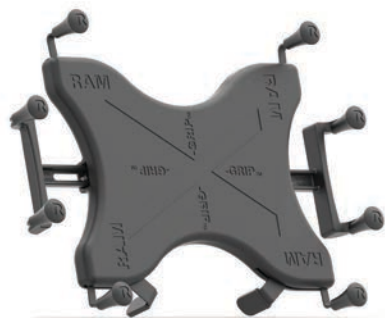
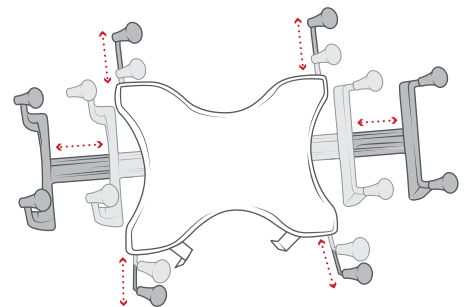

RAM-HOL-UN11U
For 11"-12" Tablets

FEATURES

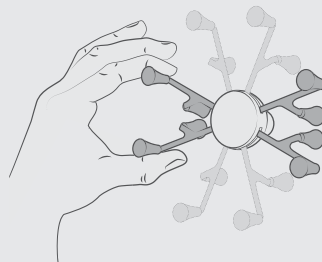

Highly adjustable to support tablets in portrait and landscape mode



Fits all tablets
7" - 12" with or
without a case

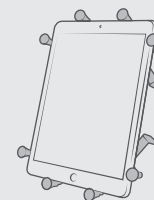

Steel spring-loaded
arms keep
tablets secure



SEEN IN THIS PHOTO:

RAP-B-299-4-UN8U
 RAM® X-Grip® for 7"-8"
 Tablets with RAM® Stubby™
 Cup Holder Base

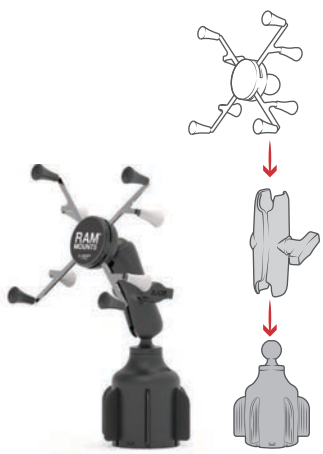

RAP-B-299-4-UN8U

RAM® X-Grip® for 7"-8" Tablets with
 RAM® Stubby™ Cup Holder Base



RAM-HOL-UN8BCU

RAM® X-Grip® Universal Holder
 for 7"-8" Tablets with Ball



RAM-HOL-UN8BU

RAM® X-Grip® Universal Holder for
 7"-8" Tablets with Ball



RAP-B-407-UN8U

RAM® X-Grip® Mount with RAM®
 Tough-Wedge™ for 7"-8" Tablets



RAM-VB-195-SW2 & RAM-HOL-UN9U

RAM® No-Drill™ Mount for '17-21
 Ford F-250 - F-550 + More &
 RAM® X-Grip® Universal Holder for 9"-10" Tablets

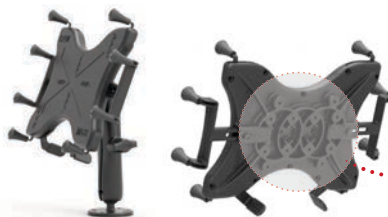

RAM-B-101-C-UN9U

RAM® X-Grip® Drill-Down Double Ball Mount for 9"-10" Tablets

Multiple AMPS hole patterns and
 the 75x75mm VESA pattern

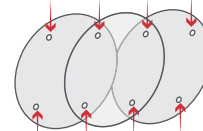

[+ CLICK HERE TO VIEW ALL TABLET COMPATIBILITY](#)



RAM-HOL-TAB29U

RAM® Tab-Tite™ Spring Loaded Holder for 8" Tablets with Cases

DEVICE HOLDERS CONTINUED

**TABLETS
RAM® TAB-TITE™ &
RAM® TAB-LOCK™**

Get the most out of your tablet with the RAM® Tab-Tite™ spring-loaded, quick release holder. With interchangeable end cups, you can fit the holder to your tablet for a near custom fit. The spring-loaded design makes it easy to insert and remove your tablet while keeping it secure.

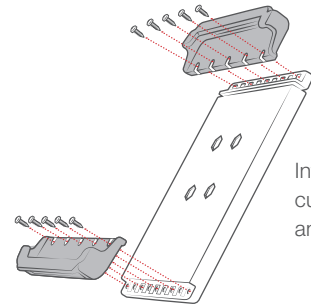

Interchangeable cups support any tablet



RAM-HOL-TAB24-CUPSU

RAM® Tab-Tite™ End Cups for 8" Tablets

**BEST
SELLER**



RAM-HOL-TAB20U

RAM® Tab-Tite™ Holder for 9" Tablets with Heavy Duty Cases



RAM-HOL-TABL24U

RAM® Tab-Lock™ Spring Loaded Holder for 8" Tablets



RAM-HOL-TAB-RISER2U

1" Risers for RAM® Tab-Tite™ and RAM® Tab-Lock™ Holders



RAM-B-407-201-C-TAB3U

RAM® Tab-Tite™ with RAM® Tough-Wedge™ Mount for 10" Tablets



RAM-B-138-TAB4-225BU

RAM® Tab-Tite™ Drill-Down Mount with Backing Plate for Small Tablets



RAM-B-299-3-TAB30U

RAM® Tab-Tite™ Cup Holder Mount for Samsung Galaxy Tab S2 8.0 + More



RAM-138-TAB17U
RAM® Tab-Tite™ Large Tablet Holder with Flat Surface Mount

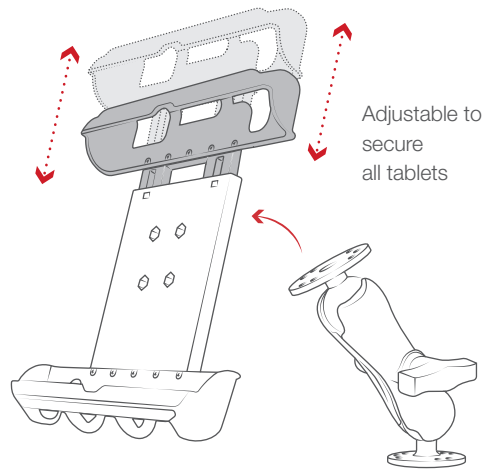

FEATURES

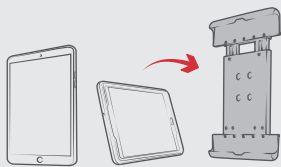

Supports tablets in portrait and landscape mode



Made of high-strength composites for durability and reliability in the most demanding environments

Non-locking and locking options available

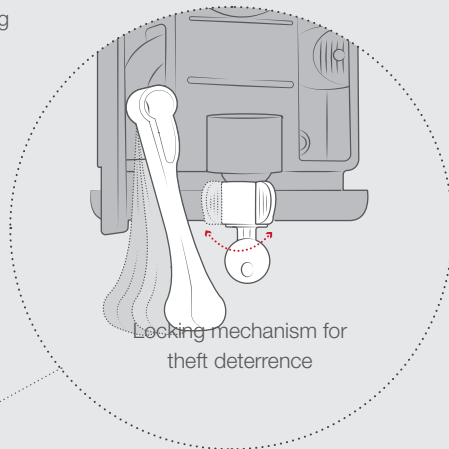
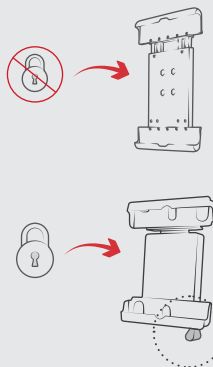

+ SEE PAGE 149 FOR TABLET COMPATIBILITY



SEEN IN THIS PHOTO:

RAM-HOL-AP24U
 RAM® EZ-Roll'r™
 Cradle for the Apple
 iPad Pro 12.9" 3rd Gen



RAM-HOL-AP23U
 RAM® EZ-Roll'r™ Cradle for the Apple
 iPad Pro 11"

DEVICE HOLDERS CONTINUED

TABLETS
RAM® EZ-ROLL'R™

These form-fit holders are designed to fit your device perfectly for a low-profile mounting solution. The patented roller design allows for easy docking and removal of the tablet without fumbling around. Samsung devices take advantage of integrated pogo pins designed to connect to the device's pogo pads for continuous charging capabilities through the dock's built-in USB cables.

Patented roller design protects device and makes the insertion & removal of the tablet easy

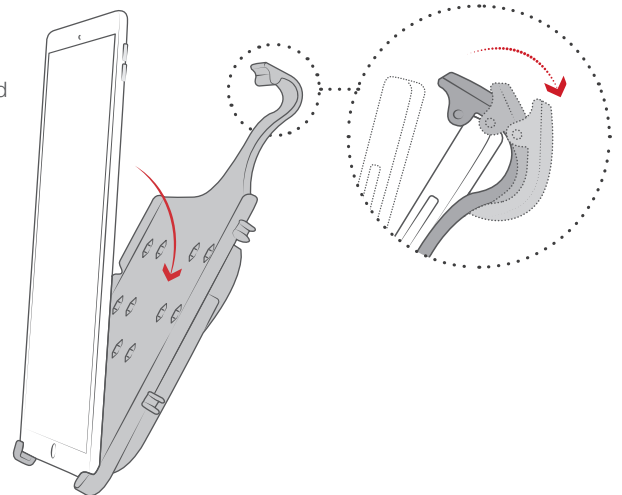

FEATURES

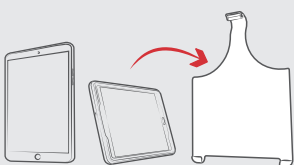

Supports tablets in portrait and landscape mode



Made of high-strength composites for durability and reliability in the most demanding environments





Integrated Apple Pencil holder for select models

SEEN IN THIS PHOTO:

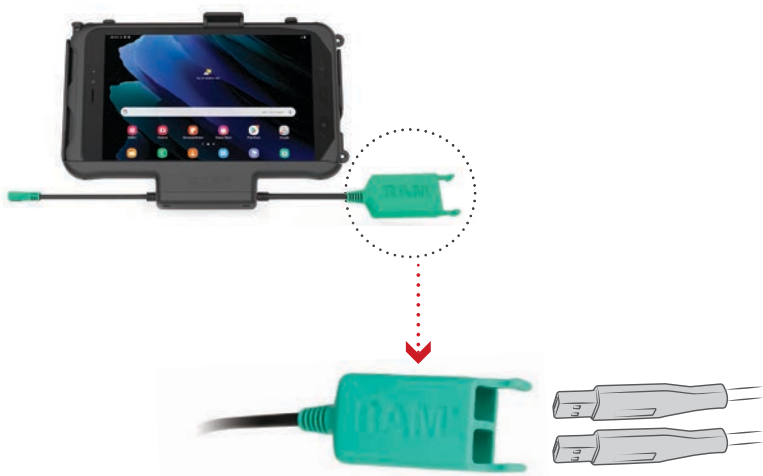
RAM-HOL-SAM60PD2U
 RAM® EZ Roll'r™ Dual
 USB Cradle for
 Samsung Tab Active3
 and Tab Active2

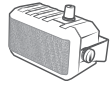
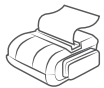

Connect up to any two USB Type A peripherals directly to your Tab Active2, Tab Active3 and Tab Active Pro

-  **EXTERNAL HARD DRIVE**
-  **KEYBOARD**
-  **SCANNER GUN**
-  **SPEAKER**
-  **PRINTER**

RAM-HOL-SAM60PD2U

RAM® Power + Dual USB Dock for Samsung Tab Active3 and Tab Active2



BEST SELLER

RAM-HOL-AP20U
 For iPad mini 4 & 5



RAM-HOL-AP31U
 For Apple iPad 7th & 8th Gen



SEEN IN THIS PHOTO:

RAM-VB-193-SW1
RAM® No-Drill™
Laptop Mount

RAM-234K1-4U
Universal Laptop
RAM® Tough-Tray™
Flat Clamping Arm Kit

DEVICE HOLDERS CONTINUED

LAPTOPS
RAM® TOUGH-TRAY™

The RAM® Tough-Tray™ is a spring-loaded expandable tray that can accommodate up to 17.5" Laptops. Four-sided clamping arms with rubber grips can be moved both vertically and allowing for a custom fit for varying laptops and the freedom of not ports or drives.

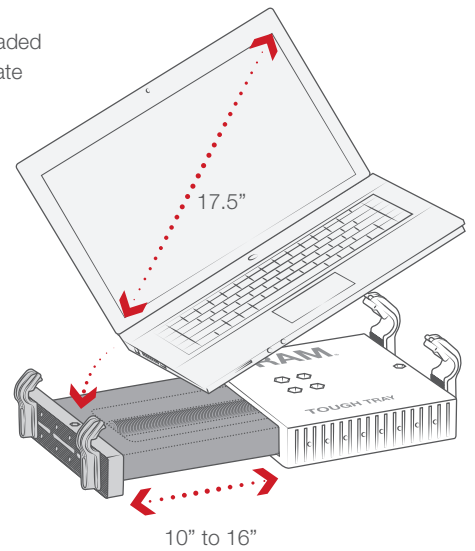

Spring-loaded universal laptop tray accommodates up to 17.5" laptops



RAM-234-3

RAM® Tough-Tray™ Spring Loaded Laptop Holder



RAM-234-3FL

RAM® Tough-Tray™ Spring Loaded Laptop Holder with Flat Retaining Arms

BEST SELLER



RAM-VB-195-SW1

RAM® No-Drill™ Laptop Mount for '17-20 Ford F-Series + More



RAM-VB-178A-SW1

RAM® No-Drill™ Laptop Mount for '12-21 RAM 2500-5500 + More



RAM-VB-203-SW1

RAM® No-Drill™ Laptop Mount for '19-21 Chevy Silverado + More



RAM-VB-193-SW1

RAM® No-Drill™ Laptop Mount for '14-19 Chevrolet Silverado + More

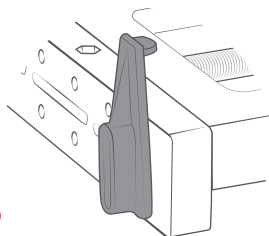
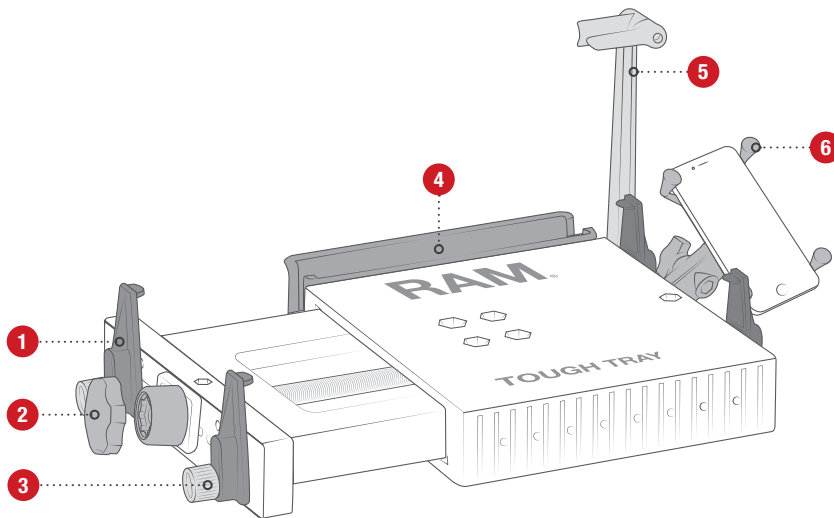

1

RAM-234K1-4U

RAM® Tough-Tray™ Flat Clamping Arm Kit

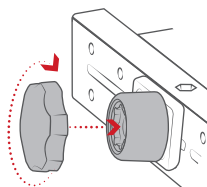

2

RAM-234-SKNMU

RAM® Secure-N-Motion™ w/
RAM® Pin-Lock™ Security Kit

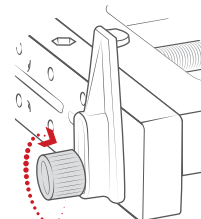

3

RAM-234-AK1U

RAM® Adjustable Knob Kit for
RAM® Tough-Tray™

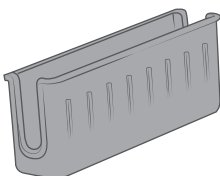

4

RAM-234-5U

RAM® Power Caddy™ Accessory Holder for
RAM® Tough-Tray™

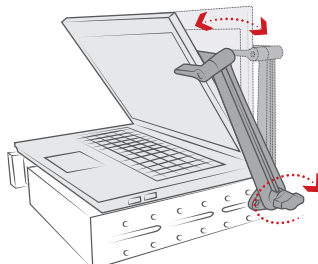

5

RAM-234-S2U

RAM® Adjustable Laptop Screen
Support Arm

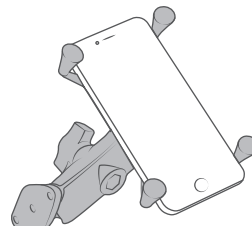

6

RAM-B-102-UN10U

RAM® X-Grip® Large Phone Mount
with Diamond Base

FEATURES

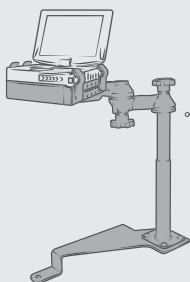

Ball & socket mounting allows angled mounting of laptop for wrist comfort

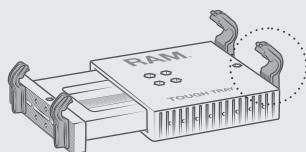

Adjustable side arms keep ports and drives exposed



SEE PAGE 145 FOR ALL VEHICLE COMPATIBILITY



SEEN IN THIS PHOTO:

RAP-B-202U-GOP1
 RAM® Action Camera
 Universal Ball Adapter

RAP-B-202U-GOP2
 RAM® Ball Adapter for
 GoPro® Mounting Bases



RAP-B-202U-GOP1
 RAM® Action Camera
 Universal Ball Adapter

DEVICE HOLDERS CONTINUED

CAMERA ADAPTERS

Capture the best photos and video possible with the help of RAM® Mounts camera ball adapters, allowing for the perfect angle and a secure hold. Constructed with the highest quality materials, the RAM® ball design dampens shock and vibration so you always get the shot.

The GoPro® base adapter is specifically designed for GoPro® action cameras, this base adapter replaces the factory mount. Combine it with a RAM® Mounts arm and a two-pronged universal action camera adapter to allow for easily adjustable 360 degree rotation of your camera.

Rubber ball dampens shock and vibration

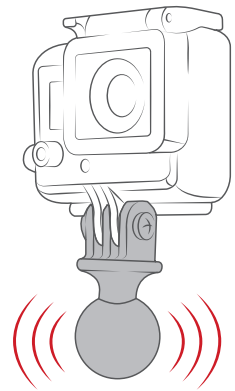

FEATURES



RAP-B-379U-252025
 RAM® Tough-Ball™ with
 1/4"-20 x .25"
 Threaded Stud

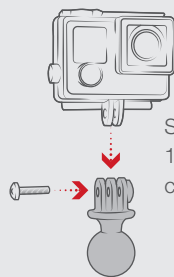

Supports all cameras with
 1/4"-20 adapter, and action
 camera hinge adapter

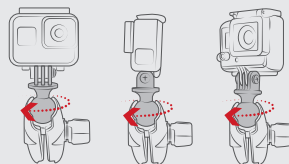

Adjustable position of
 camera with the turn of
 a single knob

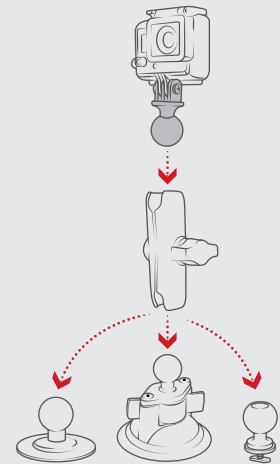

Modular components allows user
 to mount camera anywhere

SEEN IN THIS PHOTO:

RAM-B-166-GOP1U

RAM® Twist-Lock™ Suction Cup Mount with Universal Action Camera Adapter



**BEST
SELLER**

RAM-B-166-A-GOP1U

RAM® Twist-Lock™ Suction Cup Mount with Universal Action Camera Adapter



RAP-B-202-GOP1-354-TRA1U

RAM® Track Ball™ Universal Action Camera Mount



RAP-B-GOP2-A-GOP1U

RAM® Ball Adapter for GoPro® Bases with Universal Action Camera Adapter



RAP-B-378-202U-GOP1

RAM® Flex Adhesive Double Ball Mount with Action Camera Adapter

SEEN IN THIS PHOTO:

RAM-HOL-SP05U

RAM® EZ-Roll'r™ Cradle for SPOT X™

RAM-B-166U

RAM® Twist-Lock™ Suction Cup Double Ball Mount



RAM-HOL-SP05U

RAM® EZ-Roll'r™ Cradle for SPOT X™



RAM-B-202-GA76U

RAM® Spine Clip Holder with Ball for Garmin Handheld Devices



DEVICE HOLDERS CONTINUED

GPS FORM-FIT HOLDERS

The form-fit and EZ-Roll'r™ designs carry over to GPS devices in addition to holders utilizing the revolutionary Garmin Spine Clip, each capable of transferring between your vehicles, allowing you to navigate safely and hands-free. Widescreen GPS devices can also take advantage of the locking holders that provide extra protection and sport an integrated sun visor.

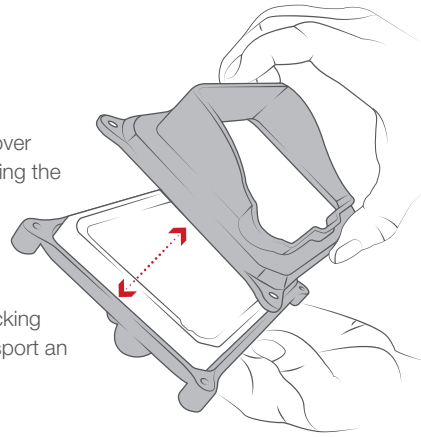

RAM® EZ-Roll'r™ design protects device when inserting and removing

FEATURES

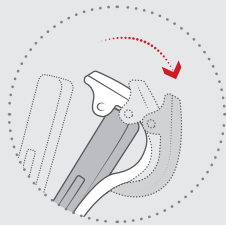

Patented roller design protects device and makes the insertion & removal of GPS easy

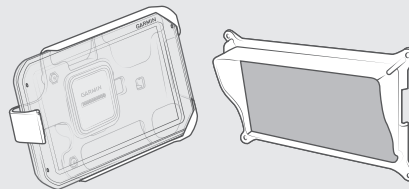

Custom form-fit and universal holders available

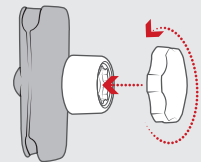

Security & locking options available



SEEN IN THIS PHOTO:

RAM-B-149Z-A-GA76U
 RAM® Spine Clip Garmin
 Mount with Handlebar
 U-Bolt Base

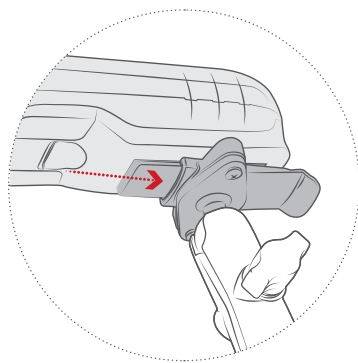

**BEST
 SELLER**

RAM-B-166-GA76U
 RAM® Suction Cup Garmin
 Spine Clip Holder



RAM-HOL-GA75LU
 RAM® EZ-Roll'r™ Locking Cradle for
 Garmin Fleet 770, Overlander + More



RAM-HOL-GA71LU
 RAM® Form-Fit Locking Cradle for
 Garmin Dezl 570LMT



RAM-B-138L-GA75LU
 RAM® EZ-Roll'r™ Drill-Down Mount for Garmin
 Fleet 770, Overlander + More



RAM-B-138-S5-GA66LU
 RAM® Pin-Lock™ Drill-Down Locking Mount for
 Garmin fleet 660/670



RAM-B-166-GA55U
 RAM® Twist-Lock™ Suction Cup Mount for
 Garmin nuvi 52, 54, 55, 56 & 58

FEATURES

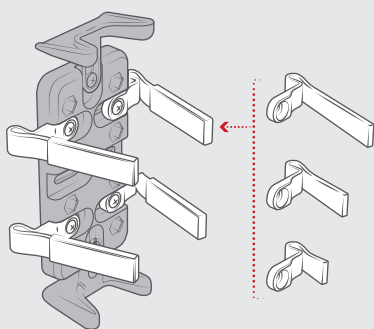

Different finger sizes to accommodate different device thicknesses

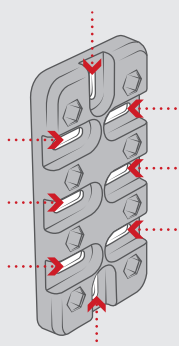

Multiple slotted holes to accommodate buttons and ports

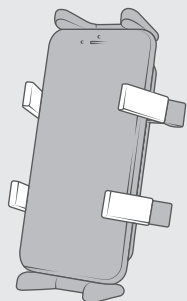

Rubber caps to create friction and firm grip against device



Made of high-strength composites for durability and reliability in the most demanding environments

DEVICE HOLDERS CONTINUED

RADIO HOLDERS - CB, HAM, & HANDHELD

Doubling down on our “universal first” approach, radio communication devices of all kind benefit from the patented RAM® Finger-Grip™ equipped with adjustable and movable “fingers” to modify the grip of the holder to accommodate various sizes of handheld radios. All of our microphone accessories have been designed to complement our modular product by containing matching hole patterns, different sizes and lengths and bracket configurations for a truly custom mounting solution with peripheral add-on potential.

HOLDERS



RAM-HOL-BC1U
RAM® Universal Belt Clip Holder



RAM-HOL-UN4U
RAM® Finger-Grip™ Universal Phone and Radio Holder

MICROPHONE - HOLDERS & ACCESSORIES



RAM-MIC-A01
RAM® Microphone with Steel Mounting Clip



RAM-VC-MC
RAM® Tough-Box™ Console Microphone Clip



RAM-VC-MC1M
RAM® Tough-Box™ Console Magnetic Microphone Clip



RAM-101-MIC1U
RAM® Short Bracket Adapter for Speakers & Microphones



RAM-101-MIC2U
RAM® Standard Bracket Adapter for Speakers & Microphones

SEEN IN THIS PHOTO:

RAM-HOL-UN4U

RAM® Finger-Grip™ Universal GPS and Radio Holder

RAM-B-103-238U

RAM® Double Socket Arm with Diamond Plate

RAM-B-407U

RAM® Tough-Wedge™ Base with Ball



RAM-B-101U

RAM® Universal Double Ball Mount with Two Round Plates



RAM-101U

RAM® Double Ball Mount with Two Round Plates



RAM-111U

Drill-Down, Medium Arm, Overall Height 7.35"



RAM-B-111U

RAM® Universal Marine Electronic Mount

SEEN IN THIS PHOTO:

RAP-365-224-1BU

RAM® Twist-Lock™ Triple Suction Cup Base with AMPS Hole Pattern

RAM-B-217U

RAM® Double Ball Adapter with Round Base

RAM-B-201U-C

RAM® Double Socket Arm

RAM-B-238U

RAM® Diamond Ball Base

RAM-HOL-UN14WB

RAM® Quick-Grip™ Waterproof Wireless Charging Holder

RAM-VC-MC

RAM® Tough-Box™ Console Microphone Clip

RAM-B-202U

RAM® Round Plate with Ball



DEVICE HOLDERS CONTINUED

MICS & MICROPHONE CLIPS

Complete your communications system by enabling Push-to-talk features with the help of add-ons, such as the RAM® Microphone and microphone clip accessory brackets to pair with a GDS® Audio™ Amplified speaker. No matter how robust you want to take it, the versatility of RAM® components makes it easy to build a system that best suits the needs of large enterprises, smaller operations and everything in between.

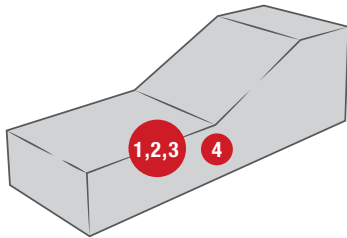

RAM® Tough-Box™ Console

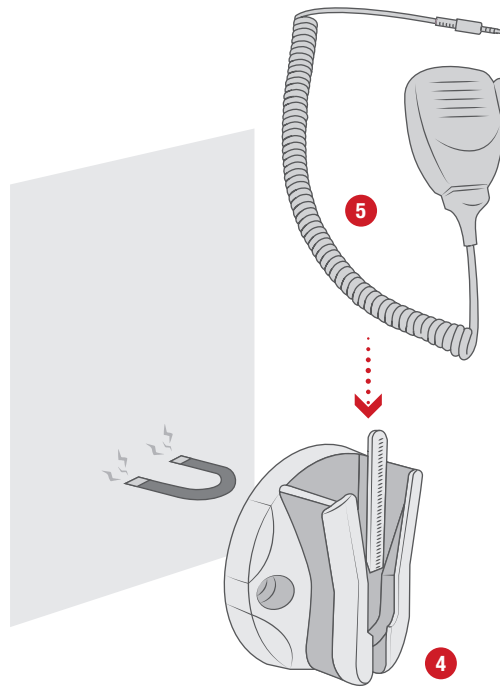

+ GO TO PAGE 37 TO SEE THE COMPLETE RAM® TOUGH-BOX™ WITH ACCESSORIES

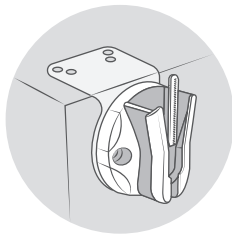

1

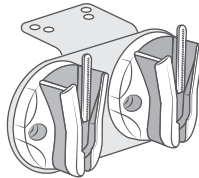

2

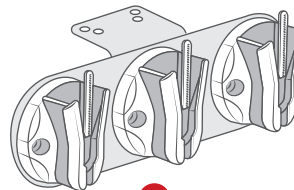

3



1

RAM-VC-MC1

RAM® Tough-Box™ Console Microphone Clip with 90-Degree Bracket



2

RAM-VC-MC2

RAM® Tough-Box™ Double Microphone Clip with 90-Degree Bracket



3

RAM-VC-MC3

RAM® Tough-Box™ Triple Microphone Clip with 90-Degree Bracket



4

RAM-VC-MC1M

RAM® Tough-Box™ Console Magnetic Microphone Clip



5

RAM-MIC-A01

RAM® Microphone with Steel Mounting Clip



RAM-SPEAK-A01

GDS® Audio™ Amplified Speaker



RAM-SPEAK-A02

GDS® Audio™ Amplified Speaker with PTT Breakout Feature



DEVICE HOLDERS CONTINUED

RAM® TOUGH-BOX™

The RAM® Tough-Box™ sets the industry standard for law enforcement vehicle consoles. Available in vehicle-specific all-in-one kits, the RAM® Tough-Box™ can also be built from scratch with a wide selection of console lengths, leg kits, top plates, faceplates, fillers, and more.

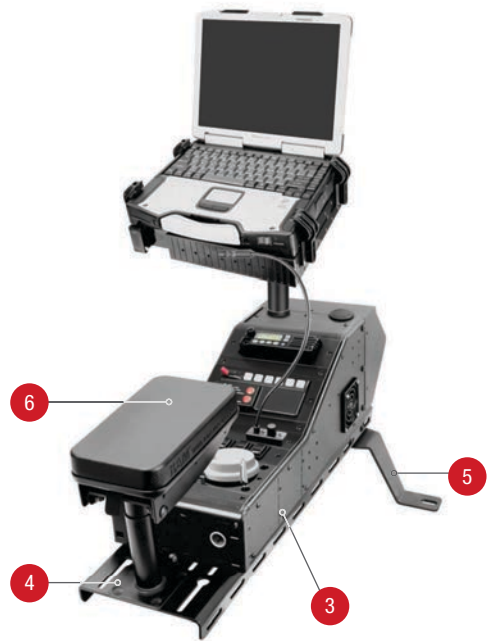

1 RADIO FACEPLATES Hundreds of plate sizes and cuts to accommodate most radio units including Cobra, Kenwood, Midland, Whelen and more



2 ACCESSORY AND FILLER FACEPLATES Complete your Console Box with filler and accessory plate options



CUP HOLDERS

ACCESSORY POCKETS

SWITCH & CHARGER PLATES

FILLER PLATES

3 CONSOLE BOXES Various box sizes to accommodate all desired devices and accessories



9" STRAIGHT BOX

17" STRAIGHT BOX

21" STRAIGHT BOX

ANGLED BOX WITH TELE-POLES

4 TOP PLATES Plate adapters that connect the Leg Kits to the Console Box



29" TOP PLATE

23" TOP PLATE

5 LEG KITS Various leg kit styles connect your Console Box with Top Plate to your specific vehicle



FORD

DODGE

CHEVROLET

UNIVERSAL

6 ACCESSORIES Select custom parts and accessories to build the perfect mobile interface for your vehicle

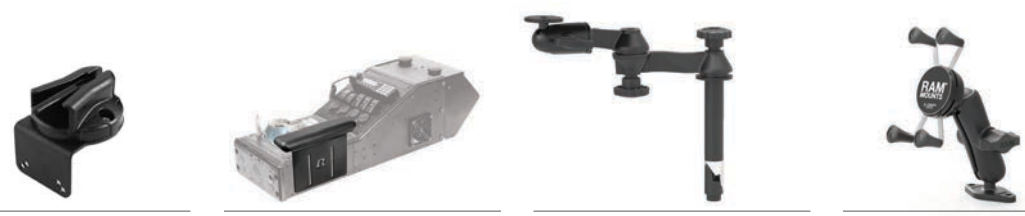

MICROPHONE CLIPS

ARM RESTS

TELE-POLE SWING ARM MOUNTS

PHONE MOUNTS

SEEN IN THIS PHOTO:

RAM-VPR-104-1

RAM® Quick-Draw™ Jr. with Double
U-Bolt Base for Small Printers



DEVICE HOLDERS CONTINUED

PRINTER HOLDERS

RAM® printer cradles are the ideal solution for your mobile office, allowing you to mount a wide range of portable wireless printers in your vehicle. See the RAM® Quick-Draw™ holder for universal solutions as it expands to cradle your printer perfectly no matter what size it may be.



RAM-VPR-101
Brother PocketJet Series

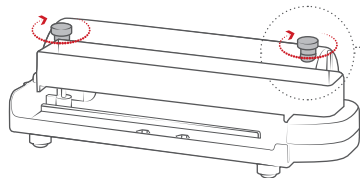

Custom form-fit holders for Brother PocketJet & RuggedJet Series

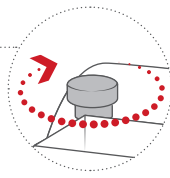

To expose the paper simply lose the knobs

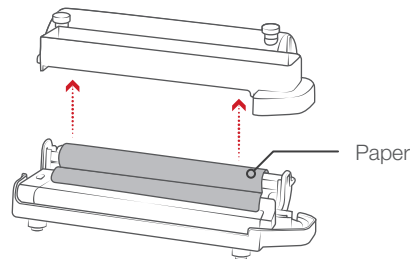

Paper



RAM-VPR-104-1
RAM® Quick-Draw™ Jr. with Double U-Bolt Base for Small Printers



RAM-VPR-103-1
RAM® Quick-Draw™ Jr. with Double U-Bolt Base for HP OfficeJet 100, 150 & 250



RAM-VPR-106-1
RAM® Printer Cradle with U-Bolt Mount for Brother RuggedJet + More



RAM-VPR-101-1
RAM® U-Bolt Mount with Printer Cradle for Brother PocketJet + More



RAM-VPR-103
HP OfficeJet 100, 150 & 250



RAM-VPR-106
Brother RuggedJet Series



RAM-101U
Mount your printer to the Tele-Pole of your RAM® Laptop Mount, or mount to center console using Universal Double Ball Mount



RAM-VPR-104
RAM® Quick-Draw™ Jr. Universal Small Printer Holder

FEATURES

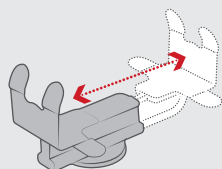

Spring-loaded universal holders offer convenient insertion and removal



Made of durable steel and high strength composite materials

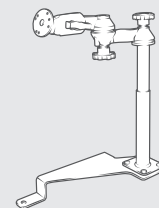

Mount to the RAM® Tele-Pole or console of your vehicle



SEEN IN THIS PHOTO:

RAM-GDS-SKIN-AP15
IntelliSkin® for the Apple iPad 5th and 6th Gen

RAM-GDS-DOCKL-V2-AP8U
GDS® Locking Vehicle Dock for Apple iPad 5th & 6th Gen and Pro 9.7

TOW

VEHICLE MOUNTS

FEATURED PRODUCTS

Vehicle mounts are truly customizable to fit all your devices in the cockpit of your vehicle. From RAM® No-Drill™ mounts to a standard X-Grip® phone mount, all of our vehicle mounts are stackable to create your own mini ecosystem of devices. Choose from phone mounts, tablet mounts, laptop, GPS, action cameras, handheld radios and more.

PHONE MOUNTS



RAM-B-166-UN7U

RAM® X-Grip® Phone Mount with RAM® Twist-Lock™ Suction Cup Base



RAP-B-299-4-UN10U

RAM® X-Grip® Large Phone Mount with RAM® Stubby™ Cup Holder



RAM-B-166-UN12W

RAM® Twist-Lock™ Suction Cup Mount

TABLET MOUNTS

**BEST
SELLER**



RAM-B-189-PIV1-UN11U

RAM® X-Grip® with RAM® Twist-Lock™ Pivot Suction for 12" Tablets



RAM-VB-196-SW2

RAM® No-Drill™ Universal Vehicle Floor Mount



RAM-316-HD-18-202U

RAM® Pod HD™ Vehicle Mount with 18" Aluminum Rod and Round Plate

LAPTOP MOUNTS



RAM-VB-195-SW1

RAM® No-Drill™ Laptop Mount for '17-20 Ford F-Series + More



RAM-VB-178A-SW1

RAM® No-Drill™ Laptop Mount for '12-20 RAM 2500-5500 + More



RAM-VB-203-SW1

RAM® No-Drill™ Laptop Mount for '19-20 Chevy Silverado + More

GPS AND CAMERA MOUNTS



RAM-B-166-GOP1U

RAM® Twist-Lock™ Suction Cup Mount with Universal Action Camera Adapter



RAM-B-372-DEL1

RAM® Twist-Lock™ Suction & Drill-Down Mount for Delorme Earthmate + More



RAM-B-138L-GA75LU

RAM® EZ-Roll'r™ Drill-Down Mount for Garmin Fleet 770, Overlander + More

RIGGING MAP

With multiple mounting bases to choose from, we've mapped out the most popular mounting locations to help you decide where you would like to mount your devices. Choose from windshield mounting, dashboard mounting, floor mounting and more.



1 **RAM-B-166U**
 RAM® Twist-Lock™ Suction Cup Double Ball Mount (pg. 46)
RAM-HOL-AP33U
 RAM® Form-Fit Cradle for Apple iPhone 12 & 12 Pro (pg. 20)



2 **RAM-B-166-UN12W**
 RAM® Tough-Charge™ Waterproof Wireless Charging Suction Cup Mount (pg. 41)



3 **RAP-279C**
 RAM® Portable Friction Dashboard Base (pg. 52)
RAM-B-166-GOP1U
 RAM® Twist-Lock™ Suction Cup Mount with Universal Action Camera Adapter (pg. 30)



4 **RAP-B-407-UN10U**
 RAM® Tough-Wedge™ with Double Socket Arm and Round Plate (pg. 57)
RAM-HOL-TAB30U
 RAM® Tab-Tite™ Tablet Holder for Samsung Galaxy Tab S2 8.0 + More (pg. 23)



5 **RAP-B-299-4-238U**
 RAM® Stubby™ Cup Holder Mount with Diamond Plate (pg. 56)
RAM-HOL-UN4U
 RAM® Finger-Grip™ Universal GPS and Radio Holder (pg. 33)



6 **RAM-VB-195-SW1**
 RAM® No-Drill™ Laptop Mount for '17-21 Ford F-250 - F-550 + More (pg. 66)



1 **RAP-B-378-UN7U**
RAM® X-Grip® Phone Mount with Flex Adhesive Base (pg. 50)



2 **RAM-VB-196-GDS-EC01**
GDS® Ecosystem™ Vehicle Bundle with Monitor, Keyboard & Phone Mount (pg. 104)



2 **RAM-GDS-101B-SAM67CU**
GDS® Tough-Dock™ USB Type-C Vehicle Bundle for Samsung Tab A 8.4 (pg. 72)



1 **RAM-B-166U**
RAM® Twist-Lock™ Suction Cup Double Ball Mount (pg. 46)

RAM-GDS-DOCK-V1U
GDS® Vehicle Phone Dock with USB Type-C for IntelliSkin® Products (pg. 82)

RAM-GDS-SKIN-SAM71
IntelliSkin® for Samsung Galaxy S20 Ultra 5G (pg. 78)



3 **RAM-316-HD-18-202U**
RAM® Pod HD™ Vehicle Mount with 18" Aluminum Rod and Round Plate (pg. 42)

RAM-HOL-SAM60PU
RAM® EZ-Roll'r™ Powered Cradle for Samsung Tab Active3 and Tab Active2 (pg. 42)

SEEN IN THIS PHOTO:

RAM-B-166-UN7U

RAM® X-Grip® Phone Mount with
RAM® Twist-Lock™ Suction Cup



SEEN IN THIS PHOTO:

RAM-B-166-GA46

RAM® Twist-Lock™ Suction Cup Mount
for Garmin Montana 600 Series



VEHICLE MOUNTS CONTINUED

WINDSHIELD MOUNTING

RAM® TWIST-LOCK™ & RAM® MIRROR-MATE™

The RAM® Twist-Lock™ Suction Cup has a strong hold on glass and non-porous surfaces. Pair it with your favorite action camera, or with the universal RAM® X-Grip® phone cradle for a safe and accessible solution for phones of all sizes.



BEST SELLER

RAM-B-224-1U

RAM® Twist-Lock™ Suction Cup Base with Ball



RAM-B-189B-202U

RAM® Twist-Lock™ Dual Suction Cup Base with Ball



RAM-365-224-1U

RAM® Twist-Lock™ Triple Suction Cup Base with Ball

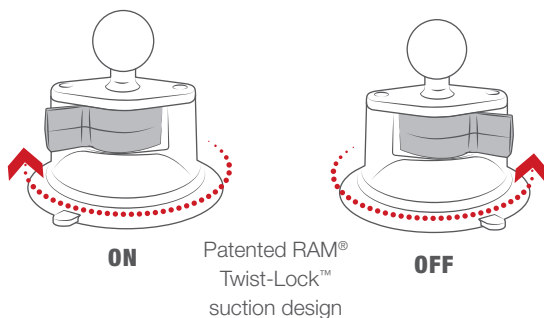

RAP-B-369AU

RAM® Mirror-Mate™ Ball Base for Chrysler, Ford & Toyota



RAM-B-231Z-RVMU

RAM® U-Bolt Ball Base for Rear View Mirrors

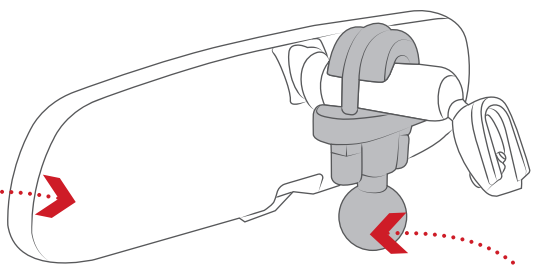

RAM® U-Bolt ball base for rear view mirrors

RAM® TWIST-LOCK™ FEATURES

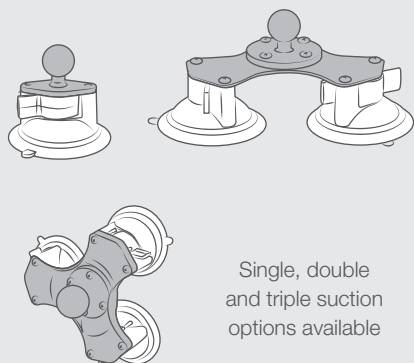

Single, double and triple suction options available

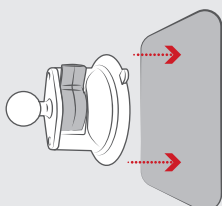

Holds strong against any windshield or non-porous surface



Ideal for any phone, GPS or camera



SEEN IN THIS PHOTO:

RAM-HOL-ZE7U

RAM® Form-Fit Powered Holder for Zebra TC70, 72, 75 & 77

RAM-138U

RAM® Double Ball Mount with Diamond Plate Adapter



SEEN IN THIS PHOTO:

RAM-HOL-AP20U

RAM® EZ-Roll'r™ Cradle for Apple iPad mini 4 & 5

RAM-B-101U-C

RAM® Universal Double Ball Mount with Two Round Plates

VEHICLE MOUNTS CONTINUED

DASHBOARD MOUNTING

RAM® DRILL-DOWN

RAM® Drill-Down bases double as ball adapters for the back of most of our holders and for a sturdy mounting base utilizing the universal 2-hole diamond and 4-hole AMPS patterns. Drill-down bases are by far our strongest bases by using mounting hardware for mounting to flat surfaces in ultra-rugged environments.

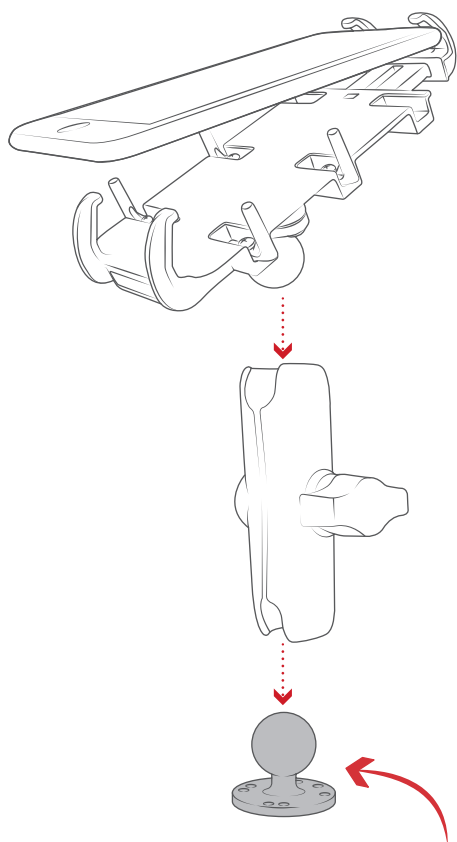

B size 1" RAM® rubber ball allows for connection to any B size RAM® double socket arm; ball and socket technology allows for near-infinite adjustability



RAM-B-202U
RAM® Round Plate with Ball



RAM-B-217U
RAM® Double Ball Adapter with Round Base



RAM-202-225BU
RAM® Backing Plate Adapter



RAM-B-347U
4-Hole AMPS Rectangular Drill-Down Base



RAM-B-238U
2-Hole AMPS Diamond Drill-Down Base

POPULAR MOUNTS



RAM-B-138-PD4U
Drill-down Mount

BEST SELLER



RAM-B-138-UN10
RAM® X-Grip® Large Phone Mount with Drill-Down Base



RAM-B-138-GA76U
RAM® Drill-Down Mount with Garmin Spine Clip Holder



RAM-B-101-225B-SAM60P-HARU
RAM® EZ-Roll'r™ Powered Mount for Samsung Tab Active3 & Tab Active2 with Backing Plate



SEEN IN THIS PHOTO:

RAP-B-378-UN10U
Flex Adhesive Mount with
Universal RAM® X-Grip®
Phone Holder

DID YOU KNOW

Some states and countries prohibit the use of suction cup mounts and other obstructions on the windshield, making the adhesive mounts an ideal mounting solution.



SEEN IN THIS PHOTO:

RAM-GDS-SKIN-SAM14U

IntelliSkin® for the
Samsung Galaxy S6

RAM-GDS-DOCK-V1U

Universal GDS® Vehicle
Phone Dock

RAP-SB-180U

RAM® Lil Buddy™ Adhesive
Stick Base Dash Mount

FEATURES

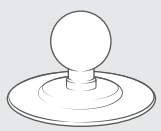

2.5" Diameter base for most dashboards

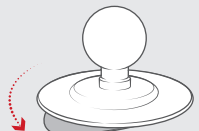

Flexible base conforms to flat or curved dash surfaces

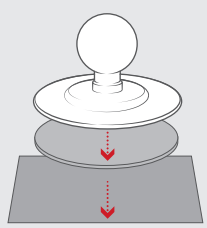

Powerful 3M adhesive for any hard, smooth or textured surfaces

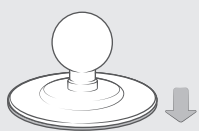

Low profile and double ball mount options available

VEHICLE MOUNTS CONTINUED

DASHBOARD MOUNTING FLEX ADHESIVE MOUNTS

The Flex Adhesive Double Ball Mount and RAM® Lil-Buddy™ uses an adhesive disk that you can place practically anywhere you want to mount your device, so it's easy to see and always within your reach without attaching to your windshield, or drilling into your dashboard. Mounting either a phone, or tablet, you can customize your mount with any B size RAM® components. Designed with a very small footprint, finding a home on your dash, or console won't be a problem.



RAP-SB-180-UN7U
RAM® X-Grip® Phone Holder with Lil Buddy™ Adhesive Dash Mount

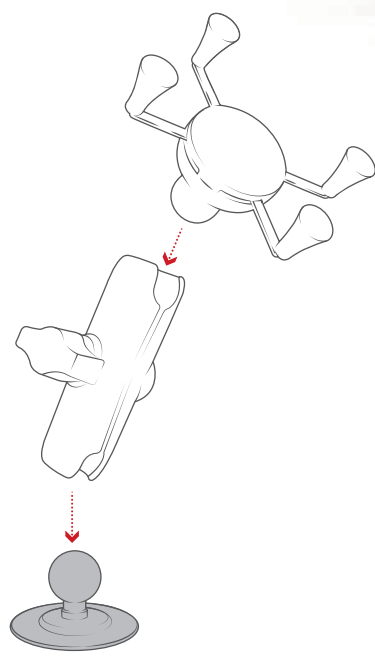

RAP-B-378-UN10U



RAP-B-378U
RAM® Flex Adhesive Ball Base

POPULAR MOUNTS



RAP-SB-180-GDS-DOCK-V1U
GDS® Powered Phone Dock with RAM® Lil Buddy™ Adhesive Dash Mount



RAP-B-378-202U-GOP1
RAM® Flex Adhesive Double Ball Mount with Action Camera Adapter



RAP-B-378-UN8U
RAM® X-Grip® with Flex Adhesive Base for 7"-8" Tablets



RAP-B-378-UN10U
RAM® X-Grip® Large Phone Mount with Flex Adhesive Base

SEEN IN THIS PHOTO:

RAP-279C

RAM® Portable Friction Dashboard Base

RAM-B-166-UN7U

RAM® X-Grip® Phone Mount with RAM® Twist-Lock™ Suction Cup



SEEN IN THIS PHOTO:

RAP-279C

RAM® Portable Friction Dashboard Base

RAM-B-166-UN14W

RAM® Quick-Grip™ Waterproof Wireless Charging Suction Cup Mount



VEHICLE MOUNTS CONTINUED

DASHBOARD MOUNTING

RAM® PORTABLE FRICTION DASHBOARD BASE & RAM® ADHESIVE DASHBOARD BASE

The Portable Friction Dashboard Base for Suction Cups is an excellent solution for mounting a suction cup system to your dashboard or anywhere with a textured surface. For those who do not want to attach objects to their windshields or do not wish to drill into their dashboards, this is the perfect solution for you. The weighted friction base simply sits anywhere on the dashboard requiring no installation, while keeping the mount and your device from sliding off the dashboard.

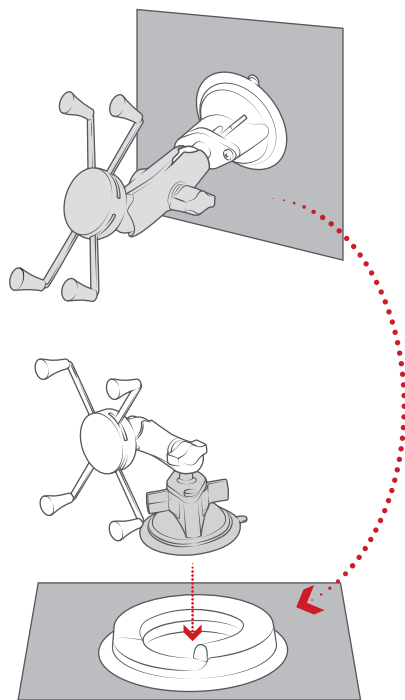

Brings your suction cup from windshield to dashboard



**BEST
SELLER**

RAP-279C

RAM® Portable Friction Dashboard Base



RAP-350-35BU

RAM® Black 3.5" Adhesive Plate for Suction Cups

FEATURES

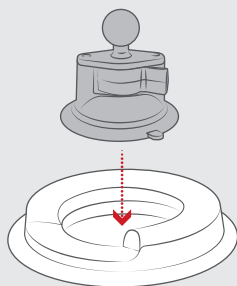

Supports any RAM® Suction Cup Base

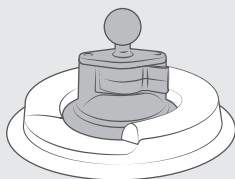

Weighted friction base keeps suction cup mount secure

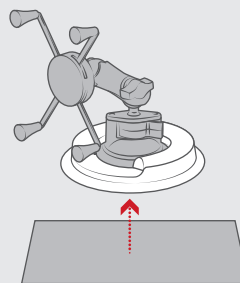

Conveniently stow away when not in use



SEEN IN THIS PHOTO:

RAM-B-MAG66U
RAM® Tough-Mag™
66MM Diameter Ball Base

RAM-343-PU
RAM® Steel Adhesive
Plate Adapter for
Magnetic Mounts

RAM-B-201U
RAM® Double Socket Arm

RAM-HOL-UN10BU
RAM® X-Grip® Large
Phone Holder with Ball

DASHBOARD MOUNTING

MAGNETIC MOUNTING

Not a fan of drilling into your mounting surface? RAM® offers a magnetic option for flat metal surfaces. The RAM® Tough-Mag™ leverages 6 to 12 integrated magnets and a B, or C size ball attachment to mount your device quickly with no hassle. These magnetic bases open the imagination for all kinds of device mounting including inventive GoPro placement, lights in the garage, or maybe a forklift's square post.



**BEST
SELLER**

RAM-B-MAG66U
RAM® Tough-Mag™ 66MM
Diameter Base
with 1" (B) Ball

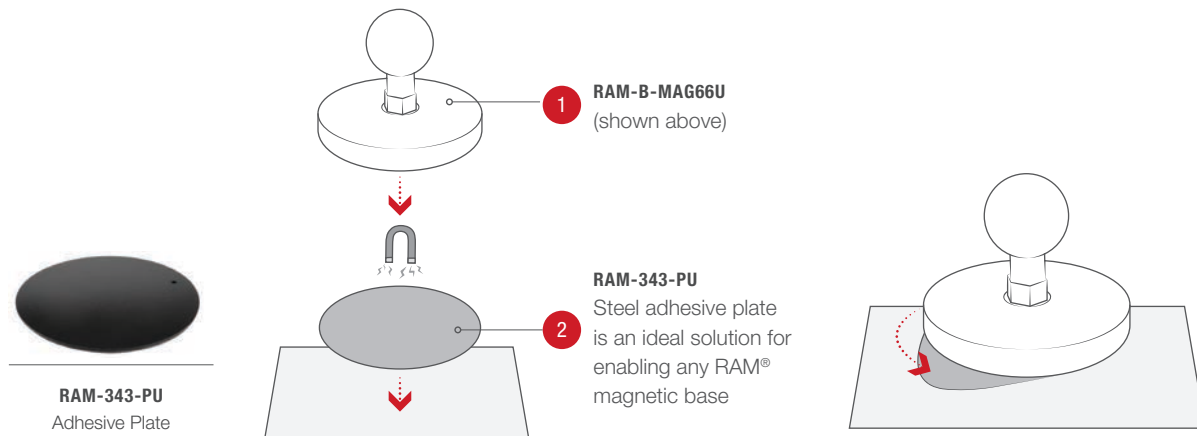
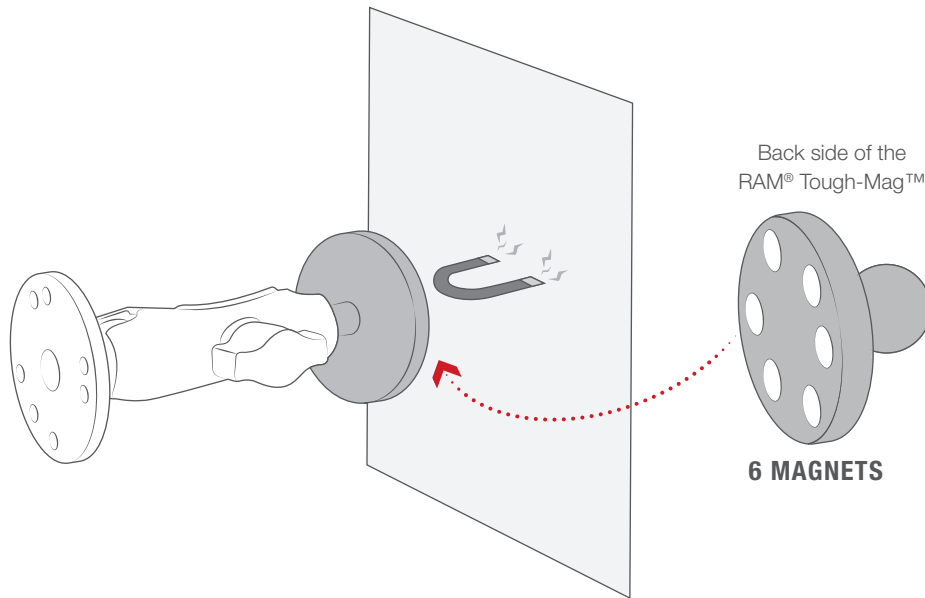

DID YOU **KNOW**

Unlike most cup holder mounts, the RAM-A-CAN™ II and RAM® Stubby™ contain an internal weighted insert that keeps the base stable and secure.

SEEN IN THIS PHOTO:

RAP-B-299-4-UN7U
RAM® X-Grip® Phone Mount with RAM® Stubby™ Cup Holder Base



FEATURES

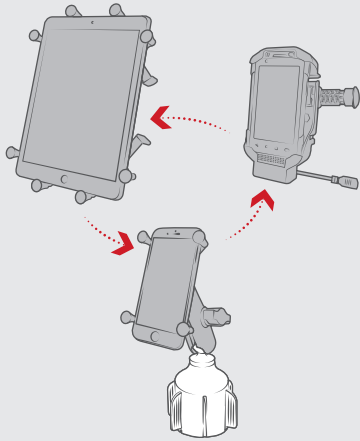

Weighted bases can support phones, small tablets and other handheld devices



Secure yet temporary mount that does not require any drilling

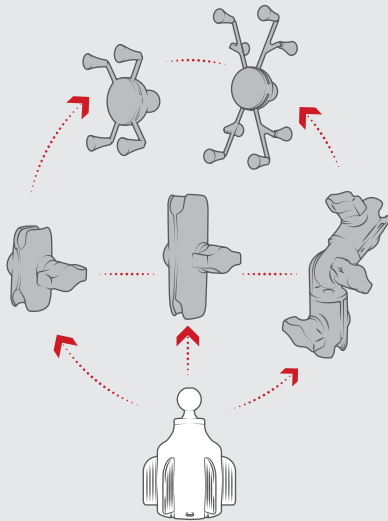

Compatible with any B size ball & socket components

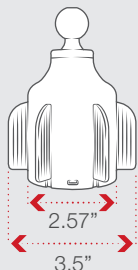

Fits any cup holder from 2.57" - 3.5" in diameter

VEHICLE MOUNTS CONTINUED

**CUP HOLDER MOUNTING
RAM® STUBBY™ &
RAM-A-CAN™ II**

With a durable composite shell and flexible support fins, the RAM® Stubby™ and RAM-A-CAN™ II bases are portable and versatile mounting solutions for your vehicle's cup holders.



RAP-B-299-4U
RAM® Stubby™ Cup Holder Ball Base

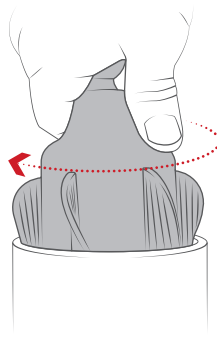

Insert and twist the Stubby™ into your cup holder to create proper friction.



RAP-299-3U
RAM-A-CAN™ II Universal Cup Holder Base



RAP-B-299-4-UN7U
RAM® Stubby™ Cup Holder Mount



RAP-B-299-4-UN10U
RAM® X-Grip® Large Phone Mount with RAM® Stubby™ Cup Holder



RAP-299-3-UN8U
RAM® X-Grip® with RAM-A-CAN™ II Cup Holder Mount for 7"-8" Tablets



RAM-B-299-3-TAB30U
RAM® Tab-Tite™ Cup Holder Mount for Samsung Galaxy Tab S2 8.0 + More



SEEN IN THIS PHOTO:

RAP-B-407-UN8U

RAM® X-Grip® Mount with RAM® Tough-Wedge™ for 7"-8" Tablets

VEHICLE MOUNTS CONTINUED

SEAT MOUNTING

RAM® TOUGH-WEDGE™

Drop in the RAM® Tough-Wedge™ for a quick and easy device mount that doubles as a barrier for dropping items in between the seats. This easily removable solution is perfect for long drives with the kids by simply swapping the Tough-Wedge™ around to face the back seat—add a tablet holder and you've successfully converted the back seat into a movie theater.



RAP-407-PUMPU

RAM® Tough-Wedge™ Expansion Pouch Accessory



RAM-B-407-C-202-PUMPU

RAM® Tough-Wedge™ Mount with Round Plate & Expansion Pouch



RAM-B-407-201-C-PUMPU

RAM® Tough-Wedge™ Mount with Double Socket Arm & Expansion Pouch



RAM-B-407U

RAM® Tough-Wedge™ Base with Ball

**BEST
SELLER**



RAM-B-407-PUMPU

RAM® Tough-Wedge™ Base with Ball and Expansion Pouch



RAM-B-407-201-C-TAB3U

RAM® Tab-Tite™ with RAM® Tough-Wedge™ Mount for 10" Tablets



RAP-B-407-UN7U

RAM® X-Grip® Phone Mount with RAM® Tough-Wedge™ Base



RAP-B-407-UN10U

RAM® X-Grip® Large Phone Mount with RAM® Tough-Wedge™ Base

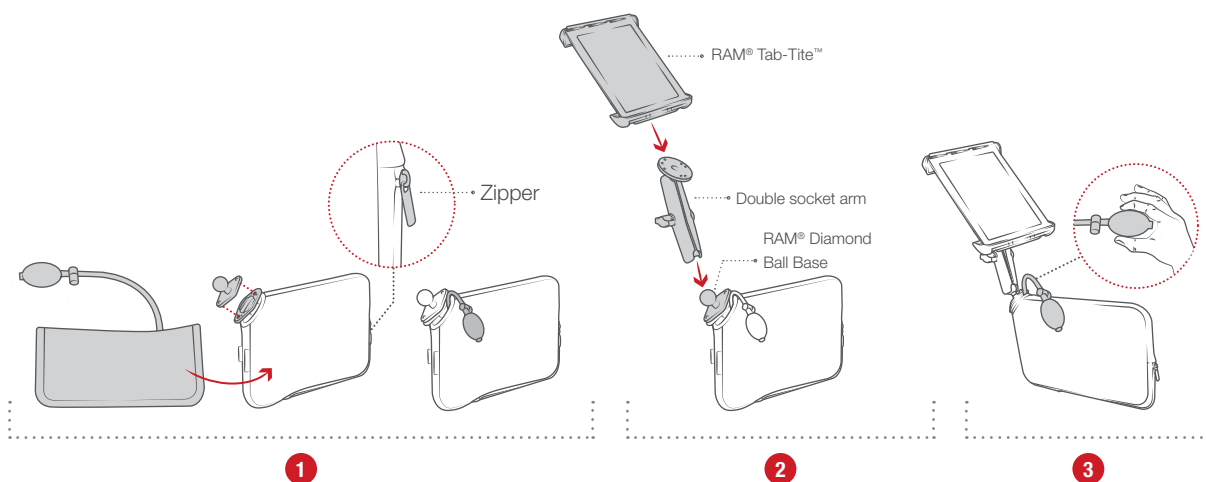

1

Place inflatable pouch inside of the zipper opening of the RAM® Tough-Wedge™. Secure the rubber ball joint to the head of the RAM® Tough-Wedge™

2

Place the RAM® Tab-Tite™ over the double socket arm, place this into the rubber ball joint, which is affixed to the RAM® Tough-Wedge™

3

Using the pump, inflate the RAM® Tough-Wedge™, and secure it into the seat gap

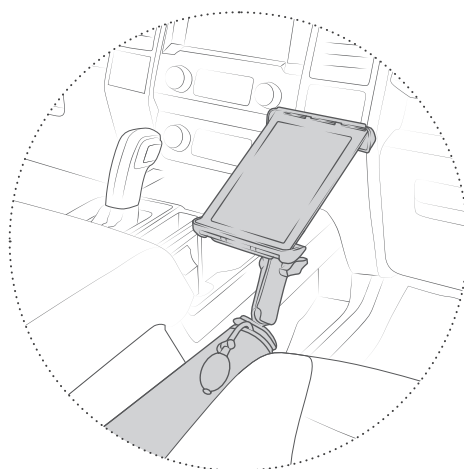

The inflated RAM® Tough-Wedge™ will conform into the seat gap, creating stability inside of your vehicle.

FEATURES



Secures quickly to passenger seat without having to remove at seat bolts

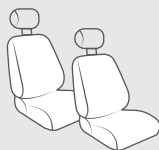

Functions as a front seat and backseat passenger mount

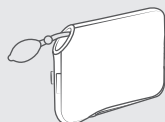

Expansion pouch accessory creates incredible hold in vehicle

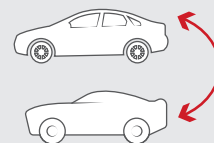

Quickly transfer to other vehicles, or stow when not in use

SEEN IN THIS PHOTO:

RAM-TRACK-EXA-5

5" Modular Aluminum RAM® Tough-Track™

RAP-B-354U-TRA1

RAM® Track Ball™ with T-Bolt Attachment

RAP-HOL-UN7B-354-TRA1U

RAM® X-Grip® Phone Mount with RAM® Track Ball™ Base



SEEN IN THIS PHOTO:

RAM-TRACK-EXA-5

5" Modular Aluminum
RAM® Tough-Track™

RAP-B-202-GOP1-354-TRA1U

RAM® Track Ball™ Universal
Action Camera Mount

RAP-B-354U-TRA1

RAM® Track Ball™ with
T-Bolt Attachment



VEHICLE MOUNTS CONTINUED

RAM® TOUGH-TRACK™ MODULAR ALUMINUM

Using a track mounting system is a clean, clever and innovative way to mount devices in your vehicle. With the RAM® Tough-Track™, customize your system with a variety of track lengths and components for top-loading and end-loading functionality.



■ **RAM-TRACK-EXA-3U**
3" Modular Aluminum
RAM® Tough-Track™

■ **RAM-TRACK-EXA-5U**
5" Modular Aluminum
RAM® Tough-Track™

■ **RAM-TRACK-EXA-9U**
9" Modular Aluminum
RAM® Tough-Track™

■ **RAM-TRACK-EXA-13U**
13" Modular Aluminum
RAM® Tough-Track™

■ **RAM-TRACK-EXA-17U**
17" Modular Aluminum
RAM® Tough-Track™

■ **RAM-TRACK-EXA-3BU**
3" Modular Aluminum
Black RAM®
Tough-Track™

■ **RAM-TRACK-EXA-5BU**
5" Modular Aluminum
Black RAM®
Tough-Track™

■ **RAM-TRACK-EXA-9BU**
9" Modular Aluminum
Black RAM®
Tough-Track™

■ **RAM-TRACK-EXA-13BU**
13" Modular Aluminum
Black RAM®
Tough-Track™

■ **RAM-TRACK-EXA-17BU**
17" Modular Aluminum
Black RAM®
Tough-Track™

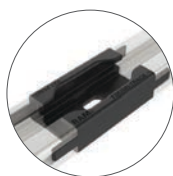

RAP-TRACK-EXA-CCU
RAM® Center Connector
for Modular Aluminum
RAM® Tough-Track™

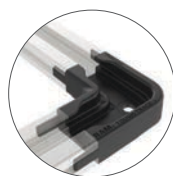

RAP-TRACK-EXA-CC90U
RAM® 90-Degree Connector
for Modular Aluminum
RAM® Tough-Track™

FEATURES



High strength materials support multiple-device mounting



Drill to any flat surface with #8 screws

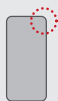

No sharp edges

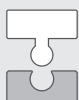

Modular track extensions for additional length



Low-profile design

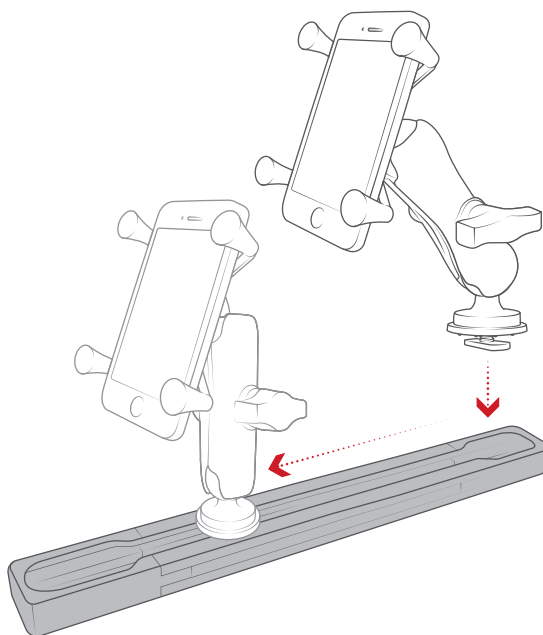



VEHICLE MOUNTS CONTINUED

RAM® TOUGH-TRACK™
RAM® TOUGH-TRACK™
FOR JEEP JLS & GLADIATORS

The RAM® Tough-Track™ for the dash of 2018-2021 Jeep JL/Gladiator vehicles creates an ideal device setup for overland and off road enthusiasts. Consisting of a dash mounting plate and a top-loading composite 12" RAM® Tough-Track™, easily attach RAM® Track Ball™ components along with double socket arms and device holders for phones, small tablets, GPS units, radios, cameras, and more.



RAM-DT-204-TRACK-A12U

RAM® Tough-Track™ for 18-21' Jeep JL/Gladiator

Integrates into dash of compatible Jeep vehicles using OEM screws, with no drilling or modifications necessary

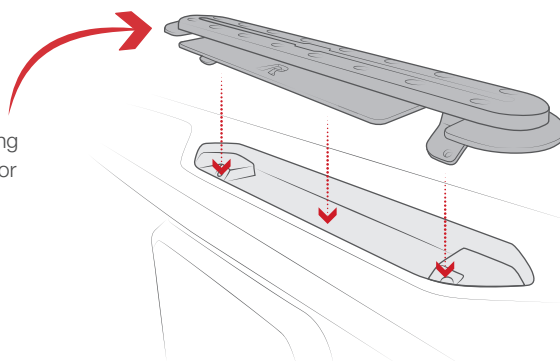

FEATURES



High strength materials support multiple-device mounting

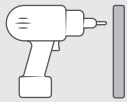

Drill to any flat surface with #10 screws for the top-loading composite and for the RAM® Hand-Track™ with #14 or 1/4"-20 screws

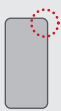

No sharp edges



Low-profile design

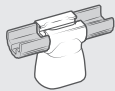

Compatible with RAM® Hand-Track™ extensions



Mounting holes are outside in the top-loading composite track for reinforced stability

RAM® TOUGH-TRACK™







RAM® HAND-TRACK™

Using a track mounting system is a clean, clever and innovative way to mount devices in your vehicle. With the RAM® Tough-Track™, customize your system with a variety of track lengths and components for top-loading and end-loading functionality.

BEST SELLER

			
RAM-TRACK-H4U 4" RAM® Hand-Track™ with 10" Overall Length	RAM-TRACK-H6U 6" RAM® Hand-Track™ with 12" Overall Length	RAM-TRACK-H8U 8" RAM® Hand-Track™ with 14" Overall Length	RAM-TRACK-H10U 10" RAM® Hand-Track™ with 16" Overall Length
			
RAM-TRACK-H12U 12" RAM® Hand-Track™ with 18" Overall Length	RAM-TRACK-H15U 15" RAM® Hand-Track™ with 21" Overall Length	RAM-TRACK-H18U 18" RAM® Hand-Track™ with 24" Overall Length	
			
RAM-TRACK-H30U 30" RAM® Hand-Track™ with 36" Overall Length	RAM-TRACK-HC-6U RAM® Hand-Track™ Center Connector with 6" Track Extension		

TOP-LOADING COMPOSITE

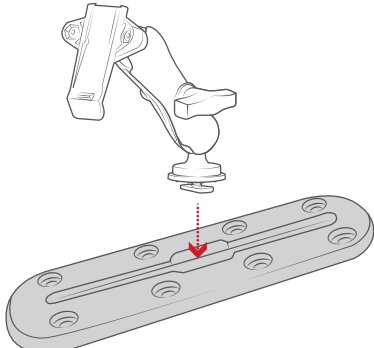
			
RAP-TRACK-A2U RAM® Tough-Track™ - Top-Loading Composite 2.43" Track	RAP-TRACK-A3U RAM® Tough-Track™ - Top-Loading Composite 3" Track	RAP-TRACK-A5U RAM® Tough-Track™ - Top-Loading Composite 5" Track	RAP-TRACK-A9U RAM® Tough-Track™ - Top-Loading Composite 9" Track
			
RAP-TRACK-A12U RAM® Tough-Track™ - Top-Loading Composite 12" Track	RAP-TRACK-A16U RAM® Tough-Track™ - Top-Loading Composite 16" Track		



SEEN IN THIS PHOTO:

RAP-TRACK-A5U

RAM® Tough-Track™ - Top-Loading Composite 5" Track

RAP-B-354U-TRA1

RAM® Track Ball™ with T-Bolt Attachment

RAP-HOL-UN7B-354-TRA1U

RAM® X-Grip® Phone Mount with RAM® Track Ball™ Base

VEHICLE MOUNTS CONTINUED

RAM® TOUGH-TRACK™

RAM® TRACK MOUNTS

RAM® Tough-Track™ mounts are easy to install with a simple clockwise turn to tighten the ball base down. Slide your mount on the track to set your desired position alongside multiple devices. Depending on the track length, you can potentially fit 2-5 devices comfortably along the track.



RAP-B-354U-TRA1
RAM® Track Ball™
with T-Bolt Attachment



RAP-354U-TRA1
RAM® Track Ball™ with T-Bolt
Attachment

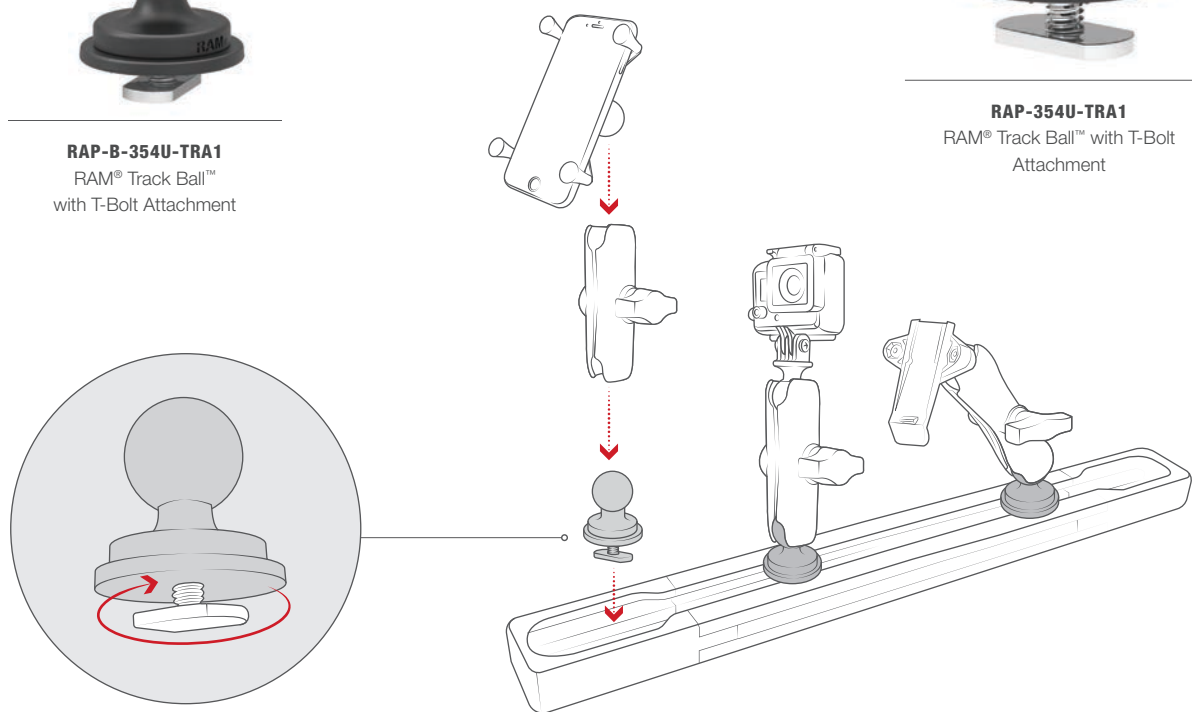

KITS



**BEST
SELLER**

RAP-HOL-UN7B-354-TRA1U
RAM® X-Grip® Phone Mount with RAM® Track
Ball™ Base



RAP-B-202-GOP1-354-TRA1U
RAM® Track Ball™ Universal Action
Camera Mount



RAP-B-202-GA76-TRA1U
RAM® Track Ball™ Double Ball Mount with
Garmin Spine Clip Holder



SEEN IN THIS PHOTO:

RAM-VB-193-SW1

RAM® No-Drill™ Laptop Mount

RAM-234K1-4U

Universal Laptop RAM® Tough-Tray™ Flat Clamping Arm Kit

FEATURES

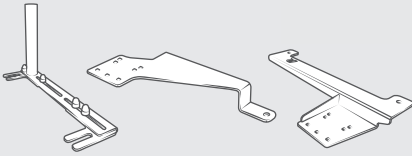

Bases available for latest vehicles including Ford, Chevy, RAM, Toyota and more

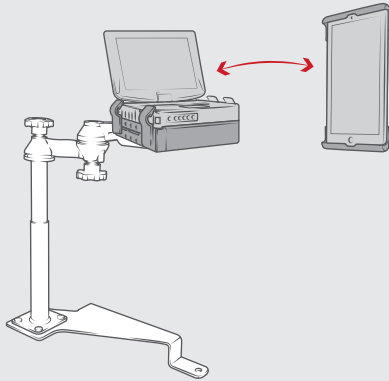

Most durable mount for any laptop or tablet



Made of powder-coated steel

VEHICLE MOUNTS CONTINUED

**FLOOR MOUNTING
RAM® NO-DRILL™**

Available for a wide variety of vehicle makes, models, and years, RAM® No-Drill™ mounts are constructed from high quality steel. Each base attaches using existing seat bolts on the passenger side and is designed to fit your specific vehicle. Create the ultimate mobile workstation with the RAM® No-Drill™ as your platform.

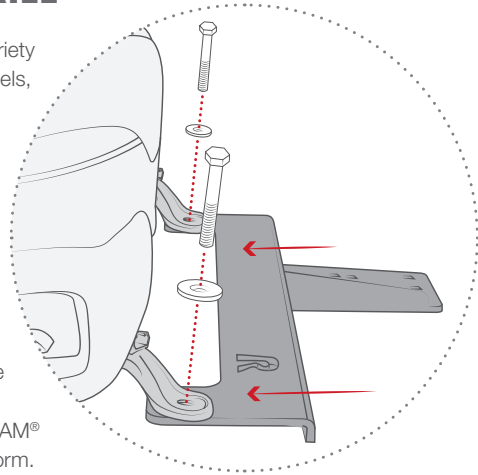

Mounts to vehicle's existing seat bolts



RAM-VB-203-SW1
RAM® No-Drill™ Laptop Mount for '19-21 Chevy Silverado + More + More



RAM-VB-203
RAM® No-Drill™ Vehicle Base for '19-21 Chevy Silverado + More



RAM-VB-195
RAM® No-Drill™ Vehicle Base for '17-20 Ford F-Series + More



RAM-VB-195-SW1
RAM® No-Drill™ Laptop Mount for '17-20 Ford F-Series + More



RAM-VB-178A-SW1
RAM® No-Drill™ Laptop Mount for '12-20 RAM 2500-5500 + More



RAM-VB-193-SW1
RAM® No-Drill™ Laptop Mount for '14-19 Chevrolet Silverado + More



RAM-VB-185-SW1
RAM® No-Drill™ Laptop Mount for '97-16 Ford F-250 - F750 + More



RAM-VB-196-SW1
RAM® No-Drill™ Universal Laptop Mount



SEE PAGE 145 FOR ALL VEHICLE COMPATIBILITY

SEEN IN THIS PHOTO:

RAM-VP-SW1-129

RAM® Tele-Pole™ with 12" & 9" Poles, Double Swing Arms & Round Plate

RAM-VPR-104-1

RAM® Spine Clip Garmin Mount with Handlebar U-Bolt Base

RAM-DIS-103-1AU

RAM® Short Accessory/Display Bracket

RAM-VB-138

RAM® No-Drill™ Vehicle Base for '05-21 Toyota 4Runner & Tacoma

RAM-HOL-TAB20U

RAM® Tab-Tite™ Holder for 9"-10.5" Tablets with Heavy Duty Cases



VEHICLE MOUNTS CONTINUED

FLOOR MOUNTING

RAM® TELE-POLE™

The RAM® Tele-Pole™ is attached to your vehicle specific base and places your device at the optimal height. Featuring sturdy powder-coated steel and anti-vibration protection, the RAM® Tele-Pole™ is offered in a variety of lengths.

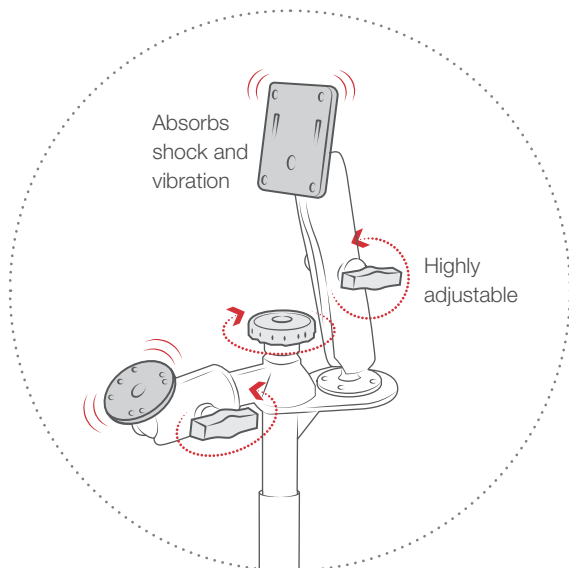

RAM-VP-SW2F-89-2461

Monitor Mount, 8" Upper Pole, 9" Lower Pole

**BEST
SELLER**



RAM-VP-SW1-89

Laptop / Tablet Mount, 8" Upper Pole, 9" Lower Pole



RAM-VP-SW1-129

Laptop / Tablet Mount, 12" Upper Pole, 9" Lower Pole



RAM-VP-SW1-1218

Laptop / Tablet Mount, 12" Upper Pole, 18" Lower Pole



RAM-VP-SW2F-89

Tablet + Keyboard Mount, 8" Upper Pole, 9" Lower Pole



RAM-VP-SW2F-8

Tablet + Keyboard Mount, 8" Upper Pole

SEEN IN THIS PHOTO:

RAM-B-166-SAM9PU

RAM® EZ-Roll'r™ Powered Suction
Cup Mount for Samsung XCover Pro



ENTERPRISE SOLUTIONS

FEATURED PRODUCTS

The RAM® Mounts ecosystem offers scalable solutions for enterprises and working individuals alike. Supporting all the latest devices, RAM® not only provides mounting solutions, but power and data transfer capabilities as well. Take advantage of the GDS® Ecosystem™ for added benefits.



MOBILE OFFICE



FIELD SERVICE



PUBLIC SAFETY



TRANSPORTATION

RUGGED TABLET



RAM-B-101-225B-SAM60P-HARU
RAM® EZ-Roll™ Powered Mount for Samsung Tab Active3 and Tab Active2 with Backing Plate



RAM-101-B-SAM52P-V7BU
RAM® Powered Mount for Samsung Tab Active Pro with Backing Plate



RAM-GDS-101B-SAM67CU
GDS® Tough-Dock™ USB Type-C Vehicle Bundle for Samsung Tab A 8.4



RAM-GDS-101LB-OMT2-SAM55U
GDS® Locking Vehicle Dock Bundle for Samsung Tab A 8.0 (2019)

RUGGED PHONE



RAM-B-166-SAM9P-2QCCIGU
RAM® Powered Suction Cup Mount for Samsung XCover Pro with Charger



RAM-B-166-PD4-2QCCIGU
RAM® Quick-Grip™ XL Type-C Vehicle Bundle



RAM-138-S-SNM1PLU
RAM® Double Ball Mount for Sonim XP5s with Speaker & Hardwire Bundle



RAM-138-S-SNM2PLU
RAM® Double Ball Mount for Sonim XP8 with Speaker & Hardwire Bundle

RUGGED LAPTOP



RAM-VB-202-A-SW1
RAM® No-Drill™ Laptop Mount for '20-21 Ford Explorer

BEST SELLER



RAM-VB-195-SW1
RAM® No-Drill™ Laptop Mount for '17-20 Ford F-Series + More



RAM-VB-203-SW1
RAM® No-Drill™ Laptop Mount for '19-21 Chevy Silverado + More



RAM-VB-196-SW1
RAM® No-Drill™ Universal Laptop Mount

RUGGED ELECTRONICS



RAM-VB-196-GDS-EC01
GDS® Ecosystem™ Vehicle Bundle with Monitor, Keyboard & Phone Mount



GDS® Ecosystem™ Vehicle Bundle for Samsung Tab Active Pro with Keyboard & Printer Mount



RAM-VPR-104-1
RAM® Quick-Draw™ Jr. with Double U-Bolt Base for Small Printers



RAM-101-400-ZE9U
RAM® Quick-Draw™ Mount for Zebra TC8000/8300 with RAM® Tough-Claw™

SEEN IN THIS PHOTO:

RAM-GDS-DOCKLF-SAM67U
Locking GDS® Cool-Dock™ for
Samsung Tab A 8.4 SM-T307



ELD MOUNTING

The ELD (Electronic Logging Device) mandate requires that every commercial truck operating on US or Canadian highways and roads must have an electronic logging device record HOS (Hours of Service). RAM® Mounts provides turnkey solutions to this mandate by offering complete bundles for ELD compliance.

SAMSUNG GALAXY TAB A 8.4 & TAB A 8.0 (2019)

Designed specifically for the Tab A 8.4 & Tab A 8.0 (2019), these bundles are all you need to become ELD compliant. Equipped with locking and non-locking features these bundles include a non-locking GDS® Tough-Dock™, IntelliSkin® Next Gen, hardwire charger, low-profile double ball mount with C size (1.5") ball & socket components, USB extension cable, backing plate adapter and two cable clamps. For added security and theft deterrence, the RAM® Pin-Lock™ socket arm is available.



RAM-GDS-101B-SAM67U
GDS® Tough-Dock™ Locking Vehicle Bundle
for Samsung Tab A 8.4



RAM-GDS-101LB-SAM55U
GDS® Tough-Dock™ Locking Vehicle Bundle for
Samsung Tab A 8.0 (2019)

SAMSUNG TAB ACTIVE3/2 & TAB ACTIVE PRO

Compatible with the Samsung Tab Active3 & 2 OEM case as well as the RAM® Skin™, this bundle was designed as a low profile and cost effective solution. For the Tab Active Pro, take advantage of the two-piece enclosure of the RAM® Tough-Case™ with a built in fan and hardwire charging components.



**BEST
SELLER**

RAM-B-101-225B-SAM60P-HARU
GDS® Tough-Dock™ Locking Vehicle Bundle for
Samsung Tab A 8.4



RAM-101B-TC-SAM54F-V7BU
RAM® Tough-Case™ with Fan Bundle for
Samsung Tab Active Pro



SEEN IN THIS PHOTO:

RAM-TC-SAM29U

RAM® Tough-Case™ with USB Type A for Samsung Tab Active3 and Tab Active2

FEATURES



7ft coiled cable keeps your device tethered in vehicle



Oversized strain relief protects cable connection



Open enclosure on front and back allows heat to flow from device.

ENTERPRISE SOLUTIONS CONTINUED

**ELD MOUNTING
RAM® TOUGH-CASE™**

The RAM® Tough-Case™ is a rugged two-piece enclosure with a built-in coiled power cable that tethers the device inside of any vehicle. This case allows you to create a hardwired connection to the tablet using a custom USB Type-C connector, with a stretch of up to 7ft which offers maximum tablet mobility while staying connected. Your connection will remain secured and protected with the use of oversized strain relief built into the RAM® Tough-Case™ making this the ideal ELD mounting solution for current Samsung tablets.

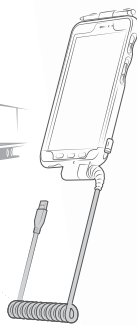

RAM-TC-SAM29U
RAM® Tough-Case™ for Samsung Tab Active3 & Tab Active2 - Type A Male USB



RAM-TC-SAM29U

RAM® Tough-Case™ with USB Type A for Samsung Tab Active3 and Tab Active2



RAM-TC-SAM29CU

RAM® Tough-Case™ with USB Type-C for Samsung Tab Active3 and Tab Active2



RAM-TC-SAM54U

RAM® Tough-Case™ for Samsung Tab Active Pro - Type A Male USB



RAM-TC-SAM50U

RAM® Tough-Case™ for Samsung Tab A 10.1, Tab A7 10.4 & Tab S6 LITE 10.4



RAM-TC-SAM67-387U

RAM® Tough-Case™ for Samsung Tab A 8.0 (2018) SM-T387



RAM-TC-SAM67-307U

RAM® Tough-Case™ for Samsung Tab A 8.4 SM-T307



RAM-TC-SAM67-290U

RAM® Tough-Case™ for Samsung Tab A 8.0 (2019) SM-T290

CHARGERS FOR USB TYPE-A



RAM-GDS-CHARGE-V7BU

GDS® Modular 8-40V Hardwire Charger with Female USB Type A Connector



RAM-GDS-CHARGE-USB2QCCIG

GDS® 2-Port USB Cigarette Charger with Qualcomm® Quick Charge™

CHARGERS FOR USB TYPE-C



RAM-GDS-CHARGE-V3FCU

GDS® Hardwire USB Type-C Power Delivery Charger with Female Connector



RAM-GDS-CHARGE-V3FCAU

GDS® Hardwire Charger with USB Type-C Female Connector & USB Type A Port



RAM-GDS-CHARGE-V3FCA2U

GDS® Hardwire Charger with USB Type-C Female & Dual USB Type A Ports



RAM-GDS-CHARGE-PPS-CIGC

GDS® Type-C and Type A 2-Port Cigarette Charger



SEEN IN THIS PHOTO:

RAM-HOL-TC-SAM29FU

RAM® Tough-Case™ Holder for Samsung Tab Active3, Tab A 8.4 & 8.0 + More with Fan



ELD MOUNTING

RAM® TOUGH-CASE™ HOLDER

To accommodate the RAM® Tough-Case™-wrapped device, an appropriate form-fit cradle snaps it into place with ports and S pen holder exposed for full access to your Samsung tablet. Equipped with a built-in fan, this holder combats high temperature environments as well as overheating. With the RAM® Tough-Case™ holder taking up minimal space, this solution is ideal for ELD mounting.

.....

FOR TAB ACTIVE3, TAB ACTIVE2, TAB A 8.0, TAB A 8.4



RAM-HOL-TC-SAM29FU

RAM® Tough-Case™ Holder for Samsung Tab Active3, Tab A 8.4 & 8.0 + More with Fan

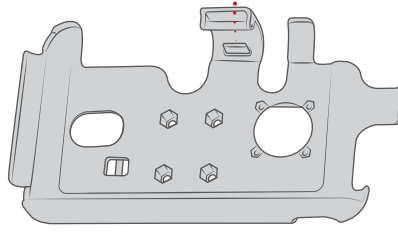

RAM-HOL-TC-SAM29U

RAM® Tough-Case™ Holder for Samsung Tab Active3, Tab A 8.4 & 8.0 + More Without fan



.....

FOR TAB ACTIVE PRO, TAB A 10.1, TAB A7 10.4 & TAB S6 LITE



RAM-HOL-TC-SAM54FU

RAM® Tough-Case™ Holder for Samsung Tab Active Pro With Fan



RAM-HOL-TC-SAM54U

RAM® Tough-Case™ Holder for Samsung Tab Active Pro Without Fan



SEEN IN THIS PHOTO:

RAM-GDS-SKIN-SAM67-NG

IntelliSkin® Next Gen for Samsung Tab A 8.4 SM-T307

RAM-GDS-DOCKL-V9-SAM67U

GDS® mUSB Vehicle Dock for Samsung Tab A 8.4 & Tab A 8.0 (2019)

RAM-GDS-HS1-RISER2U

GDS® Hand-Stand™ with Risers for Vehicle Docks

RAM-101U-B-XAT1

RAM® Universal Backing Plate Mount

INTELLISKIN® & INTELLISKIN® NEXT GEN

IntelliSkin® is a protective sleeve for phones and tablets featuring GDS® Tech™ with pogo pin technology and military-grade drop protection. With an integrated GDS® connector molded directly into each skin and ruggedized docking contacts on each skin's exterior, IntelliSkin® is designed to extend the life of devices by preventing damage to the charging port from repetitive docking. IntelliSkin® Next Gen sleeves feature flat docking contacts that are easier to clean, as well as a design that combines the hard plastic shell with soft, shock-absorbing rubber.



RAM-GDS-SKIN-SAM54-NG
IntelliSkin® Next Gen for Samsung Tab Active Pro

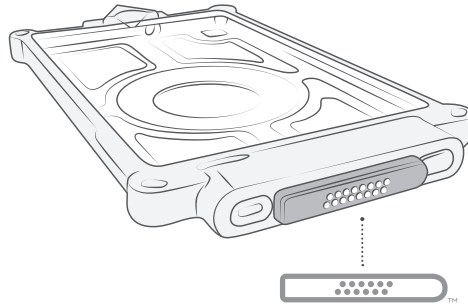

POGO PIN TECHNOLOGY
Protects your device ports from constant plugging and unplugging.

FEATURES



DROP PROTECTION
Having passed rigorous military-grade spec tests for withstanding shock and impact.



Supporting various phones and tablets including Samsung and Apple.



Secure your device and peripherals in any rugged environment; on site or on the go.



RAM-GDS-SKIN-SAM59
IntelliSkin® for Samsung Galaxy XCover Pro



RAM-GDS-SKIN-SAM67-NG
IntelliSkin® Next Gen for Samsung Tab A 8.4 SM-T307



RAM-GDS-SKIN-SAM61
IntelliSkin® for Samsung Galaxy A20



RAM-GDS-SKIN-SAM29H
IntelliSkin® for Samsung Tab Active2 SM-T390 & SM-T395



RAM-GDS-SKIN-SAM77
IntelliSkin® for Samsung Galaxy S20 FE 5G



RAM-GDS-SKIN-SAM74-NG
IntelliSkin® Next Gen for Samsung Tab Active3



SEEN IN THIS PHOTO:

RAM-SKIN-SAM29

RAM® Skin™ for Samsung Tab Active2

RAM-GDS-SS1U

GDS® Shoulder Strap Accessory for IntelliSkin® Products

RAM-GDS-HS1U

GDS® Hand-Stand™ Hand Strap and Kick Stand for Tablets

GDS® ERGO™

ACCESSORIES THAT GET THE JOB DONE

Take advantage of GDS® Ergo™ accessories like the GDS® Hand-Stand™ and shoulder strap to enable your tablet for field use. The GDS® Hand-Stand™ is a combination hand strap and kick stand that allows you to easily take your device from the warehouse to the office—and everywhere in between. With the shoulder strap accessory, quickly attach various IntelliSkin® sleeves using the snap hooks to comfortably carry your tablet.

In addition, the IntelliSkin® contact brush can be used to clean debris build-up on the GDS® contacts of IntelliSkin® sleeves. Performing routine cleaning of the GDS® contacts helps to maintain excellent performance and prevent any loss in functionality. An included adhesive pad can be attached to a variety of surfaces.

FEATURES

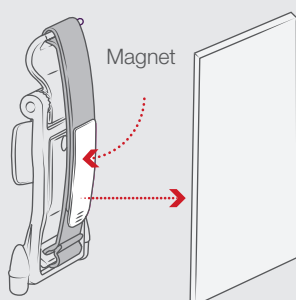

Magnetic GDS® Hand-Stand™ connects to any ferro-magnetic surface

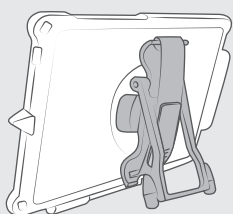

GDS® Hand-Stand™ compatible with most IntelliSkin® wrapped tablets

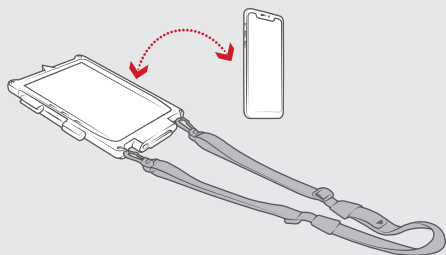

Shoulder strap compatible with most IntelliSkin® wrapped phones & tablets



BEST SELLER

RAM-GDS-HS1U

GDS® Hand-Stand™ Hand Strap and Kick Stand for Tablets

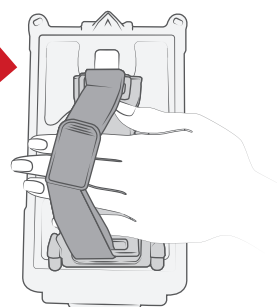

Enhances comfort and convenient for any phone or tablet on the go



RAM-GDS-HS1MU

GDS® Hand-Stand™ Magnetic Hand Strap and Kick Stand for Tablets



RAM-GDS-SS1U

GDS® Shoulder Strap Accessory for IntelliSkin® Products



SEEN IN THIS PHOTO:

RAM-GDS-SKIN-SAM54-NG

IntelliSkin® Next Gen for Samsung
Tab Active Pro

RAM-GDS-DOCKL-V9-OMT1U

GDS® Type-C Vehicle Dock for
IntelliSkin® Next Gen Tablets

RAM-VB-195-SW2

RAM® No-Drill™ Mount for
'17-21 Ford F-250 - F-550 + More

FEATURES

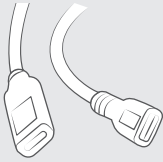

mUSB and USB Type-C docks provide fast charging

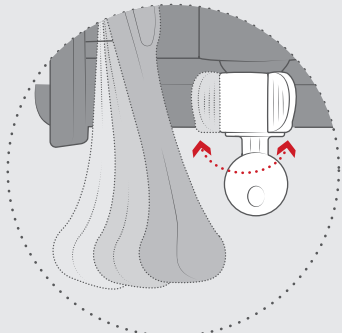

Key locking

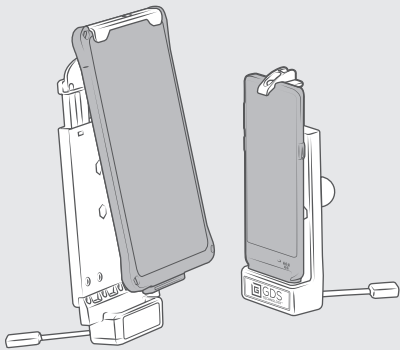

Compatible with any IntelliSkin®-wrapped phone or tablet

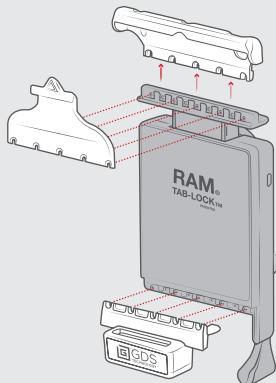

Interchangeable docking cups

ENTERPRISE SOLUTIONS CONTINUED

GDS® VEHICLE DOCKS™

GDS® vehicle docks with GDS® Technology™ offer a universal charging platform for any device wrapped in an IntelliSkin® sleeve. IntelliSkin® offers drop protection and uses ruggedized external contacts to allow for repetitive docking, with no need to deal with charging cables.



BEST SELLER

RAM-GDS-DOCKL-V9-OMT1U
GDS® Type-C Vehicle Dock for IntelliSkin® Next Gen Tablets

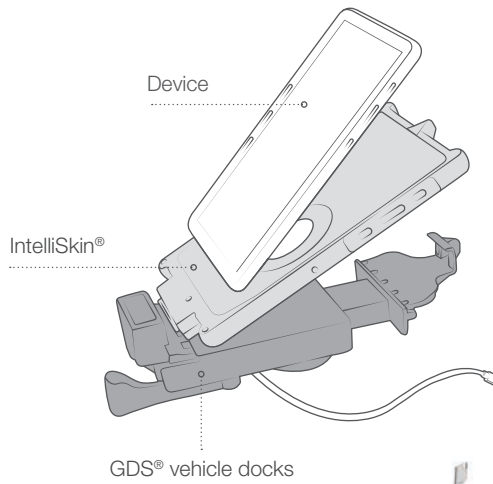

RAM-GDS-DOCK-V1CU
GDS® Vehicle Phone Dock with USB Type-C for IntelliSkin® Products



RAM-GDS-DOCKL-V3CU
Locking Vehicle Phone Dock



RAM-GDS-DOCKL-V2-SAM21U
GDS® Locking Vehicle Dock for Samsung Tab E 8.0



RAM-GDS-DOCKL-V2-AP23U
GDS® Locking Vehicle Dock for Apple iPad Pro 11"

SEEN IN THIS PHOTO:

RAM-GDS-DOCKL-V9-OMT1U

GDS® Type-C Vehicle Dock for IntelliSkin® Next Gen Tablets

RAM-GDS-SKIN-SAM54-NG

IntelliSkin® Next Gen for Samsung Tab Active Pro

RAM-VB-195-SW2

RAM® No-Drill™ Mount for '17-21 Ford F-250 - F-550 + More





ENTERPRISE SOLUTIONS CONTINUED

GDS® VEHICLE DOCKS™ FUTURE PROOF

The modularity of GDS® vehicle docks provide the highest quality and most cost-effective solutions for your tablet, including future device upgrades. The GDS® Ecosystem™ and universal GDS® pogo pins provide compatibility across multiple devices.

Upgrade your GDS® Vehicle Dock Cup to support IntelliSkin® Next Gen

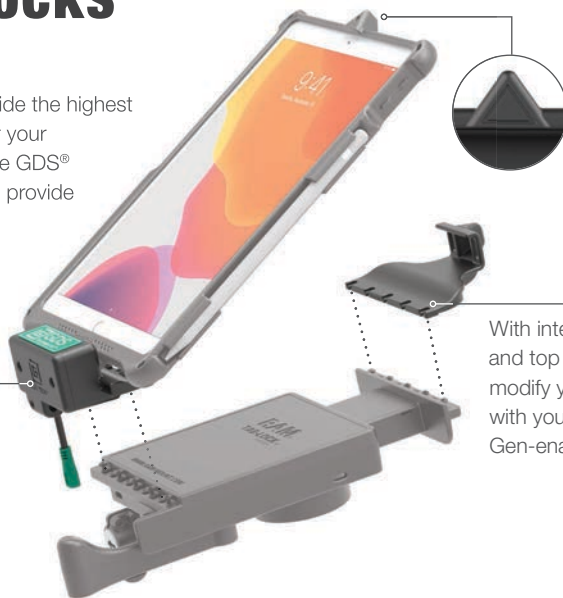

Product positioning marker provides universal compatibility across IntelliSkin® Next Gen sleeves and GDS® top cups

With interchangeable dock cups and top cups, you can easily modify your existing dock to work with your new IntelliSkin® Next Gen-enabled device



RAM-GDS-DOCK-V10PU
GDS® Powered Dock Cup for IntelliSkin® Next Gen Tablets



RAM-GDS-DOCK-V10PDU
GDS® Power + Data Dock Cup for IntelliSkin® Next Gen Tablets

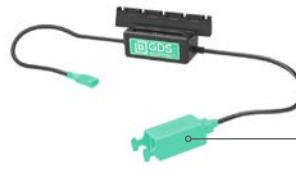

RAM-GDS-DOCK-V10PD2U
GDS® Power + Dual USB Data Dock Cup for IntelliSkin® Next Gen Tablets



SEEN IN THIS PHOTO:

RAM-GDS-SKIN-SAM54-NG

IntelliSkin® Next Gen for Samsung
Tab Active Pro

RAM-GDS-DOCKLF-SAM54CU

Locking GDS® Cool-Dock™ with USB Type-C for Samsung Tab Active Pro

RAM-VB-195-SW2

RAM® No-Drill™ Mount for '17-21 Ford F-250 - F-550 + More

GDS® VEHICLE DOCKS™

GDS® TOUGH-DOCK™ & GDS® COOL-DOCK™

The GDS® Tough-Dock™ and GDS® Cool-Dock™ are the newest vehicle docks in the GDS® Tech™ line of vehicle docks designed to support select Samsung Galaxy tablets in a IntelliSkin® Next Gen protective sleeve for your fleet. Take advantage of a USB Type-C connector, supporting data sync and fast charging capabilities.



RAM-GDS-DOCKLF-SAM67U

Locking GDS® Cool-Dock™ for Samsung Tab A 8.4 SM-T307

FEATURES

1		<p>LOCKING & NON-LOCKING</p> <p>Secure your device for theft deterrence with a key locking option available for all GDS® Tough-Dock™ and GDS® Cool-Dock™ models.</p>
2		<p>GDS® HAND-STAND™ COMPATIBLE</p> <p>The GDS® Tough-Dock™ and GDS® Cool-Dock™ have integrated space for GDS® Hand-Stand™ attachments on the back of your IntelliSkin® Next Gen-wrapped device.</p>
3		<p>BUILT-IN FAN</p> <p>12-VDC Axial cooling fan with 2.2m long long hardwire cable and SAE quick disconnect plugs available as an upgrade, or standard with all GDS® Cool-Dock™ models.</p>
4		<p>STANDARD & HIGH SPEED POWER OPTIONS</p> <p>All GDS® Tough-Dock™ and GDS® Cool-Dock™ models are available and support both mUSB and USB Type-C connections.</p>
5		<p>CONNECT YOUR KEYBOARD & OTHER PERIPHERALS</p> <p>Customize your mobile workstation with peripheral add-ons that help improve your workflow. Our GDS® Ecosystem™ makes it easy to choose different peripherals designed to work perfectly with the GDS® Tough-Dock™ and GDS® Cool-Dock™.</p>



SEEN IN THIS PHOTO:

RAM-VP-SW2F-45-2461

RAM® Tele-Pole™ with 4" & 5" Poles and Double Ball
75x75mm VESA Mount

RAM-KB2-USB

GDS® Keyboard™ available with and without trackpad

RAM-GDS-DOCK-V1CU

GDS® Vehicle Phone Dock for phones with IntelliSkin®

RAM-GDS-SKIN-SAM28

IntelliSkin® for Samsung S8

RAM-DIS-103-1AU

RAM® Standard Accessory/Display Bracket

RAM-B-138U-A

RAM® Double Ball Drill-Down Mount with Diamond Plate

GDS® VIEW™

EXPAND THE CAPABILITIES OF YOUR WORKSTATION

The GDS® View™ 13.3" touchscreen monitor lets you take the PC experience on the road. Featuring VESA hole patterns compatible with the RAM-2461U and RAM-D-2461U mounting plates, create a mobile workstation that takes advantage of the GDS® Ecosystem™ for data sync and charging capabilities. The GDS® View™ monitor has undergone MIL-STD-810G 514.5 vibration and MIL-STD810G 516.5 shock testing, ensuring performance in the most demanding environments. This two-point capacitive touchscreen monitor allows you to pinch, zoom, and select—and includes an anti-glare and anti-fingerprint treatment. Control buttons on the front of the monitor are easy to access, while a red monochrome night mode helps to reduce eyestrain. In addition, two integrated 2W speakers allow for audio. Includes HDMI, VGA, and USB Type-B to USB Type-A cables.



RAM-GDS-MON-13-1
GDS® View™ 13.3"
Touch Screen Monitor

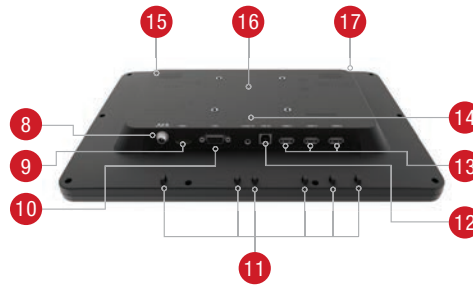
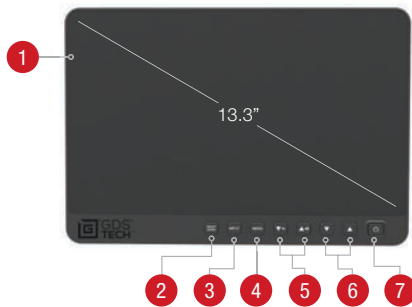

FEATURES	
1 AMBIENT LIGHT SENSOR	10 VGA 
2 NIGHT MODE (ON/OFF)	11 CABLE TIE-DOWNS
3 INPUT SELECTION (HDMI, PC)	12 USB TYPE-B (Host input) 
4 MENU (on screen display)	13 USB TYPE-A 
5 VOLUME UP/DOWN (or navigate in menu)	14 AUDIO IN 
6 VOLUME UP/DOWN (or navigate in menu)	15 SPEAKER (Left)
7 POWER (ON/OFF)	16 VESA 75 MOUNTING (#10-24 Thread)
8 POWER (10-30V DC) 	17 SPEAKER (Right)
9 HDMI 	

RAM-GDS-DOCK-V1CU
GDS® Vehicle Phone Dock for phones with IntelliSkin®



RAM-KB2-USB
GDS® Keyboard™ available with and without trackpad

RAM-VP-SW2F-45-2461
RAM-VB-202
(FOR '19-'20 FORD RANGER & 2020 EXPLORER)
RAM® No-Drill™ Vehicle Base with RAM® Tele-Pole™ and swing arm system

SEEN IN THIS PHOTO:

RAM-KB2-USB

GDS® Keyboard™ with Track Pad

RAM-GDS-SKIN-AP24-A

IntelliSkin® for the Apple iPad Pro 12.9" 4th Gen

RAM-GDS-DOCKL-V2-AP24U

GDS® Locking Vehicle Dock for Apple iPad Pro 12.9" 3rd & 4th Gen

RAM-DIS-103-1AU

RAM® Standard Accessory/Display Bracket

RAM-VB-196-SW2

RAM® No-Drill™ Universal Vehicle Floor Mount

RAM-GDS-SS1U

GDS® Shoulder Strap Accessory for IntelliSkin® Products



GDS® KEYBOARD™

RUGGED AND DURABLE KEYBOARD SOLUTION

Featuring AMPS and VESA hole patterns for attachment to a variety of brackets, these rugged GDS® keyboard solutions are RAM® Mounts Compatible™. With the RAM® Tab-Tite™ and RAM® Tab-Lock™ holders, easily secure either wired keyboard into place for use in vehicles and other mobile workstations. Choose between two keyboard versions: one featuring a 10-key numeric pad and the other featuring a track pad.



**BEST
SELLER**

RAM-KB2-USB
GDS® Keyboard™ with Track Pad



RAM-KB4-USB
GDS® Keyboard™ with 10-Key
Numeric Pad

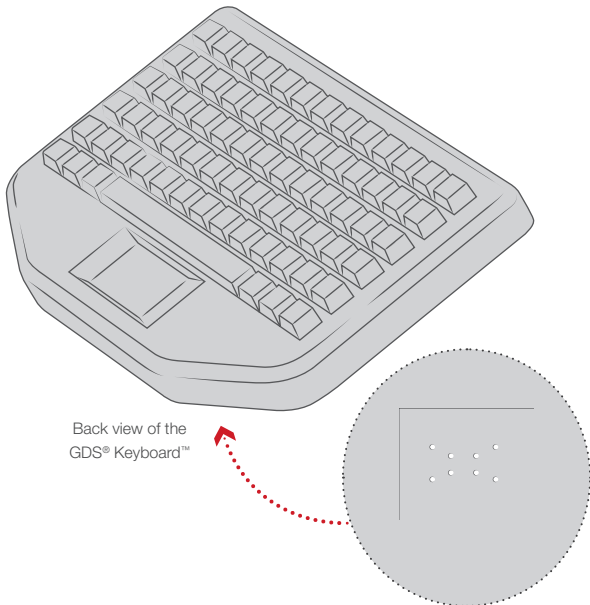

Back view of the
GDS® Keyboard™

AMPS & VESA
hole patterns for
any RAM® Mount



RAM-HOL-TAB-KBU
RAM® Tab-Tite™ Holder for
GDS® Keyboard™



RAM-HOL-TABL-KBU
RAM® Tab-Lock™ Locking Holder for
GDS® Keyboard™

FEATURES



Track pad & 10-Key
options available

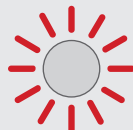

Backlit with red illumination to
reduce eyestrain at night



IP65 rated to protect
against dust and spills

SEEN IN THIS PHOTO:

RAM-SPEAK-A02

GDS® Audio™ Amplified Speaker with PTT Breakout Feature

RAM-GDS-101LB-OMT2-SAM67U

GDS® Locking Vehicle Dock Bundle for Samsung Tab A 8.4

RAM-101-MIC1U

RAM® Short Bracket Adapter for Speakers & Microphones



SEEN IN THIS PHOTO:

RAM-101B-225B-SAM60PD-AUD-V7BU

RAM® Powered Mount for Samsung Tab Active3 and Tab Active2 with Speaker

RAM-GDS-SS1U

GDS® Shoulder Strap Accessory for IntelliSkin® Products



GDS® AUDIO™

AMPLIFIED AUDIO ON THE GO

This amplified wired speaker can be efficiently adjusted to an ideal position, and includes a knob to quickly change the volume. The speaker is RAM® Mounts Compatible™—making it easy to secure wherever it's needed.



RAM-SPEAK-A01
GDS® Audio™ Amplified Speaker

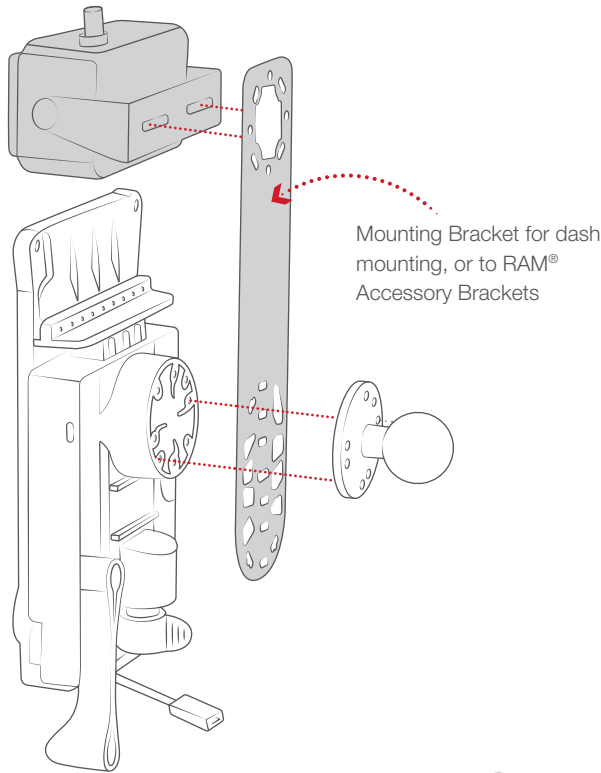

RAM-SPEAK-A02
GDS® Audio™ Amplified Speaker with PTT Breakout Feature



RAM-101-MIC1U
RAM® Short Bracket Adapter for Speakers & Microphones



RAM-101-MIC2U
RAM® Standard Bracket Adapter for Speakers & Microphones

FEATURES

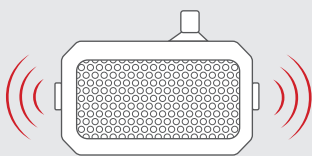

8Ω / 10W rated speaker

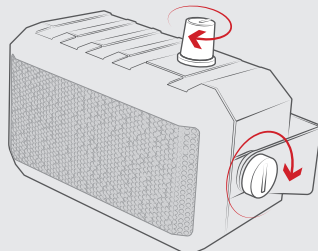

Independently adjustable volume knob

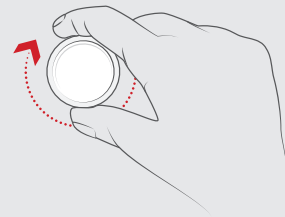

Max volume range: 93dB

GDS® TOUGH-HUB™

EXPAND YOUR WORKFLOW

With the GDS® Tough-Hub™, keep a wide range of devices, docks, and peripherals charged and connected in nearly any vehicle. Each GDS® Tough-Hub™ includes numerous ports—USB, HDMI, RJ45, and more.

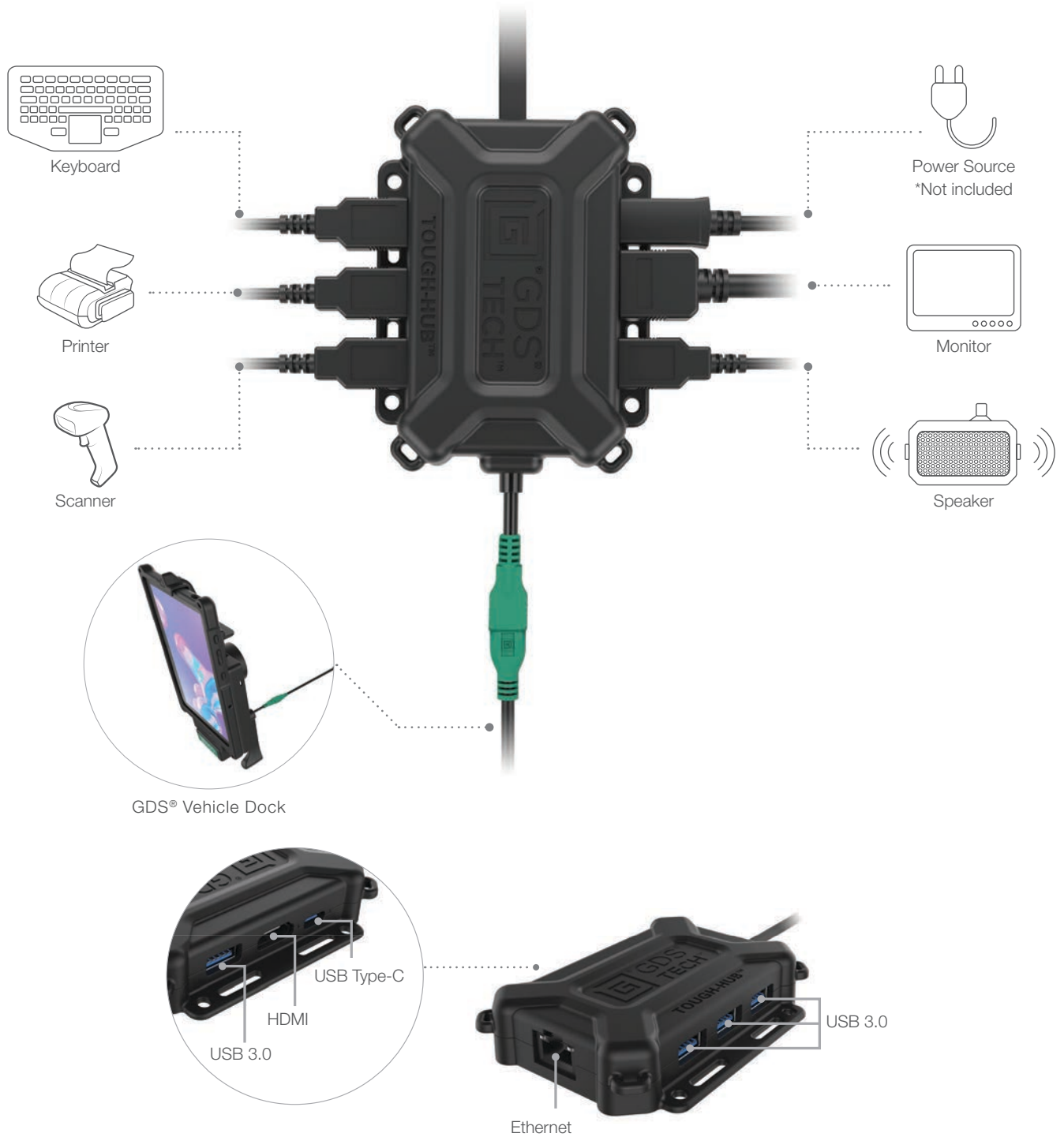

RAM-GDS-HUB-TYPEC-01

GDS® Tough-Hub™ with USB Type-C for Vehicles

GDS® ECOSYSTEM™

The GDS® Ecosystem™ offers everything to keep your devices protected, connected, and charged in nearly any application. Ruggedized GDS® Technology™ pogo pins ensure compatibility across IntelliSkin® sleeves, GDS® Docks™, adapters, chargers, keyboards, speakers, monitors, and more. Most products in the GDS® Ecosystem™ are RAM® Mounts Compatible™, so you can rely on the RAM® double ball and socket system for adjustability, durability, and vibration damping.

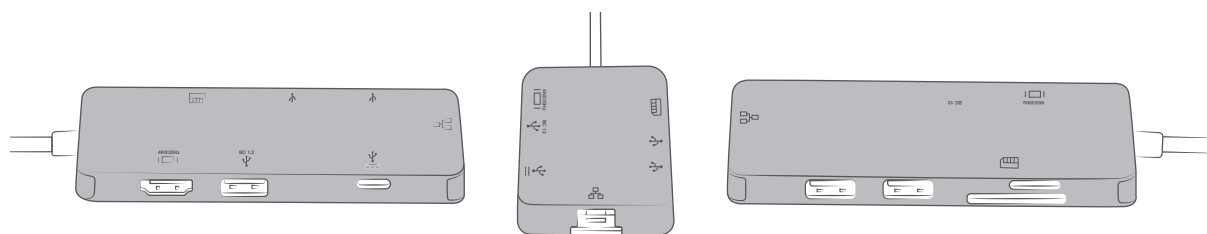
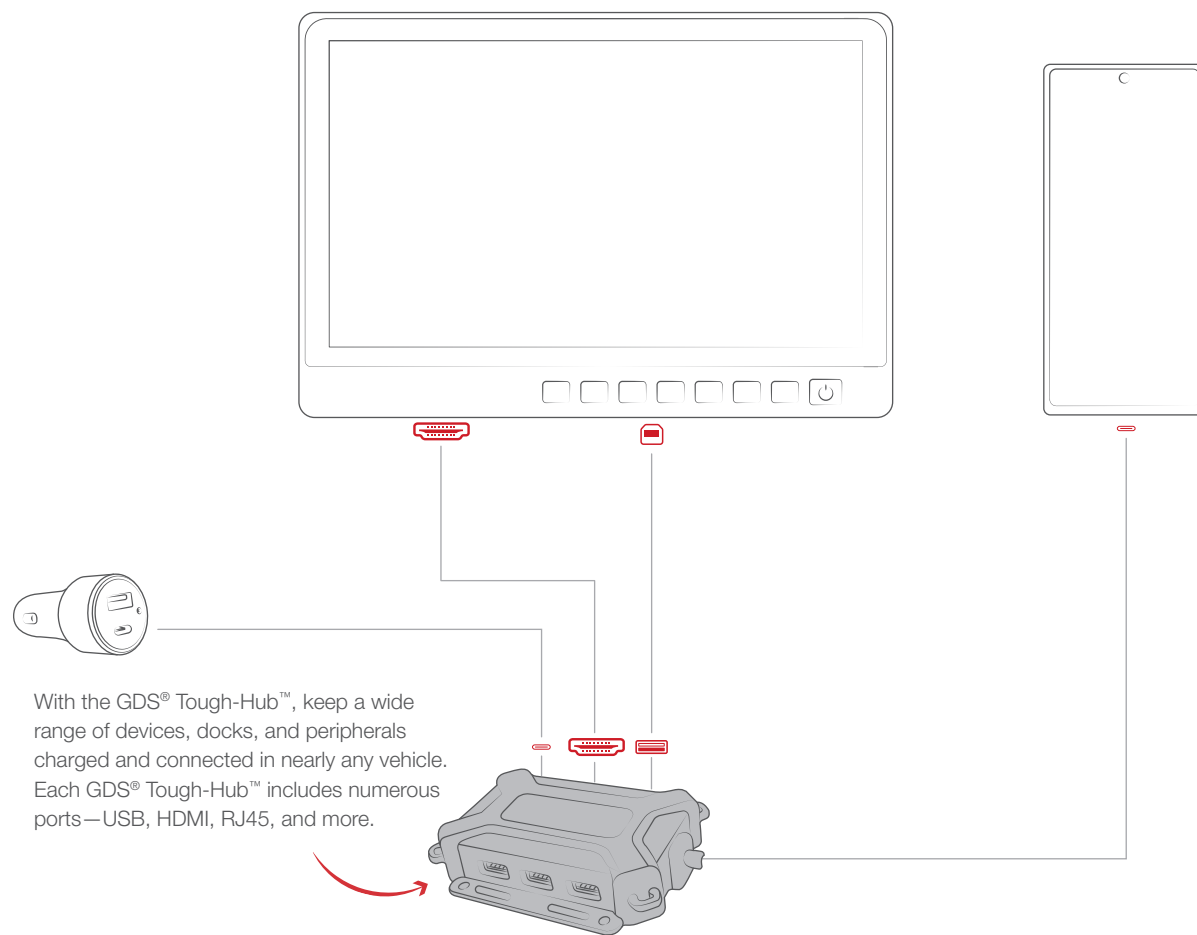

RAM-GDS-HUB-TYPEC-02
GDS® Hub™ With USB Type-C For Desktop

GDS® CHARGE™

CHARGERS FOR ANY SITUATION

A wide variety of GDS® Charge™ accessories help to power GDS® devices and docks. Choose from cigarette, hardwire, and wall chargers for a variety of USB types. See the list below to find the charger that's compatible with your device.

WALL AND VEHICLE CHARGERS

PART NUMBER	CHARGER TYPE	INPUT RANGE	OUTPUT	OUTPUT CONNECTOR TYPE	COMPATIBLE DEVICES
RAM-GDS-CHARGE-USB2QCCIG	2 port cig charger with Quick Charge support	12-18VDC	Port 1: Quick Charge 3.0(18W) Port 2: 36W Max 5V/2.4A (12W)	2 Qty USB-A Female	Any 5V/9V device with a current requirement of 2.4A or less. Includes support of Apple iOS 2.1/2.4A devices and support for Qualcomm® Quick Charge™ 2.0/3.0 devices
RAM-GDS-CHARGE-V7BU	USB Type-A hardwire	8-40VDC	5VDC & 9VDC (QC only) 2.5A Max	.2M cable with USB-A Female	Any 5V/9V device with a current requirement of 2.5A or less. Includes support of Apple iOS 2.1/2.4A devices and support for Qualcomm® Quick Charge™ 2.0/3.0 devices
RAM-GDS-CHARGE-V7-M55U	DC cable hardwire	8-40VDC	5VDC 2.5A Max	1.2M cable with DC plug	Any 5V device with a current requirement of 2.5A or less
RAM-GDS-CHARGE-V7-MUSBU	mUSB hardwire	8-40VDC	5VDC & 9VDC (QC only) 2.5A Max	1.2M cable with Micro-B USB Male	Any 5V/9V device with a current requirement of 2.5A or less. Includes support of Apple iOS 2.1/2.4A devices and support for Qualcomm® Quick Charge™ 2.0/3.0 devices
RAM-GDS-CHARGE-USBCU	USB Type-C hardwire	8-40VDC	5VDC & 9VDC (QC only) 2.5A Max	1.2M cable with USB-C Male	Any 5V/9V device with a current requirement of 2.5A or less. Includes support of Apple iOS 2.1/2.4A devices and support for Qualcomm® Quick Charge™ 2.0/3.0 devices
RAM-GDS-CHARGE-USB6	6 port charger	100-240V 50/60Hz	5V/2.4A Per Port (Max) 60W Max, 12A	6 Qty USB-A Female	Any 5V device with a current requirement of 2.4A or less
RAM-GDS-CHARGE-V3CU	USB Type-C hardwire	12-24VDC	5V/3A; 9V/3A; 12V/3A; 15V/2.5A 37.5W Max	1 M cable with USB-C Male	Any device supporting Power Delivery 2.0 up to 36W
RAM-GDS-CHARGE-USBCW	GDS® Type-C 18W Mini Wall Charger	100-240V 50/60Hz	Type C/QC 3.0 Output: 5V/3A, 9V/2A 18W 12V/1.5A	Type-C Female	Devices supporting USB 3.1 Power Delivery 3.0 and Qualcomm Quick Charge 3.0 up to 15V/1.2A
RAM-GDS-CHARGE-USBC2W	GDS® Type-C and Type-A 48W Premium 2-Port Wall Charger	100V-240V 50/60Hz	USB-A Output : 5V/3A, 9V/2A, 12V/1.5A USB-C Output: 5V/3A, 9V/3A, 15V/2A, 20V/1.5A 48W Total	1 QTY Type-C Female (Power Delivery) & 1 QTY Type-A Female (QC 3.0)	USB-C: Devices supporting USB 3.1 Power Delivery 3.0 up to 20V/1.5A Type-A: Any 5V/9V device with a current requirement of 2.5A or less
RAM-GDS-CHARGE-PPS-CIGC	GDS® Type-C and Type A 2-Port Cigarette Charger	12-24V DC	USB-C Output: 5V/3A; 9V/3A; 12V/2.5A; 15V/2A; 20V/1.5A USB-A Output: 5V/3A; 9V/2A; 12V/1.5A	1 QTY Type-C Female (Power Delivery) & 1 QTY Type-A Female (QC 3.0)	USB-C: Devices supporting USB 3.1 Power Delivery 3.0 up to 20V/2A. Type-A: Any 5V/9V device with a current requirement of 2.5A or less
RAM-GDS-CHARGE-V3CAU	GDS® Hardwire Charger with USB Type C Male Connector and USB Type A Port for peripherals	12-24V DC	5V/3A; 9V/3A; 12V/3A; 15V/2.5A 37.5W Max	Male Type-C with Female Type-A for peripheral support	Supports any USB-C Device that uses the USB 3.1 PD2.0 standard or higher, with max power up to 36W (5V/3A, 9V/3A, 12V/3A, 15V/2.5A)

USB CABLES

PART NUMBER	LENGTH	CABLE TYPE
RAM-GDS-CAB-MUSB2-1	1.2 Meters	USB Type-A male to mUSB 2.0 male
RAM-GDS-CAB-MUSB290-1	1.2 Meters	USB Type-A male to 90-Degree mUSB 2.0 male
RAM-GDS-CAB-USBC-AMCMU	1 Meter	USB Type-A male to USB Type C 3.0 male
RAM-GDS-CAB-MUSB3-1	1.2 Meters	USB Type-A male to mUSB 3.0 male
RAM-GDS-CAB-USBA-DC90-1U	1 Meter	USB Type-A male to 5.5mm DC Connector
RAM-GDS-CAB-USBC-CMCMU	0.5 Meter	USB Type-C 3.1 Gen 1 male to USB Type-C 3.1 Gen 1 male

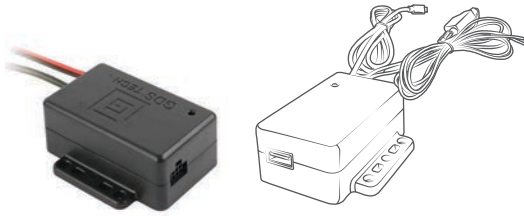

RAM-GDS-CHARGE-RS232U
GDS® Hardwire Charger with mUSB Plug and Serial adapter

INPUT

 **6 PIN MOLEX**
Female with DB 9 Cable

 **HARDWIRE POWER SUPPLY**
Built-in

OUTPUT

 **USB MICRO-B**
Male

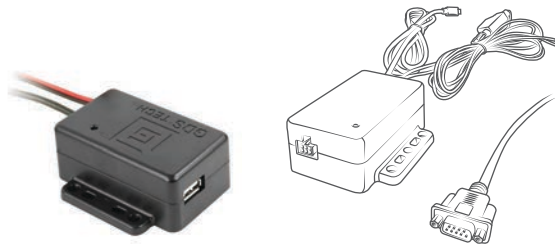

RAM-GDS-CHARGE-OTGAU
GDS® Hardwire Charger with mUSB Plug and type-A PORT

INPUT

 **USB TYPE-A**
Female

 **HARDWIRE POWER SUPPLY**
Built-in

OUTPUT

 **USB MICRO-B**
Male

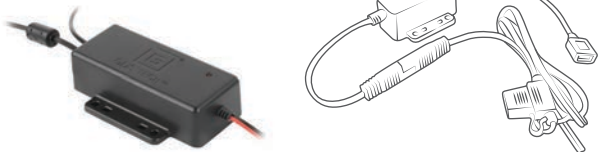

RAM-GDS-CHARGE-V3CAU
GDS® Hardwire Charger with USB type-C PLUG

INPUT

 **USB TYPE-A**
Female

 **HARDWIRE POWER SUPPLY**
Built-in

OUTPUT

 **USB TYPE-C POWER DELIVERY**
Male

SEEN IN THIS PHOTO:

RAM-SKIN-SAM52

RAM® Skin™ for Samsung Tab Active Pro

RAM-GDS-HS1U

GDS® Hand-Stand™ Hand Strap and Kick Stand for Tablets



SEEN IN THIS PHOTO:

RAM-SKIN-SAM73

RAM® Skin™ for Samsung Tab Active3

RAM-GDS-HS1U

GDS® Shoulder Strap Accessory for IntelliSkin® Products



ENTERPRISE SOLUTIONS CONTINUED

RAM® SKIN™

This RAM® Skin™ was designed specifically for the Samsung Tab Active Pro, Tab Active3 and Tab Active2. It features MIL-STD-810G military-grade drop protection and a built-in S Pen holder. Made for rugged use in a variety of applications, the RAM® Skin™ is ideally paired with the GDS® Hand-Stand™ tablet hand strap and kickstand as well as the GDS® shoulder strap accessory.

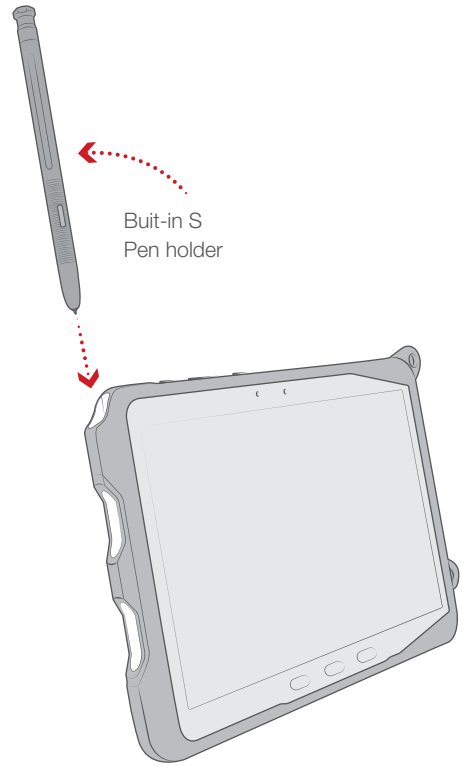

RAM-SKIN-SAM29
RAM® Skin™ for Samsung Tab Active2



RAM-SKIN-SAM52
RAM® Skin™ for Samsung Tab Active Pro



RAM-SKIN-SAM73
RAM® Skin™ for Samsung Tab Active3



RAM-GDS-SS1U
GDS® Shoulder Strap Accessory for IntelliSkin® Products



BEST SELLER

RAM-GDS-HS1U
GDS® Hand-Stand™ Hand Strap and Kick Stand for Tablets



RAM-GDS-HS1MU
GDS® Hand-Stand™ Magnetic Hand Strap and Kick Stand for Tablets

FEATURES



Compatible with GDS® Ergo™ accessories

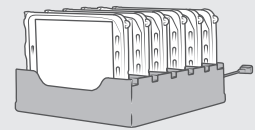
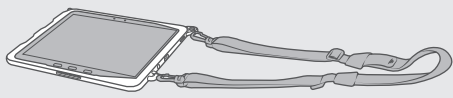

Compatible with a range of feature-rich RAM® docks

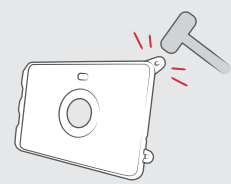

Made of durable polycarbonate and thermoplastic elastomers

Supports factory OEM skin and RAM® Skin™

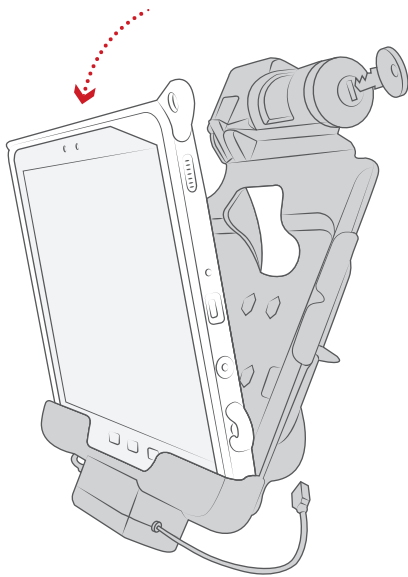

ENTERPRISE SOLUTIONS CONTINUED

FORM-FIT HOLDERS

For a slim, clean mounting solution, the form-fit holders offer a custom housing that fits perfectly for select Samsung devices in its original OEM skin or the RAM® Skin™. Numerous add-ons and options include combination locks, key locks, dual USB and power-only docks.



RAM-101B-225B-SAM60PD-AUD-V7BU
RAM® Powered Mount for Samsung Tab Active3 and Tab Active2 with Speaker



RAM-HOL-SAM57PKLU
RAM® Skin™ Key-Locking Powered Dock for Samsung Tab Active Pro



RAM-HOL-SAM60PU
RAM® EZ-Roll'r™ Powered Dock for Samsung Tab Active3 and Tab Active2



RAM-HOL-SAM58PD2CLU
RAM® Skin™ Combo-Locking Powered Dock for Samsung Tab Active3/2

BEST SELLER

AVAILABLE IN:



KEY LOCK



COMBO LOCK



NON-LOCKING



POWER



POWER + DATA

FEATURES

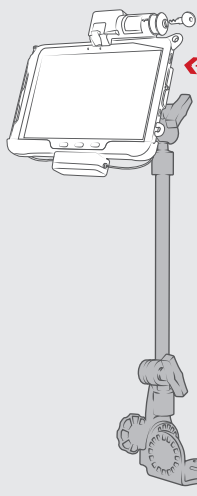

Back of Form-Fit Holder, showing the AMPS hole patterns

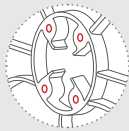

AMPS hole pattern connects to any RAM® vehicle mounts

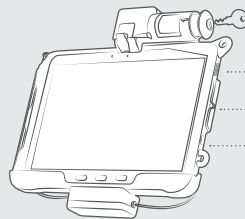

Speakers, mics and headphone jack remain exposed

1

Speakers

2

Mics

3

Headphone Jack

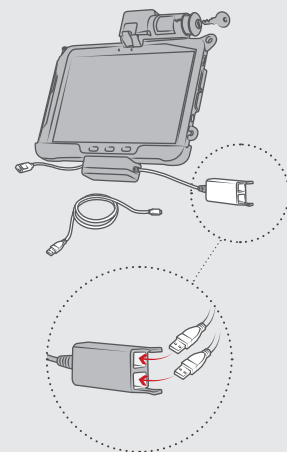

Keeps your tablet charged, protected and connected to your peripherals



SEEN IN THIS PHOTO:

RAM-HOL-SAM57PD2KLU
 RAM® Skin™ Key-Locking
 Power + Dual USB Data
 Cradle for Tab Active Pro

TAB ACTIVE2 & TAB ACTIVE3					
PART NUMBER	⚡ POWER	🔒 KEY LOCKING	🔒 COMBO LOCKING	⚡ SINGLE USB PERIPHERAL	⚡🔌 DUAL USB PERIPHERAL
RAM-HOL-SAM60PU	•				
RAM-HOL-SAM60PDU	•			•	
RAM-HOL-SAM60PD2U	•				•
RAM-HOL-SAM58PKLU	•	•			
RAM-HOL-SAM58PDKLU	•	•		•	
RAM-HOL-SAM58PD2KLU	•	•			•
RAM-HOL-SAM58PCLU	•		•		
RAM-HOL-SAM58PDCLU	•		•	•	
RAM-HOL-SAM58PD2CLU	•		•		•

TAB ACTIVE PRO					
PART NUMBER	⚡ POWER	🔒 KEY LOCKING	🔒 COMBO LOCKING	⚡ SINGLE USB PERIPHERAL	⚡🔌 DUAL USB PERIPHERAL
RAM-HOL-SAM52PU	•				
RAM-HOL-SAM52PDU	•			•	
RAM-HOL-SAM52PD2U	•				•
RAM-HOL-SAM57PKLU	•	•			
RAM-HOL-SAM57PCLU	•		•		
RAM-HOL-SAM57PDCLU	•		•	•	
RAM-HOL-SAM57PD2CLU	•		•		•
RAM-HOL-SAM57PDKLU	•	•		•	
RAM-HOL-SAM57PD2KLU	•	•			•



SEEN IN THIS PHOTO:

RAM-HOL-SAM59U

RAM® EZ-Roll'r™ Cradle

RAM-B-238U

RAM® Diamond Ball Base

RAM-B-201U-C

RAM® Double Socket Arm

RAP-B-400U

RAM® Tough-Claw™ Small
Clamp Base with Ball



FEATURES

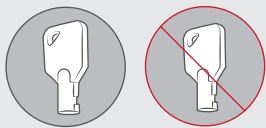

Locking & non-locking options available

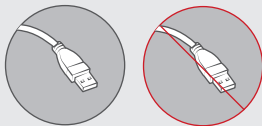

Powered & non-powered options available

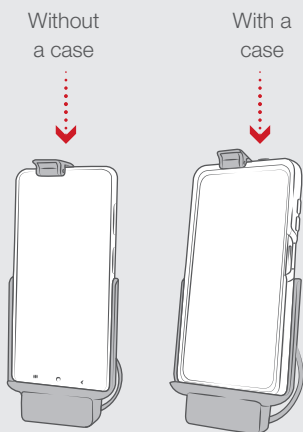

Solutions for XCover Pro with and without a case

ENTERPRISE SOLUTIONS CONTINUED

SAMSUNG XCOVER PRO

The Samsung XCover Pro takes some of the best features of current Tab Active tablets by introducing the pogo-pad technology for charging purposes. RAM® supports these kinds of innovations with pogo-pin enabled powered docks. Of course, with a non-powered option available, the RAM® EZ-Roll'r™ system supports the Samsung XCover Pro without a case as well as an option for OtterBox uniVERSE-wrapped XCover Pros. Simply drop the device into the powered docks and the aligned pogo-pins to pogo-pads instantly starts charging.

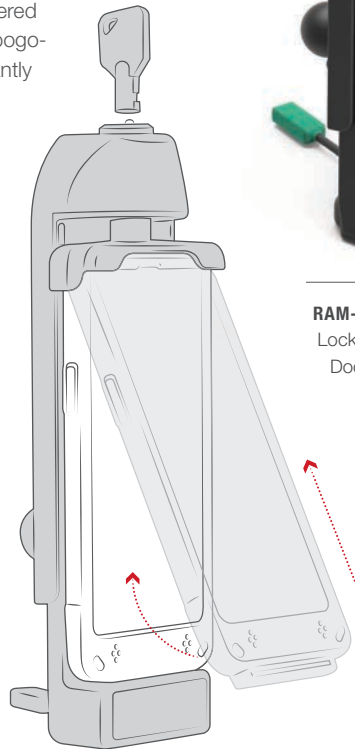

Compatible with all RAM® phone mounts



RAM-GDS-DOCKL-V3CU
Locking Vehicle Phone Dock for IntelliSkin®



RAM-HOL-SAM59U
Non-Powered RAM® EZ-Roll'r™



RAM-HOL-SAM9P-OT2U
Powered RAM® EZ-Roll'r™ with OtterBox uniVERSE

BEST SELLER



RAM-HOL-SAM9PU
Powered RAM® EZ-Roll'r™



RAM-GDS-SKIN-SAM59
IntelliSkin®



SEEN IN THIS PHOTO:

RAM-VB-196-GDS-EC01

GDS® Ecosystem™ Vehicle Bundle with
Monitor, Keyboard & Phone Mount

SAMSUNG DEX IN-VEHICLE

RAM® Mounts has partnered with Samsung to support the Samsung DeX platform by enabling the system in-vehicle. Samsung DeX allows you to consolidate your workflow through a Samsung phone while RAM® Mounts allows you to transform your vehicle into a mobile workstation with the help of familiar peripherals that emulate a desktop experience.

The GDS® Ecosystem™ Bundle is the all-in-one solution for introducing Samsung DeX into your workflow. This bundle includes a GDS® View™ 13.3" touchscreen monitor, a GDS® Keyboard™, display bracket, universal vehicle mount, phone mount, and hardware chargers to transform your vehicle into a mobile office. Simply insert your DeX-enabled Samsung phone and connect your device to the workstation so you can work on the go.

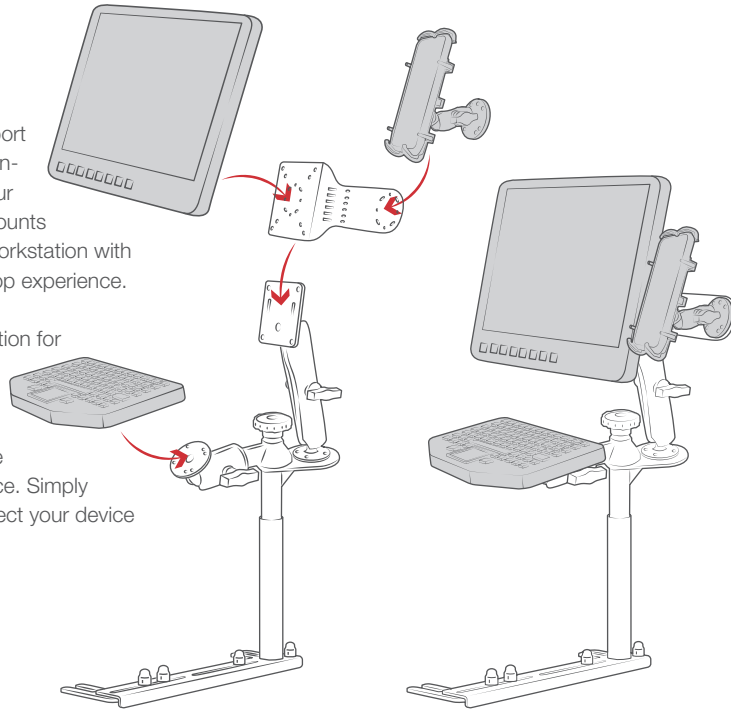

RAM-VB-196-GDS-EC01

GDS® Ecosystem™ Vehicle Bundle with Monitor, Keyboard & Phone Mount



SEEN IN THIS PHOTO:

RAM-HOL-ZE7U

RAM® Form-Fit Powered Holder for Zebra TC70, 72, 75 & 77

RAM-316-HD-18-202U

RAM® Pod HD™ Vehicle Mount with 18" Aluminum Rod and Round Plate



ZEBRA

RAM® Mounts offers a wide variety of ruggedized mounting solutions for Zebra mobile computers, printers, barcode scanners and more. Utilizing our form-fitting cradle design, securing your device wherever you need it has never been easier. The versatility of RAM® systems allow you to efficiently move your device between your car, desk, forklift, and much more. Allowing for near-infinite adjustability as well as vibration damping, the RAM® double ball and socket system provides maximum versatility and helps to extend the life of these devices.

HANDHELD PC SOLUTIONS

FORM-FIT POWERED HOLDERS FOR TC70, TC72, TC75 & TC77

RAM-HOL-ZE7U
Non-Locking

RAM-HOL-ZE7CLU
Combo-Locking

RAM-HOL-ZE7LU
Key-Locking

Compatible with the RAM-GDS-CHARGE-V10U for hardwire applications

FORM-FIT POWERED HOLDER FOR TC51, TC52, TC56 & TC57

RAM-HOL-ZE6U
Non-Locking

RAM-HOL-ZE14U
RAM® Form-Fit Powered Holder for Zebra TC21 & TC26

TABLETS

RAM-HOL-ZE10PD2CLU
GDS® Combo Locking Power + Dual USB Dock for Zebra ET5x 8.3" Series

RAM-HOL-ZE10PD2KLU
GDS® Key Locking Power + Dual USB Dock for Zebra ET5x 8.3" & 8.4" Series

RAM-HOL-ZE11PD2CLU
GDS® Combo Locking Power + Dual USB Dock for Zebra ET5x 10.1" Series

RAM-HOL-ZE11PD2KLU
GDS® Key Locking Power + Dual USB Dock for Zebra ET5x 10.1" Series

ZEBRA SCANNER SOLUTIONS

Different types of scanner guns need different types of mounting solutions. Between the RAM® Quick-Draw™ and the RAM® Power-Grip™ we've effectively provided holders that cover a wide variety of scanner guns of different shapes and sizes. All RAM® Mounts Compatible™, these scanner gun holders have thoughtful design choices such as elastomeric fins that keep the scanner in place but are easy to remove when working fast.



RAM-HOL-ZE9U
RAM® Quick-Draw™ Holder for Zebra TC8000/8300

RAM® POWER-GRIP™



RAP-396U
RAM® Power-Grip™ Holder for Zebra
3600 Series



**BEST
SELLER**

RAP-450U
RAM® Power-Grip™ XL Holder for
Zebra MC9300

Features replaceable
elastomeric fins for a
secure fit

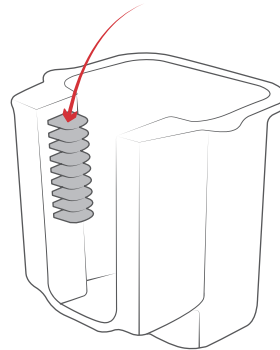

PRINTER SOLUTIONS

QLN SERIES, ZQ500 SERIES, ZQ600 SERIES



RAM-VPR-104
RAM® Quick-Draw™ Jr. Universal Small Printer Holder

PANASONIC AND HONEYWELL

RAM® builds premium solutions for a variety of rugged Honeywell and Panasonic devices including the Toughbook® and Toughpad®, handheld PCs, tablets, monitors and laptops. Utilizing our form-fitting cradle design and huge selection of RAM® components, securing your device wherever you need it has never been easier. The versatility of RAM® systems allow you to efficiently move your device between your car, desk, forklift, and much more. Allowing for near-infinite adjustability as well as vibration damping, the RAM® double ball and socket system provides maximum versatility and helps to extend the life of these devices.

PANASONIC



RAM-HOL-PAN11PKLU
RAM® Key-Locking Form-Fit Powered Cradle for Panasonic FZ-N1 & FZ-F1



RAM-HOL-PAN14U
RAM® EZ-Roll'r™ Cradle for Panasonic FZ-T1



RAM-HOL-PAN11PCLU
RAM® Combo-Locking Form-Fit Powered Cradle for Panasonic FZ-N1 & FZ-F1



RAM-HOL-PAN11PU
RAM® Form-Fit Powered Cradle for Panasonic FZ-N1 & FZ-F1

HONEYWELL



RAM-HOL-HON7CLU
RAM® Combo-Locking Form-Fit Powered Cradle for Honeywell CT50 & CT60



RAM-HOL-HON7KLU
RAM® Key-Locking Form-Fit Powered Cradle for Honeywell CT50 & CT60



RAM-HOL-HON7U
RAM® Form-Fit Powered Cradle for Honeywell CT50 & CT60



SEEN IN THIS PHOTO:

RAM-HOL-SNM1LU

RAM® EZ-Roll'r™ Locking Cradle for Sonim XP5s

SONIM

RAM® Mounts has partnered with Sonim to develop an ultra-rugged cradle to perfectly compliment the ultra-rugged XP5s and XP8. Featuring powered and key locking variations, these rugged solutions are designed to get the job done in the field while keeping your XP5s and XP8 charged and secure from theft. Each RAM® EZ-Roll'r™ Cradle for Sonim XP5s and XP8 are RAM® Mounts Compatible™ and can be upgraded to the speaker and microphone bundle for an all-in-one communication hub.

SONIM XP5S



Locking

RAM-HOL-SNM1LU
RAM® EZ-Roll'r™ Locking
Cradle for Sonim XP5s

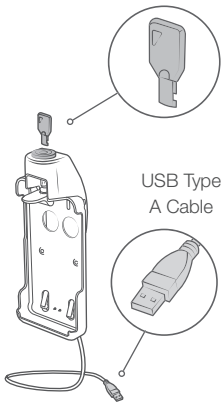

Locking

USB Type
A Cable

RAM-HOL-SNM1PLU
RAM® EZ-Roll'r™ Powered
Locking Dock for Sonim XP5s

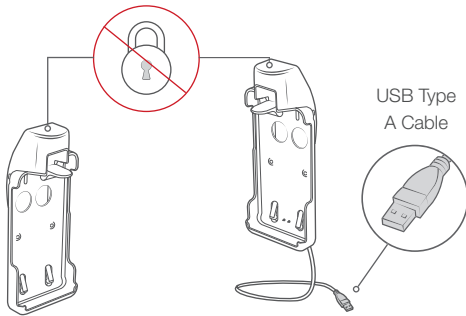

RAM-HOL-SNM1U

RAM® EZ-Roll'r™ Cradle for
Sonim XP5s

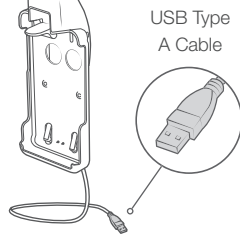

USB Type
A Cable

RAM-HOL-SNM1PU
RAM® EZ-Roll'r™ Powered Dock
for Sonim XP5s

SONIM XP8



Locking

RAM-HOL-SNM2LU
RAM® EZ-Roll'r™ Locking
Cradle for Sonim XP8

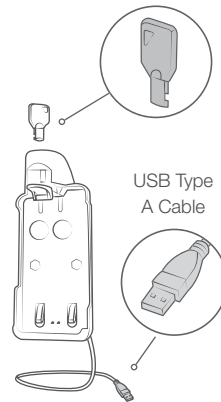

Locking

USB Type
A Cable

RAM-HOL-SNM2PLU
RAM® EZ-Roll'r™ Powered
Locking Dock for Sonim XP8

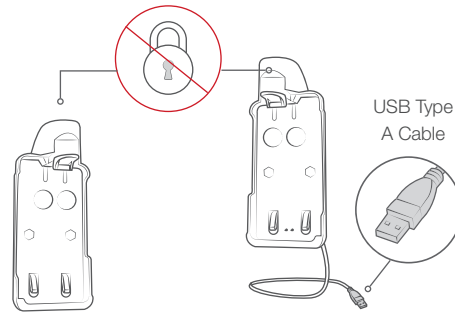

RAM-HOL-SNM2U

RAM® EZ-Roll'r™ Cradle for
Sonim XP8

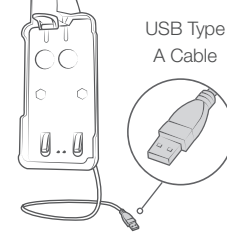

USB Type
A Cable

RAM-HOL-SNM2PU
RAM® EZ-Roll'r™ Powered Dock
for Sonim XP8



SEEN IN THIS PHOTO:

RAM-138-S-SNM2PLU

RAM® Double Ball Mount for Sonim XP8
with Speaker & Hardwire Bundle

RAM-VB-138

RAM® No-Drill™ Vehicle Base for '05-21
Toyota 4Runner & Tacoma

RAM-VP-SW1-89

RAM® Tele-Pole™ with 8" & 9" Poles,
Double Swing Arms & Round Plate

SONIM BUNDLE FOR SONIM XP5S & SONIM XP8

The Sonim bundles are perfect communication hubs to enable the Sonim XP5s and XP8's Push-to-Talk functionality. Equipped with an audio amplification speaker, locking cradle and microphone, field service workers can use the PTT features of the Sonim device without having to fiddle with the device itself out on the road. Each bundle also includes a Pin-Lock™ knob for the socket arm as well as a key lock for the cradle, leaving your communication system free from theft. All connections are made possible through the custom RAM® Adapter Cable—a 6" highly shielded cable adapter that securely connects to the Sonim XP5s and XP8 "SecureAudio" contacts via pogo pins, using a threaded thumb fastener on one end with a ruggedized 3.5mm female connector on the other end. The 3.5mm female connector and audio control logic allow the use of the Sonim XP5s and XP8 handsets with headsets, microphones, PTT mic's and external speakers.



BUNDLE FOR SONIM XP5S

RAM-138-S-SNM1PLU

RAM® Double Ball Mount for Sonim XP5s with Speaker & Hardwire Bundle

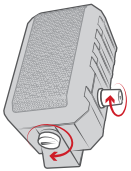

1

The GDS® Audio™ amplified speaker can be hardwired into the cab of your vehicle – with no batteries required for power

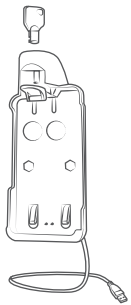

2

Spring-loaded, powered RAM® EZ-Roll'r™ style form-fit cradle provides a perfect fit for your device without a case while keeping the device charged



3

RAM® Microphone with Steel Mounting Clip

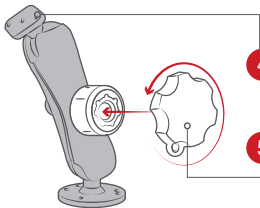

4

RAM® ball and socket technology allows for near infinite adjustability.

5

RAM® Pin-Lock™ for theft deterrence

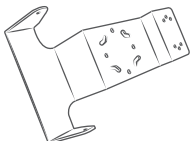

6

Mounting bracket for all-in-one communication



BUNDLE FOR SONIM XP8

RAM-138-S-SNM2PLU

RAM® Double Ball Mount for Sonim XP8 with Speaker & Hardwire Bundle

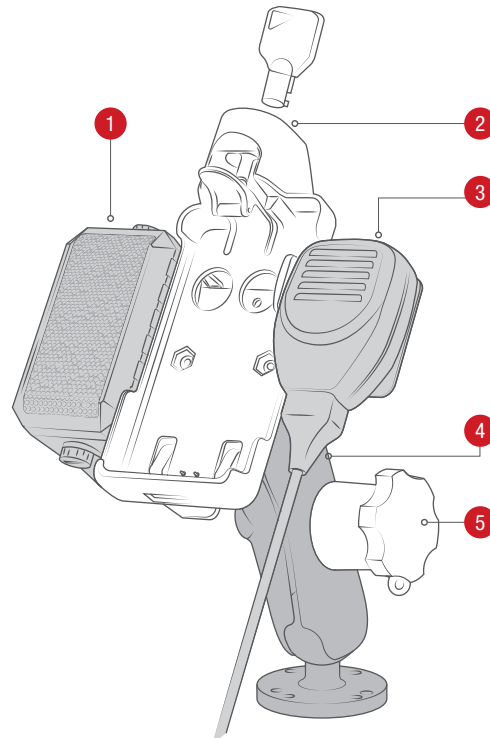

SEEN IN THIS PHOTO:

RAM-HOL-0T3U

RAM® Quick Release Holder for OtterBox uniVERSE Case

RAM-HOL-0T3BU

RAM® Adapter for OtterBox uniVERSE Case





OTTERBOX UNIVERSE SOLUTIONS

The RAM® EZ-Roll'r™ phone holder secures your OtterBox uniVERSE-protected iPhone, allowing you to utilize the RAM® Twist-Lock™ Suction Cup or RAM® Tough-Claw™. For anyone who demands both protection and versatility, the combination of the OtterBox uniVERSE case and the RAM® double ball and socket system is the answer.



PHONE SOLUTIONS

RAM-B-166-OT2U

Suction Cup Mount for OtterBox uniVERSE Phone Cases
Not compatible with Samsung XCover Pro

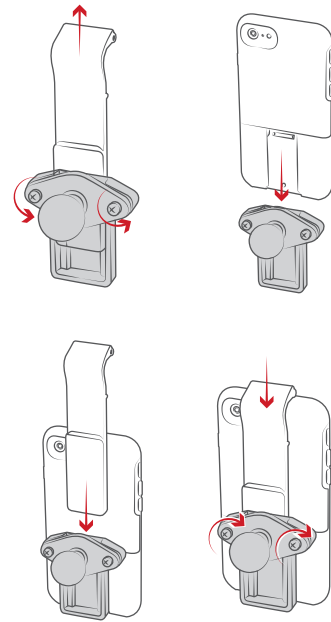

PHONE SOLUTIONS FOR OTTERBOX UNIVERSE - APPLE & SAMSUNG



RAM-HOL-SAM9P-OT2U
Powered Form-Fit Dock for Samsung XCover Pro



RAM-GDS-OT2U
GDS® Module for Samsung S9, S10 & S10e

TABLET SOLUTIONS FOR OTTERBOX UNIVERSE - APPLE & SAMSUNG



RAM-HS1-OT3BU
GDS® Hand-Stand™—Two in One Handstrap & Kickstand



RAM-316-HD-238-OT3U
RAM® Pod HD™ Vehicle Floor Mount



RAM-GDS-OT1U
GDS® Module for Apple iPad Air 2 & Pro 9.7

SEEN IN THIS PHOTO:

RAM-B-408-75-1-A-238U

RAM® Torque™ Medium Rail Base with Diamond Plate

RAM-HOL-PD3U

RAM® Quick-Grip™ Phone Holder



MOTORCYCLE MOUNTS

FEATURED PRODUCTS

RAM® Mounts for motorcycles are the most recognizable mounting solutions on the market. With options to mount anywhere on the handlebars of many different motorcycles, RAM® also offers gas tank mounts, fork stem mounts and more. From phone mounts to action camera mounts, explore the full line of motorcycle mounts in this next section.

PHONE MOUNTS



RAM-HOL-UN7-400U
RAM® X-Grip® Phone Mount with RAM® Snap-Link™ Tough-Claw™

RAM-B-149Z-A-UN10U
RAM® X-Grip® Large Phone Mount with Handlebar U-Bolt Base

BEST SELLER

RAM-B-149Z-A-PD4U
RAM® Quick-Grip™ XL Phone Mount with Handlebar U-Bolt Base



RAM-B-149Z-A-UN12W-V7M
RAM® Tough-Charge™ Waterproof Wireless Charging Motorcycle Mount



RAM-B-149Z-A-UN14W-V7M
RAM® Quick-Grip™ Waterproof Wireless Charging Handlebar Mount

GOPROS & ACTION CAMERAS



RAM-B-176-GOP1U
RAM® Motorcycle Fork Stem Mount with Universal Action Camera Adapter



RAP-B-GOP2-A-GOP1U
RAM® Ball Adapter for GoPro® Bases with Universal Action Camera Adapter



RAM-B-411-A-GOP1U
RAM® Large Gas Tank Mount with Universal Action Camera Adapter

GPS/RADIOS



RAM-B-149Z-GA46
RAM® Handlebar U-Bolt Double Ball Mount for Garmin Montana 600 Series



RAM-B-174-UN4U
RAM® Finger-Grip™ Universal Mount with Brake/Clutch Reservoir Base



RAM-B-149Z-2-GA41U
RAM® ATV/UTV Rail Mount for Garmin Astro 320, GPSMAP 62 + More



RAM-B-149Z-A-GA76U
RAM® Spine Clip Garmin Mount with Handlebar U-Bolt Base

RIGGING MAP FOR MOTORCYCLES



1 **RAM-B-408-112-15U**
RAM® Torque™ Large
Rail Base (pg. 123)



2 **RAM-B-309-7U**
RAM® Motorcycle
Brake/Clutch Reservoir
& Handlebar Ball Base
(pg. 125)



3 **RAP-B-379-HA1U**
RAM® Tough-Ball™
Mirror Base for Harley-
Davidson Motorcycles
(pg. 132)



4 **RAM-B-2312U**
RAM® Handlebar U-Bolt
Base for Rails 0.5" to
1.25" in Diameter
(pg. 120)

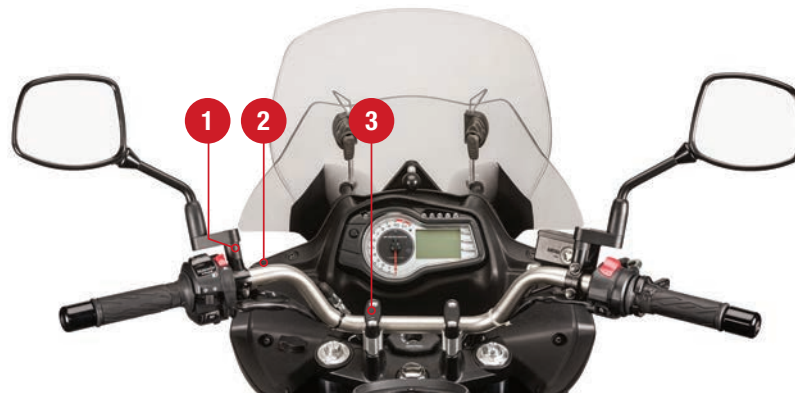

1 **RAM-B-349U**
RAM® Ball Adapter with M10 X 1.25
Threaded Post (pg. 130)



2 **RAP-B-400U**
RAM® Tough-Claw™ Small Clamp
Base with Ball (pg. 122)

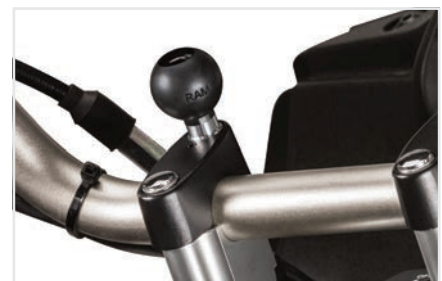

3 **RAM-B-367U**
RAM® Motorcycle Handlebar Clamp
Base with M8 Bolts (pg. 127)



1 **RAM-B-408-75-1U**
RAM® Torque™ Medium Rail Base (pg. 123)



2 **RAM-B-252U**
RAM® 11mm Bolt Head Adapter Ball Base (pg. 128)



3 **RAM-B-345U**
RAM® Centered Reservoir Cover Ball Base (pg. 126)



1 **RAM-B-309-7U**
RAM® Motorcycle Brake/Clutch Reservoir & Handlebar Ball Base (pg. 125)

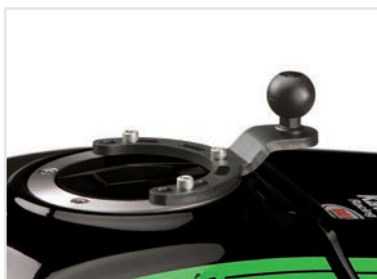

2 **RAM-B-410U**
RAM® Small Gas Tank Ball Base for Motorcycles (pg. 129)



3 **RAM-B-342U**
RAM® Motorcycle Fork Stem Ball Base (pg. 124)



SEEN IN THIS PHOTO:

RAM-B-149Z-GOP1U

U-Bolt Handlebar Mount with Universal
Action Camera Adapter

SEEN IN THIS PHOTO:

RAM-B-149Z-A-UN12W-V7M

RAM® Tough-Charge™ Wireless Charging Motorcycle Mount with Charger



**BEST
SELLER**

MOTORCYCLE MOUNTS CONTINUED

**HANDLEBAR
MOUNTING
U-BOLT
HANDLEBAR BASE**

This base has a 1" diameter rubber ball designed to sit at right angles on the mounting rail. The zinc-coated and stainless steel U-bolts accommodate rails from .5" to 1.25" in diameter. Black caps are included to cover the exposed ends of the U-bolt and a composite adapter can narrow the minimum diameter of the rail to .5".

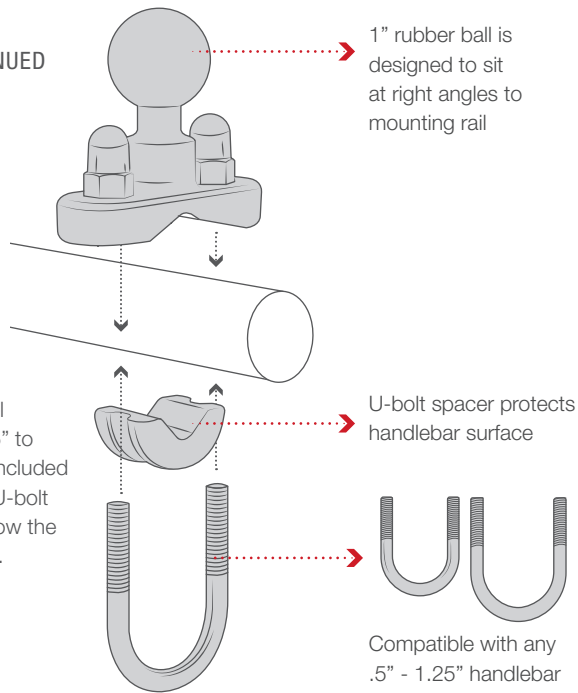

RAM-B-231ZU

.5" to 1.25" Diameter Single U-Bolt Base



RAM-B-231CHU

.5" to 1" Diameter Single U-Bolt Base in Chrome



RAM-B-231U

.5" to 1" Diameter Single U-Bolt Base

FEATURES

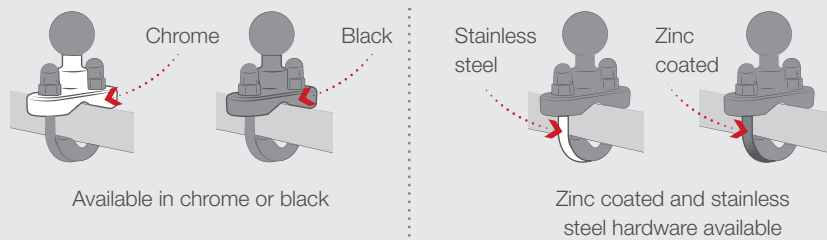

SEEN IN THIS PHOTO:

RAM-B-400-A-UN14W-V7M

RAM® Quick-Grip™ Waterproof Wireless Charging Mount with Tough-Claw™





RAP-B-401U
1" - 2.25" Diameter



RAP-B-404U
1" - 1.875" Diameter



**BEST
SELLER**

RAP-B-400U
.625" - 1.5" Diameter

MOTORCYCLE MOUNTS CONTINUED

**HANDLEBAR
MOUNTING
RAM® TOUGH-CLAW™**

The RAM® Mounts Tough-Claw™ is the perfect mounting base for quick installation and removal on round, square and odd-shaped rails and bars – such as handlebars or roll cages. The RAM® Tough-Claw™ can be clamped on rails from .625" to 2.25" in diameter, making this an ideal solution for mounting action cameras, phones and much more.

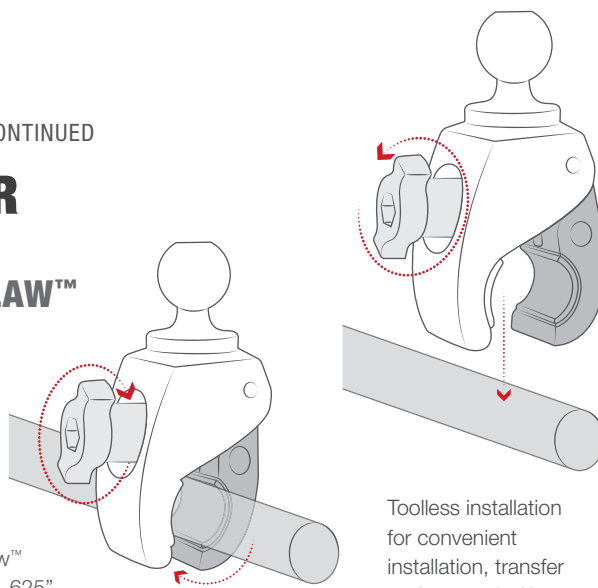

Toolless installation for convenient installation, transfer and removal of base

FEATURES

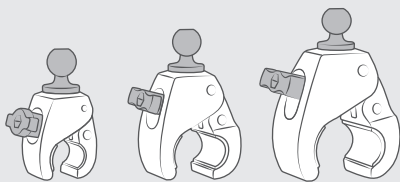

Available in three sizes to accommodate all handlebars and roll bars



Compatible with round or odd-shaped rails



Made of high-strength composites for durability and reliability in the most demanding environments



SEEN IN THIS PHOTO:

RAM-B-408-37-62-A-UN7U
 RAM® X-Grip® Phone Mount with RAM® Torque™ Small Rail Base



SEEN IN THIS PHOTO:

RAM-B-408-75-1-UN7U
 RAM® X-Grip® Phone Mount with RAM® Torque™ Medium Rail Base

MOTORCYCLE MOUNTS CONTINUED

HANDLEBAR MOUNTING

RAM® TORQUE™

RAM® Mounts Torque™ bases fit a variety of rail and bar sizes for secure placement of your device. Sizing inserts create a tight hold while protecting the bar, and the cast aluminum mount is available with a 1" or 1.5" rubber ball that attaches to a RAM® arm. Mount your GPS unit, camera, phone or tablet to handlebars, roll cages or even mirror posts.

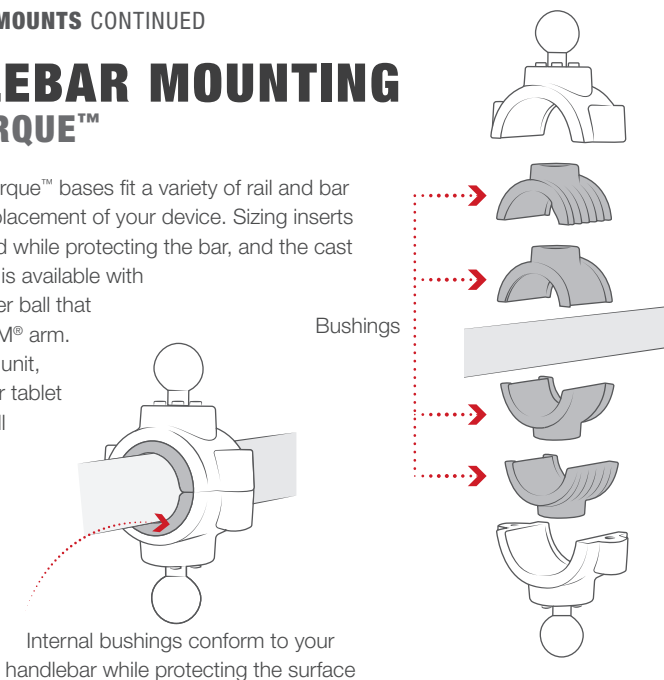

RAM-B-415-15-2U
 RAM® Torque™ 1 1/2" - 2" Diameter Rail Base



RAM-B-408-112-15U
 1.125" to 1.5" Diameter RAM® Torque™ Base



RAM-B-408-75-1U
 .75" to 1" Diameter RAM® Torque™ Base



RAM-B-408-37-62U
 RAM® Torque™ Small Rail Base

FEATURES

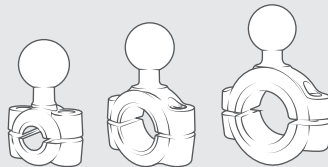

Various sizes to support rails from .375" to 1.5" in diameter



Made of long lasting marine-grade aluminum



Included rubber strip offers additional friction



SEEN IN THIS PHOTO:

RAM-B-342
Fork Stem Base

RAM-B-201U-A
Short Double Socket Arm

RAP-B-202U-GOP1
Universal Action Camera Adapter

HANDLEBAR MOUNTING FORK STEM

The fork stem base is designed to fit and expand into the cylindrical bore wall of fork stems and will work with stems that measure 12 to 38mm (.5" to 1.49") in diameter. The base is made of powder-coated, marine-grade aluminum and includes a 1" diameter rubber ball.

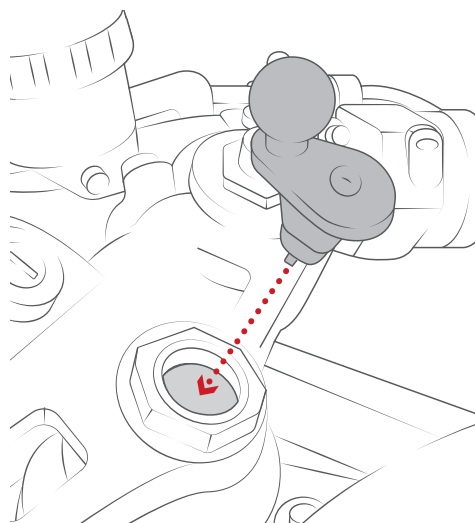

Centered, low profile base mounts your device in the ideal position



RAM-B-342U
RAM® Motorcycle Fork Stem
Ball Base

FEATURES



Fits fork stem holes from
12mm - 38mm
(.5" - 1.49") in diameter

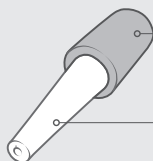

27-38mm fork
stem holes
12-26mm fork
stem holes



Made of long lasting
marine-grade aluminum

SEEN IN THIS PHOTO:

RAM-B-174-UN7U

RAM® X-Grip® Phone Mount with
Motorcycle Brake/Clutch Reservoir Base



RAM-B-309-6U

RAM® Motorcycle Brake/Clutch Reservoir
Double Ball Base



**BEST
SELLER**

RAM-B-309-7U

RAM® Motorcycle Brake/Clutch Reservoir
& Handlebar Ball Base



RAM-B-309-2CHU

RAM® Chrome Motorcycle Brake/Clutch
Reservoir Double Ball Base

MOTORCYCLE MOUNTS CONTINUED

**SURFACE
MOUNTING
BRAKE/CLUTCH
RESERVOIR BASE**

The combination handlebar and brake/clutch reservoir base provides the ultimate flexibility for mounting your device to your motorcycle. The kit contains standard and metric threaded stainless bolts as well as zinc-coated metal U-bolts accommodating rails from .5" to 1.25" in diameter.



RAM-B-309-1CHU

RAM® Chrome Motorcycle
Brake/Clutch Reservoir
Ball Base

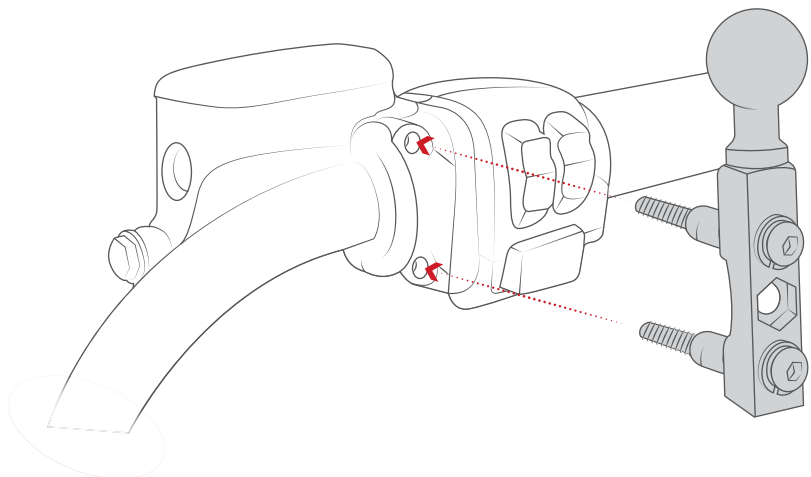



SEEN IN THIS PHOTO:

RAM-B-346U

RAM® Offset Reservoir Cover Ball Base

RAM-B-103U

RAM® Double Socket Arm with Round Plate

RAP-300-1U

RAM® Power Plate™ III Universal Magnetic Holder

SURFACE MOUNTING RESERVOIR COVER BASE

These bases fit over your existing brake/clutch reservoir cover with either a 1" offset ball or a 1" center ball. The plate dimensions for the center ball base measure 2.87" x 1.82", compared to 4" x 1.82" for the offset ball base.

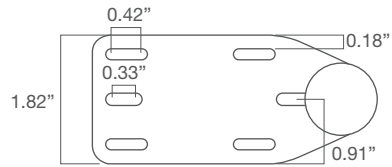
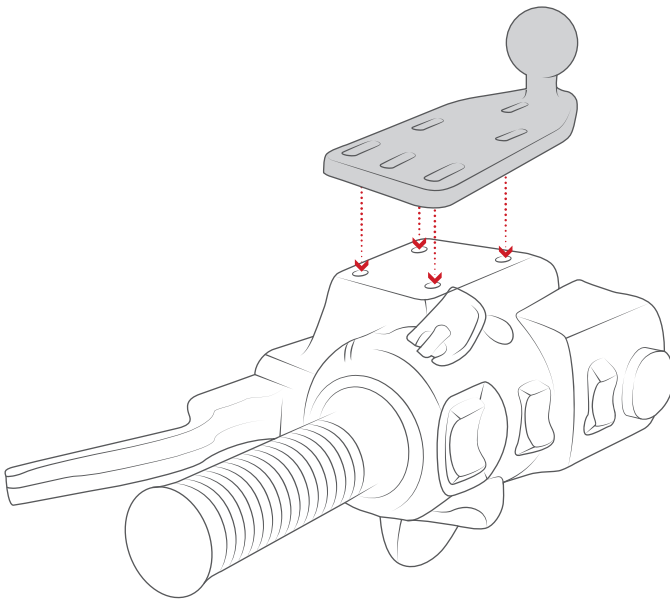

RAM-B-346U

RAM® Offset Reservoir Cover
Ball Base

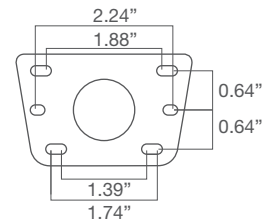

RAM-B-345U

RAM® Centered Reservoir Cover
Ball Base



SEEN IN THIS PHOTO:

- RAM-B-367U**
Handlebar Clamp Base
- RAM-B-201U**
RAM® Double Socket Arm
- RAM-B-202-GA76U**
RAM® Spine Clip Holder
with Ball for Garmin
Handheld Devices

MOTORCYCLE MOUNTS CONTINUED

SURFACE MOUNTING HANDLEBAR CLAMP BASE

This 1" rubber ball base will replace an M8 by 25mm, 30mm or 35mm handlebar bolt. To determine compatibility, measure the bolt length and add 30mm to the length. Screw the ball base onto the handlebar top clamp using one of three included 1.25mm thread pitch bolts: M8 x 55mm, M8 x 60mm and M8 x 65mm.



**BEST
SELLER**

RAM-B-367U

RAM® Motorcycle Handlebar Clamp Base with M8 Bolts

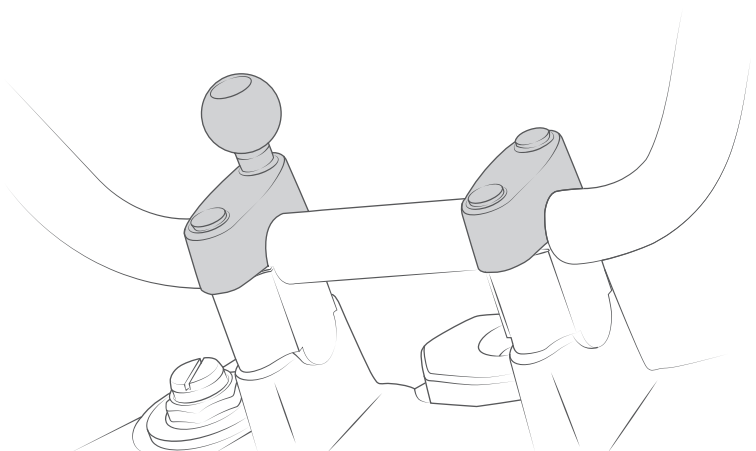

SEEN IN THIS PHOTO:

RAM-B-252U

Bolt Head Flat Base

RAM-B-201U-A

Short Double Socket Arm

RAP-B-202U-GOP1

Universal Action
Camera Adapter



SURFACE MOUNTING BOLT HEAD ADAPTER BASES

The versatile flat base – with a bolt-down area of 2.25" x .875" x .2" – includes a 1" diameter rubber ball and an 11mm hole. The angled base version also includes a 1" diameter rubber ball and a 9mm hole, and a bolt-down area of 1.125" x .75" x .2". Both bolt head adapter bases are often attached to the mirror frame and fit well on exposed bolts.

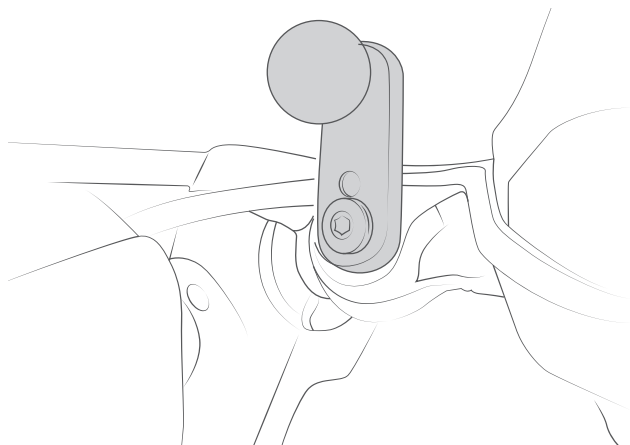

RAM-B-252U

2.25" x .875" Plate 11mm Hole



RAM-B-272U

1.125" x .75" Plate 9mm Hole



SEEN IN THIS PHOTO:

RAM-B-410-A-UN10BU
 Small Gas Tank Mount with
 RAM® X-Grip® Phone Holder

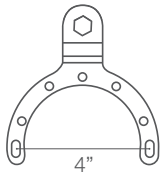

RAM-B-411U
 Large Gas Tank Base

MOTORCYCLE MOUNTS CONTINUED

**SURFACE MOUNTING
 GAS TANK BASE**

This base is a low-profile way to get a unique perspective from your action camera or to attach your device where it can be easily accessed. Hardware is included for mounting to the fill port for stock tanks on most popular makes, such as BMW, Honda, Kawasaki, Suzuki and Yamaha.

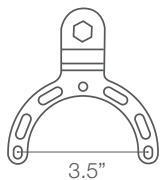
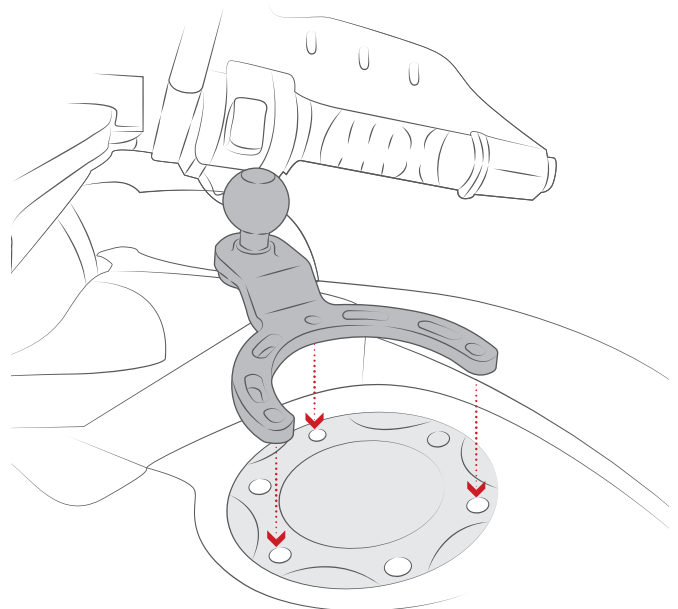

RAM-B-410U
 Small Gas Tank Base



SEEN IN THIS PHOTO:

- RAM-B-349U**
Threaded Ball Adapter
- RAM-B-201U-A**
Short Double Socket Arm
- RAM-HOL-UN7BU**
RAM® X-Grip® Phone Holder

SURFACE MOUNTING THREADED BALL ADAPTERS

Take advantage of your unused mirror sockets with these threaded bases, available with a M10 x 1.25 pitch male thread or a M10 x 1.5 pitch male thread. Both bases feature a RAM® B size (1") ball so you can connect a wide range of mounting solutions.



RAM-B-349U
RAM® Ball Adapter w/
M10 X 1.25" Threaded Post

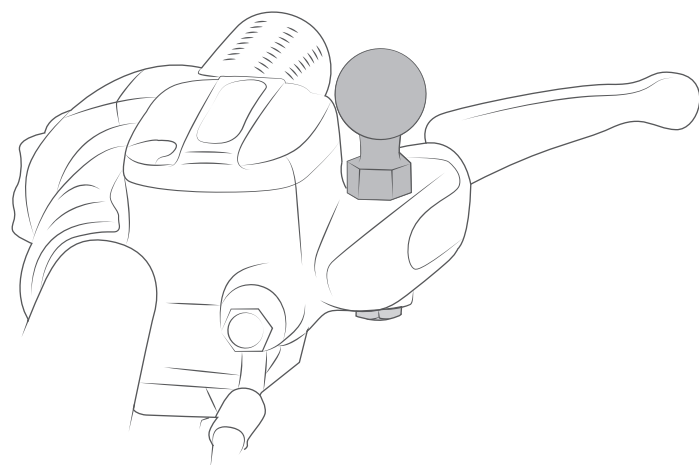

RAM-B-236U
RAM® Ball Adapter with 3/8"-16
Threaded Post



**BEST
SELLER**

RAM-B-349-1U
RAM® Ball Adapter with
M10 X 1.5" Threaded Post

SEEN IN THIS PHOTO:

RAP-B-379-HA1U

RAM® Tough-Ball™ for Harley Davidson

RAM-B-201U

Medium Double Socket Arm

RAP-B-202U-GOP1

Universal Action Camera Adapter



SURFACE MOUNTING RAM® TOUGH-BALL™ FOR HARLEY DAVIDSON

The RAM® Tough-Ball™ low-profile mounting base is designed to mount directly through the mirror holes on a standard Harley-Davidson. The included barrel nut enables you to mount the ball on top or below the hand grips where the mirror holes are located, helping to ensure a clear line of sight.

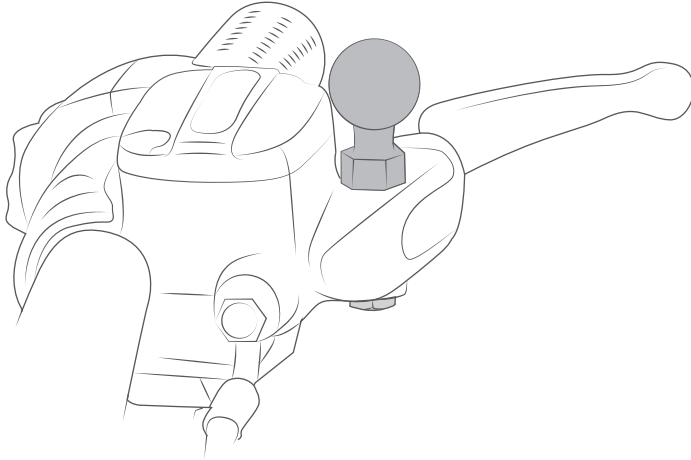

**BEST
SELLER**

RAP-B-379-HA1U

RAM® Tough-Ball™ Mirror Base for Harley-Davidson Motorcycles

RAM® TWIST AND TILT™

The RAM® Twist and Tilt™ threads into the stock mirror location, giving users the ability to twist the mount 360 degrees, while the 1" ball can be tilted 180 degrees. Designed to be discrete and made of die cast marine-grade aluminum, this versatile pivot base provides numerous mounting possibilities.

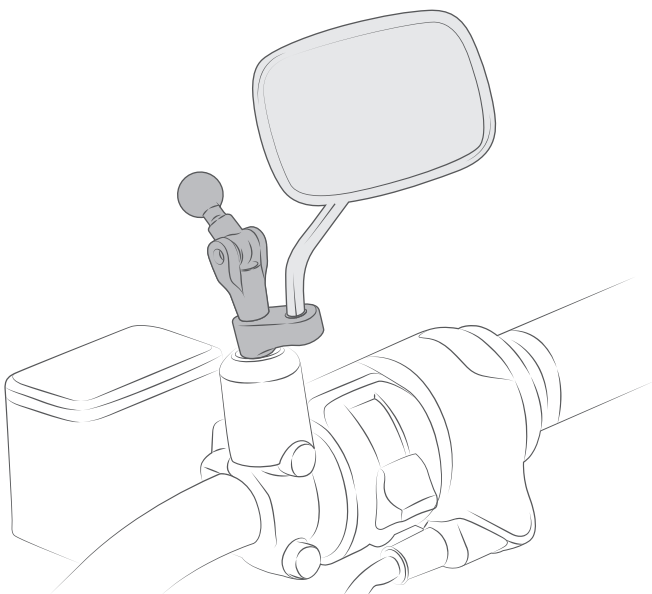

RAM-B-360U

RAM® Twist and Tilt™ Motorcycle Mirror Ball Base



SEEN IN THIS PHOTO:

RAM-B-309-7U
Brake/Clutch Reservoir Base

RAM-B-201U
Medium Double Socket Arm

RAM-HOL-UN7BU
RAM® X-Grip® Phone Holder

ACCESSORIES & MORE

ARMS

Black arms available in short, standard and long sizes, RAM® Mounts B size double socket arms accommodate 1" ball bases. RAM® ball and socket technology allows for near infinite adjustability.

Almost all RAM® Mounts you've seen have likely been all black. But our chrome double socket arms—available only in B size (1") - are the perfect match for motorcycle handlebars.

The double socket swivel arm consists of two 1" open ball sockets with a 360 degree rotation point at the center of the arm. With the multi-pivot arm, a connected swivel joint rotates 180 degrees.

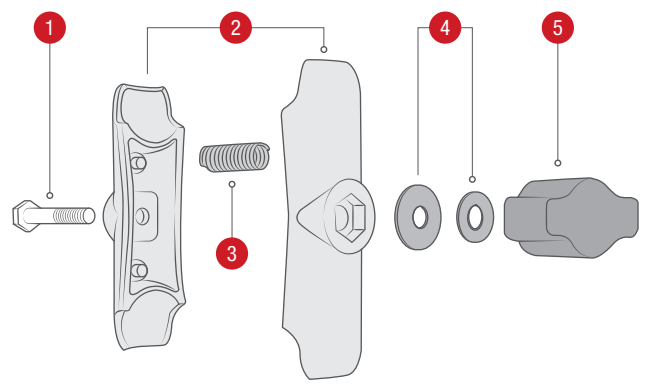
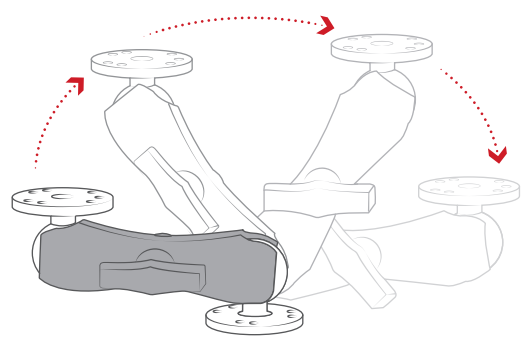

- 1 Center bolt bridges the gap between both halves of the socket arm
- 2 This socket technology allows for almost infinite adjustment and perfect viewing angles.
- 3 A single spring inside the arm opens the end sockets, allowing you to pivot the ball and socket connection.
- 4 Stainless steel and nylon washers ensure smooth and secure friction when tightening your mount.
- 5 High strength knob with brass threading keeps your mount tight for the long term.



RAM-B-201U-A
Overall length: 2.38"
Socket-to-socket: 1.75"



BEST SELLER
RAM-B-201U
Overall length: 3.69"
Socket-to-socket: 3"



RAM-B-201U-C
Overall length: 6"
Socket-to-socket: 5.25"



RAM-B-201-ACHU
Overall length: 2.38"
Socket-to-socket: 1.75"



RAM-B-201CHU
Overall length: 3.69"
Socket-to-socket: 3"



RAP-B-200-12U
Overall length: 4.25" Socket-to-socket: 3.625"



RAP-B-200-2U
Overall length: 6.25" Socket-to-socket: 5.625"

SEEN IN THIS PHOTO:

RAM-B-408-112-15-238U

RAM® Torque™ Handlebar Mount

RAM-HOL-PD3-238AU

RAM® Quick-Grip™ Phone Holder

RAM-B-273U

RAM® Add-A-Ball™ Accessory

RAM-B-201U-A

Short Double Socket Arm

RAP-B-202U-GOP1

Universal Action Camera Adapter



ARM ACCESSORIES

With the RAM® Mounts Add-A-Ball™, connect another device to your existing mount by utilizing another 1" ball. To connect two arms, use the RAM® double ball adapter.

Using a female threaded security knob and key knob, the mixed combination RAM® Pin-Lock™ Security Knob can replace all knobs on B and C size arms and mounts to prevent theft and tampering of your electronics. When outfitting a fleet, the RAM® Pin-Lock™ can be keyed alike.



RAM-B-230U
RAM® Double Ball Adapter

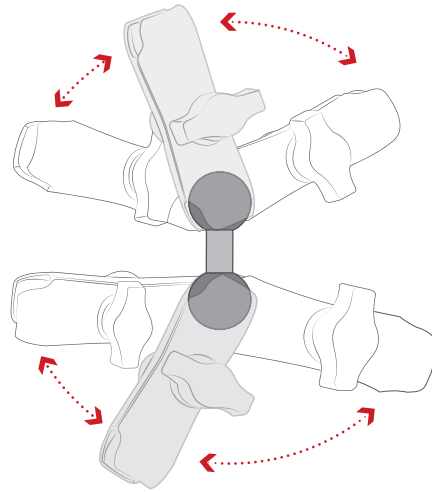

The perfect adapter for connecting two B size RAM® Mounts double socket arms for extra extension or articulation

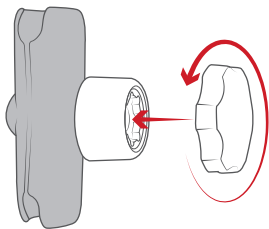

RAP-S-KNOB5U
RAM® Pin-Lock™ Security Knob
for C Size Socket Arms

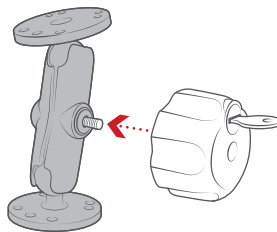

RAM-KNOB3LU
RAM® Key Lock Knob with Brass Insert
for B Size Socket Arms

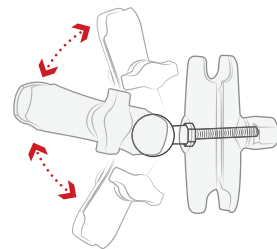

**BEST
SELLER**

RAM-B-273U
RAM® Add-A-Ball™ Accessory Ball
for B Size Socket Arms

SEEN IN THIS PHOTO:

RAM-B-408-112-15U
RAM® Torque™ Rail Base

RAM-B-201U-A
Short Double Socket Arm

RAP-B-417BU
RAM® Level Cup™ XL Drink Holder



W.D. BARNHART & COMPANY
DATE MANUFACTURED: 01/15
DATE: 6/17 KG (13.0 LB) WITH 1109000111
CARRY FRONT - 227 KG (500 LB) IN
CARRY X 3.50 KG (7.70 LB) COIL
13 X 3.50 KG (7.70 LB) COIL
13 X 3.50 KG (7.70 LB) COIL

DRINK HOLDER MOUNTS

Grab your Yeti and hit the road! Need an extra cup holder for your morning coffee? The RAM® Level-Cup™ is a self-leveling drink holder that comes in two sizes—16oz and 32oz. No matter how harshly you drive or ride your motorcycle, the Level-Cup™'s self-leveling technology keeps your precious coffee in the cup and not all over the ground, or on you.

FEATURES



Self-leveling swivel mount prevents spills

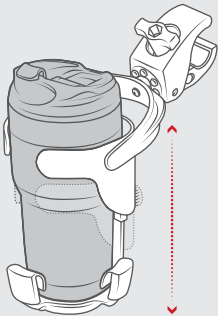

Height adjusts for 32oz holder



RAM-B-132-400U
RAM® Level Cup™ 16oz Drink Holder with RAM® Tough-Claw™ Mount

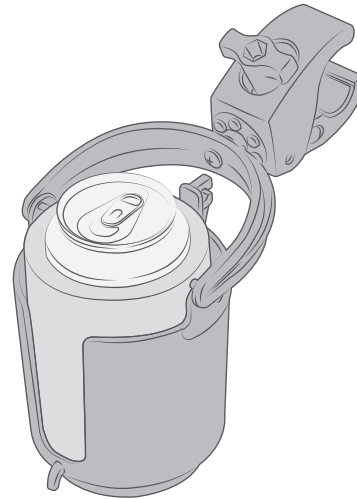

16oz drink compatibility



RAM-B-408-75-1-A-132U
RAM® Level Cup™ 16oz Drink Holder with RAM® Torque™ Medium Rail Base



RAM-B-132RU
RAM® Level Cup™ 16oz Drink Holder with Handlebar U-Bolt Base



RAM-B-417B-C-354-TRA1U
RAM® Level Cup™ XL 32oz Drink Holder with RAM® Track Ball™ Base

BEST SELLER



RAP-B-417-400U
RAM® Level Cup™ XL 32oz Drink Holder with RAM® Tough-Claw™



RAP-B-417BU
RAM® Level Cup™ XL 32oz Drink Holder with Ball

SEEN IN THIS PHOTO:

RAP-SB-187-UN7U

RAM® X-Grip® Phone Mount with
RAM® EZ-Strap™ Rail Mount



BICYCLE MOUNTS

RAM® EZ-STRAP™ & EZ-ON/OFF™

The RAM® EZ-Strap™ consists of the EZ-Strap™ base featuring a locking mechanism for attaching any RAM® Snap-Link™ Ball with a 2-hole AMPS pattern or the universal X-Grip® cradle. The strap can be cut to fit tubing, square rails and irregular shapes from 0.5" to 2.58" in diameter. Multiple adjustment points allow you to move the device holder to your optimum viewing position. This mount rotates 180 degrees.



RAP-SB-187-UN7U
RAM® X-Grip® Phone Mount with
RAM® EZ-Strap™ Rail Mount



RAM® EZ-Strap™ can be easily transferred to multiple bikes



**BEST
SELLER**

RAP-274-1-UN7U
RAM® X-Grip® Phone Mount with
RAM® EZ-On/Off™ Bicycle Base



RAP-274-1U + RAM-HOL-GA76U
RAM® EZ-On/Off™ Bicycle Mount
+
RAM® Spine Clip Holder for
Garmin Handheld Devices

FEATURES

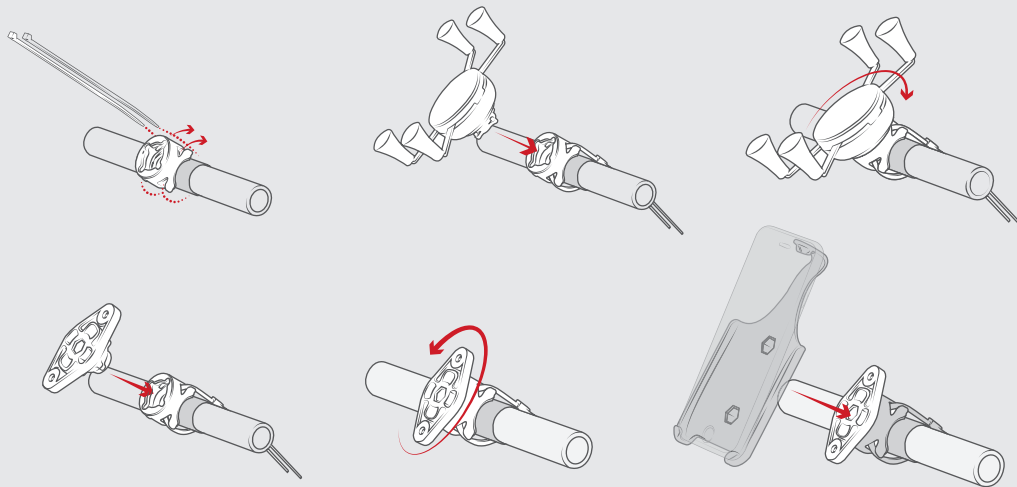

RAM® EZ-On/Off™ lets you mount multiple devices to your bike

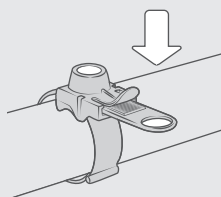

Lightweight and low profile



Made of high-strength composites for durability and reliability in the most demanding environments

SEEN IN THIS PHOTO:

RAM-HOL-UN7-400-1U

RAM® X-Grip® Phone Mount with Low-Profile RAM® Tough-Claw™



SEEN IN THIS PHOTO:

RAM-HOL-UN7-400-1U

RAM® X-Grip® Phone Mount with Low-Profile RAM® Tough-Claw™



BICYCLE MOUNTS CONTINUED

RAM® TOUGH-CLAW™ LOW PROFILE

Combining the RAM® X-Grip™ holder and the RAM® Tough-Claw™ makes the ideal low profile phone mount for all types of handlebars, rails and tubes. For those who don't need too much articulation from any of RAM®'s socket arm configurations, this mounting solution is easy and straightforward, allowing you to quickly install or remove your device from it's mounting surface.



RAM-HOL-UN10-400-1U
RAM® X-Grip® Large Phone Mount with Low-Profile RAM® Tough-Claw™



RAM-HOL-UN7-400-1U
RAM® X-Grip® Phone Mount with Low-Profile RAM® Tough-Claw™



SEEN IN THIS PHOTO:

RAM-TRACK-EXA-9U
9" Modular Aluminum
RAM® Tough-Track™

RAP-B-354U-TRA1
RAM® Track Ball™ with
T-Bolt Attachment

RAM-B-103U-C
RAM® Double Socket
Arm with Round Plate

RAM-HOL-UN11U
RAM® X-Grip®
Universal Holder for
12" Tablets



SEEN IN THIS PHOTO:

RAM-TRACK-EXA-5U
5" Modular Aluminum
RAM® Tough-Track™

RAP-412U
RAM® Roller-Ball™
Accessory Holder

RV/MOTORHOME

RVs and motorhomes are extensions of our normal home, on the road. RAM® Mounts can easily be rigged up all around the interior of any RV's or motorhome. Utilize the RAM® Tough-Track™ and drill-down bases to mount applicable devices and household objects to personalize your roadtripping experience. The RAM® Roller-Ball™ can be used as a broom holder while you can also mount a tablet under the cabinets for a home theater experience. RV's are where RAM® Mounts shine with imagination. There truly are no rules when outfitting your vehicle with device mounts.

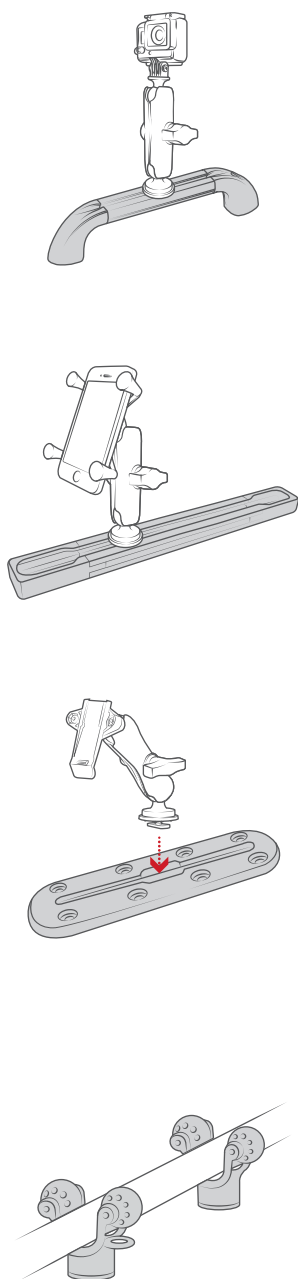

MODULAR ALUMINUM

RAM-TRACK-EXA-9U
9" Modular Aluminum
RAM® Tough-Track™



GO TO PAGE 60
FOR MORE OPTIONS



RAM® HAND-TRACK™

RAM-TRACK-H10U
10" RAM® Hand-Track™
with 16" Overall Length



GO TO PAGE 62
FOR MORE OPTIONS



TOP-LOADING COMPOSITE

RAP-TRACK-A9U
RAM® Tough-Track™ -
Top-Loading Composite
9" Track



GO TO PAGE 62
FOR MORE OPTIONS



RAP-412U
RAM® Roller-Ball™ Accessory Holder



RAP-B-202-GOP1-354-TRA1U
Action Camera Mount



RAP-B-202-GA76-TRA1U
Garmin Spine Clip
Holder Mount



**BEST
SELLER**

RAP-HOL-UN7B-354-TRA1U
RAM® X-Grip® Phone Mount

RAM® NO-DRILL™ VEHICLE FLOOR MOUNT COMPATIBILITY

MAKE	MODEL	YEAR	VEHICLE BASE	LAPTOP MOUNT	TABLET MOUNT (Holder not included. Select any holder from Page 149)
CHEVROLET	ASTRO VAN	2010 - 2011	RAM-VB-136	RAM-VB-136-SW1	RAM-VP-SW1-8 RAM-VB-136
	AVALANCHE	2010 - 2013	RAM-VB-159	RAM-VB-159-SW1	RAM-VP-SW1-89 RAM-VB-159
	CAPRICE POLICE PATROL VEHICLE	2011 - 2013	RAM-VB-189	RAM-VB-189-SW1	RAM-VP-SW1-8 RAM-VB-189
	CITY EXPRESS	2015 - 2017	RAM-VB-159NR	RAM-VB-192-SW1	RAM-VP-SW1-129 RAM-VB-159NR
	COLORADO	2010 - 2011	RAM-VB-116A	RAM-VB-116-SW1	RAM-VP-SW1-89 RAM-VB-116A
		2015 - 2021	RAM-VB-193	RAM-VB-193-SW1	RAM-VB-193-SW2
	EXPRESS VAN	2010 - 2021	RAM-VB-143	RAM-VB-143-SW1	RAM-VP-SW1-8 RAM-VB-143
	G-SERIES VAN	2010 - 2017	RAM-VB-143	RAM-VB-143-SW1	RAM-VP-SW1-8 RAM-VB-143
	IMPALA POLICE PACKAGE	2010 - 2016	RAM-VB-182	RAM-VB-182-SW1	RAM-VP-SW1-89 RAM-VB-182
	SILVERADO 1500	2019 - 2021	RAM-VB-203	RAM-VB-203-SW1	RAM-VB-203-SW2
	SILVERADO 1500 / LD	2010 - 2013	RAM-VB-159	RAM-VB-159-SW1	RAM-VP-SW1-89 RAM-VB-159
		2014 - 2018	RAM-VB-193	RAM-VB-193-SW1	RAM-VB-193-SW2
	SILVERADO 2500 / 3500	2010 - 2013	RAM-VB-159	RAM-VB-159-SW1	RAM-VP-SW1-89 RAM-VB-159
		2014 - 2019	RAM-VB-193	RAM-VB-193-SW1	RAM-VB-193-SW2
		2020 - 2021	RAM-VB-203	RAM-VB-203-SW1	RAM-VB-203-SW2
	SUBURBAN	2010 - 2014	RAM-VB-159	RAM-VB-159-SW1	RAM-VP-SW1-89 RAM-VB-159
		2015 - 2020	RAM-VB-193	RAM-VB-193-SW1	RAM-VB-193-SW2
TAHOE	2010 - 2014	RAM-VB-159	RAM-VB-159-SW1	RAM-VP-SW1-89 RAM-VB-159	
	2015 - 2020	RAM-VB-193	RAM-VB-193-SW1	RAM-VB-193-SW2	
W3500 / W4500	2010 - 2017	RAM-VB-197-SW2NT	RAM-VB-197-SW2	RAM-VB-197-SW2NT	
CHRYSLER	300	2011 - 2021	RAM-VB-129	RAM-VB-129-SW1	RAM-VP-SW1-129 RAM-VB-129
	TOWN AND COUNTRY	2012 - 2016	RAM-VB-175	RAM-VB-175-SW1	RAM-VP-SW1-89 RAM-VB-175
DODGE	C/V TRADESMAN VAN	2014 - 2015	RAM-VB-175	RAM-VB-175-SW1	RAM-VP-SW1-89 RAM-VB-175
	CHARGER (NON-POLICE CAR)	2010	RAM-VB-145	RAM-VB-145-SW1	RAM-VP-SW1-89 RAM-VB-145
		2011 - 2021	RAM-VB-129	RAM-VB-129-SW1	RAM-VP-SW1-129 RAM-VB-129
	CHARGER (POLICE CAR)	2010	RAM-VB-145P	RAM-VB-145P-SW1	RAM-VP-SW1-89 RAM-VB-145P
		2011 - 2021	RAM-VB-129	RAM-VB-129-SW1	RAM-VP-SW1-129 RAM-VB-129
	DURANGO	2011 - 2021	RAM-VB-186	RAM-VB-186-SW1	RAM-VP-SW1-89 RAM-VB-186
	GRAND CARAVAN	2012 - 2016	RAM-VB-175	RAM-VB-175-SW1	RAM-VP-SW1-89 RAM-VB-175
		2017 - 2020	RAM-VB-196	RAM-VB-196-SW1	RAM-VB-196-SW2
JOURNEY	2011 - 2020	RAM-VB-195	RAM-VB-195-SW1	RAM-VB-195-SW2	
SPRINTER VAN	2010 - 2011	RAM-VB-129	RAM-VB-129-SW1	RAM-VP-SW1-129 RAM-VB-129	

RAM® NO-DRILL™ VEHICLE FLOOR MOUNT COMPATIBILITY

MAKE	MODEL	YEAR	VEHICLE BASE	LAPTOP MOUNT	TABLET MOUNT (Holder not included. Select any holder from Page 149)
FORD	C-MAX	2014 - 2018	RAM-VB-195	RAM-VB-195-SW1	RAM-VB-195-SW2
	E-350	2012 - 2017	RAM-VB-119	RAM-VB-119-SW1	RAM-VB-119-INC1
	E-450	2012 - 2017	RAM-VB-119	RAM-VB-119-SW1	RAM-VB-119-INC1
	ECONOLINE VAN	2010 - 2015	RAM-VB-119	RAM-VB-119-SW1	RAM-VB-119-INC1
	EDGE	2010 - 2013	RAM-VB-172	RAM-VB-172-SW1	RAM-VP-SW1-89 RAM-VB-172
		2014 - 2021	RAM-VB-187	RAM-VB-187-SW1	RAM-VP-SW1-129 RAM-VB-187
	ESCAPE	2010 - 2012	RAM-VB-152	RAM-VB-152-SW1	RAM-VP-SW1-89 RAM-VB-152
		2013 - 2019	RAM-VB-195	RAM-VB-195-SW1	RAM-VB-195-SW2
	EXPEDITION	2010 - 2017	RAM-VB-110	RAM-VB-110-SW1	RAM-VP-SW1-89 RAM-VB-110
		2018 - 2021	RAM-VB-195	RAM-VB-195-SW1	RAM-VB-195-SW2
	EXPLORER	2010	RAM-VB-112	RAM-VB-112-SW1	RAM-VP-SW1-45 RAM-VB-112
		2011 - 2019	RAM-VB-187	RAM-VB-187-SW1	RAM-VP-SW1-129 RAM-VB-187
		2020 - 2021	RAM-VB-202-A	RAM-VB-202-A-SW1	RAM-VP-SW1-129 RAM-VB-202-A
	F-150	2010 - 2014	RAM-VB-109A	RAM-VB-109A-SW1	RAM-VP-SW1-89 RAM-VB-109A
		2015 - 2020	RAM-VB-195	RAM-VB-195-SW1	RAM-VB-195-SW2
	F-250 - F-550	2010 - 2016	RAM-VB-185	RAM-VB-185-SW1	RAM-VB-185-SW2
		2017 - 2021	RAM-VB-195	RAM-VB-195-SW1	RAM-VB-195-SW2
	F-650 - F-750	2010 - 2021	RAM-VB-185	RAM-VB-185-SW1	RAM-VB-185-SW2
	FLEX	2010 - 2019	RAM-VB-161R	RAM-VB-161R-SW1	RAM-VP-SW1-47 RAM-VB-161R
	FOCUS	2010	RAM-VB-148	RAM-VB-148-SW1	RAM-VP-SW1-89 RAM-VB-148
		2011 - 2018	RAM-VB-195	RAM-VB-195-SW1	RAM-VB-195-SW2
	FUSION	2010 - 2012	RAM-VB-167	RAM-VB-167-SW1	RAM-VP-SW1-89 RAM-VB-167
		2013 - 2021	RAM-VB-172	RAM-VB-172-SW1	RAM-VP-SW1-89 RAM-VB-172
	POLICE INTERCEPTOR SEDAN	2013 - 2017	RAM-VB-190	RAM-VB-190-SW1	RAM-VP-SW1-47 RAM-VB-190
	POLICE INTERCEPTOR UTILITY	2013 - 2018	RAM-VB-187	RAM-VB-187-SW1	RAM-VP-SW1-129 RAM-VB-187
	RANGER	2019 - 2021	RAM-VB-202	RAM-VB-202-SW1	RAM-VB-202-SW2
	RAPTOR	2015 - 2020	RAM-VB-195	RAM-VB-195-SW1	RAM-VB-195-SW2
	TAURUS	2010 - 2012	RAM-VB-161	RAM-VB-161-SW1	RAM-VP-SW1-47 RAM-VB-161
		2013 - 2017	RAM-VB-190	RAM-VB-190-SW1	RAM-VP-SW1-47 RAM-VB-190
	TRANSIT CONNECT	2010 - 2013	RAM-VB-175	RAM-VB-175-SW1	RAM-VP-SW1-89 RAM-VB-175
2014 - 2021		RAM-VB-195	RAM-VB-195-SW1	RAM-VB-195-SW2	
TRANSIT FULL SIZE VAN	2014 - 2021	RAM-VB-194	RAM-VB-194-SW1	RAM-VB-194-SW2	

RAM® NO-DRILL™ VEHICLE FLOOR MOUNT COMPATIBILITY

MAKE	MODEL	YEAR	VEHICLE BASE	LAPTOP MOUNT	TABLET MOUNT (Holder not included. Select any holder from Page 149)
FREIGHTLINER	SPRINTER VAN	2010 - 2021	RAM-VB-129	RAM-VB-129-SW1	RAM-VP-SW1-129 RAM-VB-129
	GMC	CANYON	2010 - 2012	RAM-VB-116A	RAM-VB-116-SW1
2015 - 2021			RAM-VB-193	RAM-VB-193-SW1	RAM-VB-193-SW2
G-SERIES VAN		2010 - 2016	RAM-VB-143	RAM-VB-143-SW1	RAM-VP-SW1-8 RAM-VB-143
SAVANA VAN		2010 - 2021	RAM-VB-143	RAM-VB-143-SW1	RAM-VP-SW1-8 RAM-VB-143
SIERRA 1500		2010 - 2013	RAM-VB-159	RAM-VB-159-SW1	RAM-VP-SW1-89 RAM-VB-159
		2014 - 2018	RAM-VB-193	RAM-VB-193-SW1	RAM-VB-193-SW2
		2019 - 2021	RAM-VB-203	RAM-VB-203-SW1	RAM-VB-203-SW2
SIERRA 2500 / 3500		2010 - 2014	RAM-VB-159	RAM-VB-159-SW1	RAM-VP-SW1-89 RAM-VB-159
		2015 - 2019	RAM-VB-193	RAM-VB-193-SW1	RAM-VB-193-SW2
		2020 - 2021	RAM-VB-203	RAM-VB-203-SW1	RAM-VB-203-SW2
TOPKICK 4500 / 5500 / 6500 / 7500 / 8500 W3500 / W4500		2010 - 2011	RAM-VB-106	RAM-VB-106-SW1	RAM-VP-SW1-89 RAM-VB-106
		2010 - 2017	RAM-VB-197-SW2NT	RAM-VB-197-SW2	RAM-VB-197-SW2NT
YUKON / YUKON XL		2010 - 2016	RAM-VB-159	RAM-VB-159-SW1	RAM-VP-SW1-89 RAM-VB-159
		2017 - 2020	RAM-VB-193	RAM-VB-193-SW1	RAM-VB-193-SW2
JEEP	CHEROKEE	2014 - 2015	RAM-VB-121	RAM-VB-121-SW1	RAM-VP-SW1-8 RAM-VB-121
	COMPASS	2013 - 2021	RAM-VB-195	RAM-VB-195-SW1	RAM-VB-195-SW2
	GRAND CHEROKEE	2010	RAM-VB-142	RAM-VB-142-SW1	RAM-VP-SW1-89 RAM-VB-142
		2011 - 2021	RAM-VB-186	RAM-VB-186-SW1	RAM-VP-SW1-89 RAM-VB-186
	PATRIOT	2013 - 2017	RAM-VB-195	RAM-VB-195-SW1	RAM-VB-195-SW2
MERCEDES	METRIS	2016 - 2021	RAM-VB-129	RAM-VB-129-SW1	RAM-VP-SW1-129 RAM-VB-129
	SPRINTER VAN	2010 - 2021	RAM-VB-129	RAM-VB-129-SW1	RAM-VP-SW1-129 RAM-VB-129
NISSAN	ARMADA	2010 - 2016	RAM-VB-134	RAM-VB-134-SW1	RAM-VP-SW1-89 RAM-VB-134
	FRONTIER (4X4)	2010 - 2020	RAM-VB-154	RAM-VB-154-SW1	RAM-VP-SW1-89 RAM-VB-154
	NV1500	2011 - 2021	RAM-VB-180	RAM-VB-180-SW1	RAM-VP-SW1-89 RAM-VB-180
	NV200 Series	2010 - 2021	RAM-VB-159NR	RAM-VB-192-SW1	RAM-VP-SW1-129 RAM-VB-159NR
	NV2500 / 3500	2011 - 2020	RAM-VB-180	RAM-VB-180-SW1	RAM-VP-SW1-89 RAM-VB-180
	PATHFINDER	2010 - 2013	RAM-VB-154	RAM-VB-154-SW1	RAM-VP-SW1-89 RAM-VB-154
	TITAN	2010 - 2015	RAM-VB-134	RAM-VB-134-SW1	RAM-VP-SW1-89 RAM-VB-134
	XTERRA (4X4 ONLY)	2010 - 2015	RAM-VB-154	RAM-VB-154-SW1	RAM-VP-SW1-89 RAM-VB-154

RAM® NO-DRILL™ VEHICLE FLOOR MOUNT COMPATIBILITY

MAKE	MODEL	YEAR	VEHICLE BASE	LAPTOP MOUNT	TABLET MOUNT (Holder not included. Select any holder from Page 149)
RAM	1500	2010 - 2018	RAM-VB-178A	RAM-VB-178A-SW1	RAM-VB-178A-SW2
		2019 - 2021	RAM-VB-186ST1	RAM-VB-186ST1-SW1	RAM-VB-186ST1-SW2
	1500 CLASSIC 2500 / 3500 / 4500 / 5500 / CHASSIS CAB	2019 - 2021	RAM-VB-178A	RAM-VB-178A-SW1	RAM-VB-178A-SW2
		2010 - 2021	RAM-VB-178A	RAM-VB-178A-SW1	RAM-VB-178A-SW2
	PROMASTER	2014 - 2021	RAM-VB-129	RAM-VB-129-A-SW1	RAM-VP-SW1-89 RAM-VB-129
	PROMASTER CITY	2017 - 2020	RAM-VB-129	RAM-VB-129-A-SW1	RAM-VP-SW1-89 RAM-VB-129
	PROMASTER CITY WAGON / VAN	2014 - 2016	RAM-VB-129	RAM-VB-129-SW1	RAM-VP-SW1-129 RAM-VB-129
TOYOTA	4RUNNER	2010 - 2021	RAM-VB-138	RAM-VB-138-SW1	RAM-VP-SW1-89 RAM-VB-138
	FJ CRUISER	2010 - 2014	RAM-VB-138ST1	RAM-VB-138ST1-SW1	RAM-VP-SW1-89 RAM-VB-138ST1
	PRIUS	2010 - 2021	RAM-VB-196	RAM-VB-196-SW1	RAM-VB-196-SW2
	PRIUS C	2014 - 2015	RAM-VB-179	RAM-VB-179-SW1	RAM-VP-SW1-89 RAM-VB-179
	RAV4	2010 - 2011	RAM-VB-149	RAM-VB-149-SW1	RAM-VP-SW1-89 RAM-VB-149
	TACOMA	2010 - 2021	RAM-VB-138	RAM-VB-138-SW1	RAM-VP-SW1-89 RAM-VB-138
	TUNDRA	2010 - 2021	RAM-VB-180	RAM-VB-180-SW1	RAM-VP-SW1-89 RAM-VB-180
SEMI TRUCKS	FREIGHTLINER INTERNATIONAL KENWORTH MACK PETERBILT VOLVO	All Years	RAM-VB-168	RAM-VB-168-SW1	RAM-VB-168-SW2

TABLET HOLDER COMPATIBILITY

MAKE	MODEL	WITH CASE?	RAM® X-GRIP®	RAM® TAB-TITE™	RAM® TAB-LOCK™	RAM® EZ-ROLL'R™
APPLE	iPad (3 rd Gen)	No	RAM-HOL-UN9U	RAM-HOL-TAB3U	RAM-HOL-TABL3U	RAM-HOL-AP15U
		Yes	RAM-HOL-UN9U	RAM-HOL-TAB17U	RAM-HOL-TABL17U	-
	iPad (4 th Gen)	No	RAM-HOL-UN9U	RAM-HOL-TAB3U	RAM-HOL-TABL3U	RAM-HOL-AP15U
		Yes	RAM-HOL-UN9U	RAM-HOL-TAB17U	RAM-HOL-TABL17U	-
	iPad (5 th Gen)	No	RAM-HOL-UN9U	RAM-HOL-TAB28U	RAM-HOL-TABL28U	RAM-HOL-AP17U
		Yes	RAM-HOL-UN9U	RAM-HOL-TAB20U	RAM-HOL-TABL20U	-
	iPad (6 th Gen)	No	RAM-HOL-UN9U	RAM-HOL-TAB28U	RAM-HOL-TABL28U	RAM-HOL-AP17U
		Yes	RAM-HOL-UN9U	RAM-HOL-TAB20U	RAM-HOL-TABL20U	-
	iPad (7 th Gen)	No	RAM-HOL-UN9U	RAM-HOL-TAB26U	RAM-HOL-TABL26U	RAM-HOL-AP31U
		Yes	RAM-HOL-UN9U	RAM-HOL-TAB20U	RAM-HOL-TABL20U	-
	iPad (8 th Gen)	No	RAM-HOL-UN9U	RAM-HOL-TAB26U	RAM-HOL-TABL26U	RAM-HOL-AP31U
		Yes	RAM-HOL-UN9U	RAM-HOL-TAB20U	RAM-HOL-TABL20U	-
	iPad Air	No	RAM-HOL-UN9U	RAM-HOL-TAB6U	RAM-HOL-TABL6U	RAM-HOL-AP17U
		Yes	RAM-HOL-UN9U	RAM-HOL-TAB20U	RAM-HOL-TABL20U	-
	iPad Air 2	No	RAM-HOL-UN9U	RAM-HOL-TAB6U	RAM-HOL-TABL6U	RAM-HOL-AP17U
		Yes	RAM-HOL-UN9U	RAM-HOL-TAB20U	RAM-HOL-TABL20U	-
	iPad Air 3	No	RAM-HOL-UN9U	RAM-HOL-TAB26U	RAM-HOL-TABL26U	RAM-HOL-AP22U
		Yes	RAM-HOL-UN9U	RAM-HOL-TAB20U	RAM-HOL-TABL20U	-
	iPad Air 4	No	RAM-HOL-UN9U	RAM-HOL-TAB3U	RAM-HOL-TABL3U	RAM-HOL-AP23U
		Yes	RAM-HOL-UN9U	RAM-HOL-TAB17U	RAM-HOL-TABL17U	-
	iPad mini 2	No	RAM-HOL-UN8BCU	RAM-HOL-TAB27U	RAM-HOL-TABL27U	RAM-HOL-AP14U
		Yes	RAM-HOL-UN8BCU	RAM-HOL-TAB29U	RAM-HOL-TABL29U	-
	iPad mini 3	No	RAM-HOL-UN8BCU	RAM-HOL-TAB27U	RAM-HOL-TABL27U	RAM-HOL-AP14U
		Yes	RAM-HOL-UN8BCU	RAM-HOL-TAB29U	RAM-HOL-TABL29U	-
	iPad mini 4	No	RAM-HOL-UN8BCU	RAM-HOL-TAB30U	RAM-HOL-TABL30U	RAM-HOL-AP20U
		Yes	RAM-HOL-UN8BCU	RAM-HOL-TAB29U	RAM-HOL-TABL29U	-
	iPad mini 5	No	RAM-HOL-UN8BCU	RAM-HOL-TAB30U	RAM-HOL-TABL30U	RAM-HOL-AP20U
		Yes	RAM-HOL-UN8BCU	RAM-HOL-TAB29U	RAM-HOL-TABL29U	-
	iPad Pro 9.7	No	RAM-HOL-UN9U	RAM-HOL-TAB28U	RAM-HOL-TABL28U	RAM-HOL-AP17U
		Yes	RAM-HOL-UN9U	RAM-HOL-TAB20U	RAM-HOL-TABL20U	-
	iPad Pro 10.5	No	RAM-HOL-UN9U	RAM-HOL-TAB26U	RAM-HOL-TABL26U	RAM-HOL-AP22U
		Yes	RAM-HOL-UN9U	RAM-HOL-TAB20U	RAM-HOL-TABL20U	-
iPad Pro 11"	No	RAM-HOL-UN9U	RAM-HOL-TAB3U	RAM-HOL-TABL3U	RAM-HOL-AP23U	
	Yes	RAM-HOL-UN9U	RAM-HOL-TAB17U	RAM-HOL-TABL17U	-	
iPad Pro 11" (2020)	No	RAM-HOL-UN9U	RAM-HOL-TAB3U	RAM-HOL-TABL3U	RAM-HOL-AP23U	
	Yes	RAM-HOL-UN9U	RAM-HOL-TAB17U	RAM-HOL-TABL17U	-	
iPad Pro 12.9 (1 st Gen)	No	RAM-HOL-UN11U	-	-	RAM-HOL-AP21U	
iPad Pro 12.9 (2 nd Gen)	No	RAM-HOL-UN11U	-	-	RAM-HOL-AP21U	
iPad Pro 12.9 (3 rd Gen)	No	RAM-HOL-UN11U	-	-	RAM-HOL-AP24U	
iPad Pro 12.9 (4 th Gen)	No	RAM-HOL-UN11U	-	-	RAM-HOL-AP24U	

TABLET HOLDER COMPATIBILITY

MAKE	MODEL	WITH CASE?	RAM® X-GRIP®	RAM® TAB-TITE™	RAM® TAB-LOCK™	RAM® EZ-ROLL'R™	
MICROSOFT	Surface Go	No	RAM-HOL-UN9-DFSU	RAM-HOL-TAB26U	RAM-HOL-TABL26U	-	
		Yes	RAM-HOL-UN9-DFSU	RAM-HOL-TAB20U	RAM-HOL-TABL20U	-	
	Surface Go 2	No	RAM-HOL-UN9-DFSU	RAM-HOL-TAB26U	RAM-HOL-TABL26U	-	
		Yes	RAM-HOL-UN9-DFSU	RAM-HOL-TAB20U	RAM-HOL-TABL20U	-	
	Surface Pro 4	No	RAM-HOL-UN11U	-	-	-	
	Surface Pro 5	No	RAM-HOL-UN11U	-	-	-	
	Surface Pro 6	No	RAM-HOL-UN11U	-	-	-	
	Surface Pro 7	No	RAM-HOL-UN11U	-	-	-	
Surface Pro X	No	RAM-HOL-UN11U	-	-	-		
SAMSUNG	Galaxy Tab 10.1	No	RAM-HOL-UN9U	RAM-HOL-TAB26U	RAM-HOL-TABL26U	RAM-HOL-SAM5U	
		Yes	RAM-HOL-UN9U	RAM-HOL-TAB20U	RAM-HOL-TABL20U	-	
	Galaxy Tab 4 10.1	No	RAM-HOL-UN9U	RAM-HOL-TAB26U	RAM-HOL-TABL26U	-	
		Yes	RAM-HOL-UN9U	RAM-HOL-TAB25U	RAM-HOL-TABL25U	-	
	Galaxy Tab A 10.1 (2019)	No	n/a	RAM-HOL-TAB29U	RAM-HOL-TABL29U	-	
		Yes	n/a	RAM-HOL-TAB25U	RAM-HOL-TABL25U	-	
	Galaxy Tab A 10.5	No	RAM-HOL-UN9U	RAM-HOL-TAB28U	RAM-HOL-TABL28U	-	
		Yes	RAM-HOL-UN9U	RAM-HOL-TAB20U	RAM-HOL-TABL20U	-	
	Galaxy Tab A 7.0	No	RAM-HOL-UN8BCU	RAM-HOL-TAB5U	RAM-HOL-TABL18U	-	
		Yes	RAM-HOL-UN8BCU	RAM-HOL-TAB4U	RAM-HOL-TABL4U	-	
	Galaxy Tab A 8.0 (2017)	No	RAM-HOL-UN8BU	RAM-HOL-TAB24U	RAM-HOL-TABL24U	-	
		Yes	RAM-HOL-UN8BCU	RAM-HOL-TAB12U	RAM-HOL-TABL12U	-	
	Galaxy Tab A 8.0 (2018)	No	RAM-HOL-UN8BU	RAM-HOL-TAB24U	RAM-HOL-TABL24U	-	
		Yes	RAM-HOL-UN8BCU	RAM-HOL-TAB12U	RAM-HOL-TABL12U	-	
	Galaxy Tab A 8.0 (2019)	No	RAM-HOL-UN8BU	RAM-HOL-TAB24U	RAM-HOL-TABL24U	-	
		Yes	RAM-HOL-UN8BCU	RAM-HOL-TAB12U	RAM-HOL-TABL12U	-	
	Galaxy Tab A 8.4	No	RAM-HOL-UN8BU	RAM-HOL-TAB24U	RAM-HOL-TABL24U	-	
		Yes	RAM-HOL-UN8BCU	RAM-HOL-TAB12U	RAM-HOL-TABL12U	-	
	Galaxy Tab Active Pro	See Page 100 For Tab Active Pro, Tab Active2 & Tab Active3 Compatibility					
	Galaxy Tab Active2						
	Galaxy Tab Active3						
	Galaxy Tab E 8.0	No	RAM-HOL-UN8BCU	RAM-HOL-TAB24U	RAM-HOL-TABL24U	-	
		Yes	RAM-HOL-UN8BCU	RAM-HOL-TAB12U	RAM-HOL-TABL12U	-	
	Galaxy Tab E 9.6	No	n/a	RAM-HOL-TAB31U	RAM-HOL-TABL31U	-	
		Yes	n/a	RAM-HOL-TAB25U	RAM-HOL-TABL25U	-	
	Galaxy Tab S2 9.7	No	RAM-HOL-UN9U	RAM-HOL-TAB28U	RAM-HOL-TABL28U	-	
		Yes	RAM-HOL-UN9U	RAM-HOL-TAB20U	RAM-HOL-TABL20U	-	
	Galaxy Tab S4 10.5"	No	RAM-HOL-UN9U	RAM-HOL-TAB28U	RAM-HOL-TABL28U	-	
		Yes	RAM-HOL-UN9U	RAM-HOL-TAB20U	RAM-HOL-TABL20U	-	
	Galaxy Tab S5e	No	RAM-HOL-UN9U	-	-	-	
		Yes	RAM-HOL-UN9U	-	-	-	
	Galaxy Tab S6	No	RAM-HOL-UN9U	RAM-HOL-TAB28U	RAM-HOL-TABL28U	-	
Yes		RAM-HOL-UN9U	RAM-HOL-TAB20U	RAM-HOL-TABL20U	-		
Galaxy Tab S7	No	RAM-HOL-UN9U	RAM-HOL-TAB28U	RAM-HOL-TABL28U	-		
	Yes	RAM-HOL-UN9U	RAM-HOL-TAB20U	RAM-HOL-TABL20U	-		
Galaxy Tab S7 +	No	RAM-HOL-UN9U	-	-	-		
	Yes	RAM-HOL-UN9U	-	-	-		

PHONE HOLDER COMPATIBILITY

MAKE	MODEL	WITH CASE?	RAM® X-GRIP®	RAM® QUICK-GRIP™	FORM-FIT (BALL NOT INCLUDED)	RAM® TOUGH-CHARGE™ (WIRELESS CHARGER)	RAM® QUICK-GRIP™ (WIRELESS CHARGER)
APPLE	iPhone 11	No	RAM-HOL-UN7BU	RAM-HOL-PD4-238AU	RAM-HOL-AP26U	RAM-HOL-UN12WB	RAM-HOL-UN14WB
		Yes	RAM-HOL-UN10BU	RAM-HOL-PD4-238AU	-	RAM-HOL-UN12WB	-
	iPhone 11 Pro	No	RAM-HOL-UN7BU	RAM-HOL-PD3-238AU	-	RAM-HOL-UN12WB	RAM-HOL-UN14WB
		Yes	RAM-HOL-UN7BU	RAM-HOL-PD3-238AU	-	RAM-HOL-UN12WB	RAM-HOL-UN14WB
	iPhone 11 Pro Max	No	RAM-HOL-UN10BU	RAM-HOL-PD4-238AU	-	RAM-HOL-UN12WB	RAM-HOL-UN14WB
		Yes	RAM-HOL-UN10BU	RAM-HOL-PD4-238AU	-	RAM-HOL-UN12WB	-
	iPhone 12	No	RAM-HOL-UN7BU	RAM-HOL-PD4-238AU	RAM-HOL-AP33U	RAM-HOL-UN12WB	RAM-HOL-UN14WB
		Yes	RAM-HOL-UN7BU	RAM-HOL-PD4-238AU	-	RAM-HOL-UN12WB	RAM-HOL-UN14WB
	iPhone 12 mini	No	RAM-HOL-UN7BU	RAM-HOL-PD3-238AU	RAM-HOL-AP34U	RAM-HOL-UN12WB	-
		Yes	RAM-HOL-UN7BU	RAM-HOL-PD3-238AU	-	RAM-HOL-UN12WB	-
	iPhone 12 Pro	No	RAM-HOL-UN7BU	RAM-HOL-PD4-238AU	RAM-HOL-AP33U	RAM-HOL-UN12WB	RAM-HOL-UN14WB
		Yes	RAM-HOL-UN7BU	RAM-HOL-PD4-238AU	-	RAM-HOL-UN12WB	RAM-HOL-UN14WB
	iPhone 12 Pro Max	No	RAM-HOL-UN10BU	RAM-HOL-PD4-238AU	RAM-HOL-AP35U	RAM-HOL-UN12WB	RAM-HOL-UN14WB
		Yes	RAM-HOL-UN10BU	RAM-HOL-PD4-238AU	-	RAM-HOL-UN12WB	-
	iPhone 6s	No	RAM-HOL-UN7BU	RAM-HOL-PD3-238AU	RAM-HOL-AP18U	-	-
		Yes	RAM-HOL-UN7BU	RAM-HOL-PD3-238AU	-	-	-
	iPhone 6s Plus	No	RAM-HOL-UN10BU	RAM-HOL-PD4-238AU	RAM-HOL-AP19U	-	-
		Yes	RAM-HOL-UN10BU	n/a	-	-	-
	iPhone 7	No	RAM-HOL-UN7BU	RAM-HOL-PD3-238AU	RAM-HOL-AP18U	-	-
		Yes	RAM-HOL-UN7BU	RAM-HOL-PD3-238AU	-	-	-
	iPhone 7 Plus	No	RAM-HOL-UN10BU	RAM-HOL-PD4-238AU	RAM-HOL-AP19U	-	-
		Yes	RAM-HOL-UN10BU	RAM-HOL-PD4-238AU	-	-	-
	iPhone 8	No	RAM-HOL-UN7BU	RAM-HOL-PD3-238AU	-	RAM-HOL-UN12WB	RAM-HOL-UN14WB
		Yes	RAM-HOL-UN7BU	RAM-HOL-PD3-238AU	-	RAM-HOL-UN12WB	RAM-HOL-UN14WB
	iPhone 8 Plus	No	RAM-HOL-UN10BU	RAM-HOL-PD4-238AU	-	RAM-HOL-UN12WB	RAM-HOL-UN14WB
		Yes	RAM-HOL-UN10BU	RAM-HOL-PD4-238AU	-	RAM-HOL-UN12WB	-
	iPhone SE	No	RAM-HOL-UN7BU	RAM-HOL-PD3-238AU	-	RAM-HOL-UN12WB	RAM-HOL-UN14WB
		Yes	RAM-HOL-UN7BU	RAM-HOL-PD3-238AU	-	RAM-HOL-UN12WB	RAM-HOL-UN14WB
	iPhone X	No	RAM-HOL-UN7BU	RAM-HOL-PD3-238AU	-	RAM-HOL-UN12WB	RAM-HOL-UN14WB
		Yes	RAM-HOL-UN7BU	RAM-HOL-PD4-238AU	-	RAM-HOL-UN12WB	RAM-HOL-UN14WB
iPhone Xr	No	RAM-HOL-UN7BU	RAM-HOL-PD4-238AU	RAM-HOL-AP26U	RAM-HOL-UN12WB	RAM-HOL-UN14WB	
iPhone Xr	Yes	RAM-HOL-UN10BU	RAM-HOL-PD4-238AU	-	RAM-HOL-UN12WB	-	
iPhone Xs	No	RAM-HOL-UN7BU	RAM-HOL-PD3-238AU	-	RAM-HOL-UN12WB	RAM-HOL-UN14WB	
iPhone Xs	Yes	RAM-HOL-UN7BU	RAM-HOL-PD4-238AU	-	RAM-HOL-UN12WB	RAM-HOL-UN14WB	
iPhone Xs Max	No	RAM-HOL-UN10BU	RAM-HOL-PD4-238AU	RAM-HOL-AP19U	RAM-HOL-UN12WB	RAM-HOL-UN14WB	
	Yes	RAM-HOL-UN10BU	RAM-HOL-PD4-238AU	-	RAM-HOL-UN12WB	-	

PHONE HOLDER COMPATIBILITY

MAKE	MODEL	WITH CASE?	RAM® X-GRIP®	RAM® QUICK-GRIP™	FORM-FIT (BALL NOT INCLUDED)	RAM® TOUGH-CHARGE™ (WIRELESS CHARGER)	RAM® QUICK-GRIP™ (WIRELESS CHARGER)	
GOOGLE	Pixel 3	No	RAM-HOL-UN7BU	RAM-HOL-PD3-238AU	-	RAM-HOL-UN12WB	RAM-HOL-UN14WB	
		Yes	RAM-HOL-UN7BU	RAM-HOL-PD4-238AU	-	RAM-HOL-UN12WB	RAM-HOL-UN14WB	
	Pixel 3 XL	No	RAM-HOL-UN10BU	RAM-HOL-PD4-238AU	-	RAM-HOL-UN12WB	RAM-HOL-UN14WB	
		Yes	RAM-HOL-UN10BU	n/a	-	RAM-HOL-UN12WB	-	
	Pixel 4	No	RAM-HOL-UN7BU	RAM-HOL-PD4-238AU	-	RAM-HOL-UN12WB	RAM-HOL-UN14WB	
		Yes	RAM-HOL-UN7BU	RAM-HOL-PD4-238AU	-	RAM-HOL-UN12WB	RAM-HOL-UN14WB	
	Pixel 4 XL	No	RAM-HOL-UN7BU	RAM-HOL-PD4-238AU	-	RAM-HOL-UN12WB	RAM-HOL-UN14WB	
		Yes	RAM-HOL-UN7BU	RAM-HOL-PD4-238AU	-	RAM-HOL-UN12WB	-	
	SAMSUNG	Galaxy Note 10	No	RAM-HOL-UN7BU	RAM-HOL-PD4-238AU	-		
			Yes	RAM-HOL-UN7BU	RAM-HOL-PD4-238AU	-		
Galaxy Note 10 Plus		No	RAM-HOL-UN10BU	RAM-HOL-PD4-238AU	-			
		Yes	RAM-HOL-UN10BU	n/a	-			
Galaxy Note 8		No	RAM-HOL-UN7BU	RAM-HOL-PD4-238AU	-			
		Yes	RAM-HOL-UN10BU	RAM-HOL-PD4-238AU	-			
Galaxy Note 9		No	RAM-HOL-UN10BU	RAM-HOL-PD4-238AU	-			
		Yes	RAM-HOL-UN10BU	n/a	-			
Galaxy Note20		No	RAM-HOL-UN7BU	RAM-HOL-PD4-238AU	-			
		Yes	RAM-HOL-UN10BU	RAM-HOL-PD4-238AU	-			
Galaxy Note20 Ultra		No	RAM-HOL-UN10BU	RAM-HOL-PD4-238AU	-			
		Yes	RAM-HOL-UN10BU	RAM-HOL-PD4-238AU	-			
Galaxy S10		No	RAM-HOL-UN7BU	RAM-HOL-PD4-238AU	-			
		Yes	RAM-HOL-UN7BU	RAM-HOL-PD4-238AU	-			
Galaxy S10+		No	RAM-HOL-UN7BU	RAM-HOL-PD4-238AU	-			
		Yes	RAM-HOL-UN10BU	RAM-HOL-PD4-238AU	-			
Galaxy S10e		No	RAM-HOL-UN7BU	RAM-HOL-PD3-238AU	-			
		Yes	RAM-HOL-UN7BU	RAM-HOL-PD4-238AU	-			
Galaxy S20		No	RAM-HOL-UN7BU	RAM-HOL-PD4-238AU	-			
		Yes	RAM-HOL-UN7BU	RAM-HOL-PD4-238AU	-			
Galaxy S20 Ultra 5G		No	RAM-HOL-UN7BU	RAM-HOL-PD4-238AU	-			
		Yes	RAM-HOL-UN10BU	RAM-HOL-PD4-238AU	-			
Galaxy S20+		No	RAM-HOL-UN7BU	RAM-HOL-PD4-238AU	-			
		Yes	RAM-HOL-UN10BU	RAM-HOL-PD4-238AU	-			
Galaxy S7		No	RAM-HOL-UN7BU	RAM-HOL-PD3-238AU	-			
		Yes	RAM-HOL-UN7BU	RAM-HOL-PD4-238AU	-			
Galaxy S8		No	RAM-HOL-UN7BU	RAM-HOL-PD4-238AU	-			
		Yes	RAM-HOL-UN7BU	RAM-HOL-PD4-238AU	-			
Galaxy S8+		No	RAM-HOL-UN7BU	RAM-HOL-PD4-238AU	-			
		Yes	RAM-HOL-UN7BU	RAM-HOL-PD4-238AU	-			
Galaxy S9	No	RAM-HOL-UN7BU	RAM-HOL-PD4-238AU	-				
	Yes	RAM-HOL-UN7BU	RAM-HOL-PD4-238AU	-				
Galaxy S9+	No	RAM-HOL-UN7BU	RAM-HOL-PD4-238AU	-				
	Yes	RAM-HOL-UN7BU	RAM-HOL-PD4-238AU	-				
Galaxy XCover FieldPro	No	RAM-HOL-UN10BU	RAM-HOL-PD4-238AU	RAM-HOL-SAM72PU				
	Yes	RAM-HOL-UN10BU	-	-				
Galaxy Xcover Pro	No	RAM-HOL-UN10BU	RAM-HOL-PD4-238AU	RAM-HOL-SAM9PU - Powered RAM-HOL-SAM59U - Non-Powered				
Galaxy Xcover Pro	Yes	RAM-HOL-UN10BU	-	-				

SEEN IN THIS PHOTO:

RAM-B-102-AP-MAGU
RAM® Drill-Down Mount with
Apple MagSafe Adapter



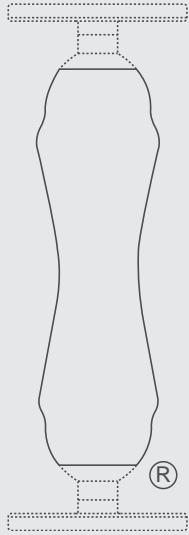

THE SHAPE THAT STARTED IT ALL

RAM® double socket arms with their distinctive Hourglass Shape are recognized globally as a symbol of the reliability, quality, and durability of this line of products. The Hourglass Shape is a registered trademark of National Products Inc.



LEARN MORE

The unique RAM® Mounts system offers a full line of interchangeable mounting bases, extensions, device adapters, and accessories to secure your devices where you want it. See all of the innovative products and solutions RAM® manufactures at rammount.com.

RAM® Mounts is a division of National Products Inc.
 8410 Dallas Avenue South
 Seattle, WA 98108
 Phone: 800.497.7479
sales@rammount.com
rammount.com

Lifetime Warranty
 Patents and Trademarks
rammount.com/ip



THE DISTINCTIVE "D" PRODUCT SHAPE

of the GDS® connector is a trademark of National Products Inc.



THE DISTINCTIVE RAM® "X-GRIP®"

product shape is a trademark of National Products Inc.



Look for the highly recognizable "Double Delta" trademark, the symbol of quality and reliability



CONTACT US

sales@rammount.com
1-800-497-7479

JOIN OUR COMMUNITY



NPI-CAT-ONROAD21
February 2021

