



National Products Inc.

2022 | APPLE MOUNTING SOLUTIONS



Field Service . Healthcare . Manufacturing . Retail . Transportation . Warehouse



SEEN IN THIS PHOTO:

RAM-HOL-UN14WB

RAM® Quick-Grip™ Waterproof Wireless Charging Holder with Ball

RAM-B-201U-C

RAM® Double Socket Arm

RAM-B-224-1U

RAM® Twist-Lock™ Suction Cup Base with Ball

Table of Contents

03 New Products

05 About RAM® Mounts

07 How It Works

09 iPhone 13 Series

11 iPad mini 6

15 iPad 10.2 (9th Gen)

17 iPhone Holders

- 17 RAM® X-Grip®
 - 19 RAM® X-Grip® Low Profile Mounts
 - 21 RAM® Quick-Grip®
 - 23 RAM® Quick-Grip® for Apple MagSafe Compatible Phone
 - 25 Apple MagSafe Adapter
-

27 iPad Holders

- 27 RAM® EZ-Roll'r™
 - 29 RAM® X-Grip® for iPads
 - 31 RAM® Tab-Tite™ & Tab-Lock™
-

33 RAM® iPad Mounts

- 33 Double Ball Mounts
 - 35 RAM® No-Drill™
-

37 IntelliSkin® & IntelliSkin® Next Gen

39 GDS® Vehicle Docks

41 GDS® Desktop Docks

45 GDS® Ergo™

47 Accessories

- 47 RAM® Universal Hand-Stand™
-

49 OtterBox uniVERSE

- 49 Solutions for iPad
 - 51 Solutions for iPhone
-

53 iPad + Keyboard Solutions

55 Compatibility Charts

- 55 iPhone Holder Compatibility
- 56 iPad Holder Compatibility

SEEN IN THIS PHOTO:

RAP-B-299-4-AP-MAGU

RAM® Stubby™ Cup Holder Mount
with Apple MagSafe Adapter



New Products



RAM-HOL-AP38BU

RAM® Form-Fit Holder for Apple iPhone 13, 13 Pro, 14 & 14 Pro with Ball



RAM-HOL-AP39BU

RAM® Form-Fit Holder for iPhone 13 Pro Max, 14 Plus & Pro Max with Ball



RAM-HOL-UN15WBU

RAM® Quick-Grip™ Holder with Ball for Apple MagSafe Compatible Phones



RAM-B-166-UN15WU

RAM® Quick-Grip™ Suction Cup Mount for Apple MagSafe Compatible Phones



RAP-B-202-AP-MAGU

RAM® Ball Adapter



RAM-B-166-AP-MAGU

RAM® Twist-Lock™ Suction Cup Mount



RAP-B-378-AP-MAGU

RAM® Flex Adhesive Double Ball Mount



RAM-B-102-AP-MAGU

RAM® Drill-Down Mount



RAP-B-299-4-AP-MAGU

RAM® Stubby™ Cup Holder Mount



RAM-SB-180-AP-MAGU

RAM® Lil Buddy™ Adhesive Dash Mount



RAM-HS1U

RAM® Universal Hand-Stand™ for 7"-8" Tablets



RAM-HS2U

RAM® Universal Hand-Stand™ for 9"-13" Tablets



RAM-GDS-SKIN-AP36-NG

IntelliSkin® Next Gen for Apple iPad mini 6



RAM-HOL-AP36U

RAM® EZ-Roll™ Cradle for Apple iPad mini 6



RAM-GDS-SKIN-AP37-NG

IntelliSkin® Next Gen for Apple iPad Pro 12.9 3rd - 5th Gen



RAM-GDS-DOCK-AP37CD2U

GDS® Tough-Dock™ + Dual USB for iPad Pro 12.9 3rd - 5th Gen



RAM-GDS-DOCKL-AP32CD2U

Locking GDS® Tough-Dock™ + Dual USB for iPad Air 4 & iPad Pro 11"



RAM-GDS-DOCKL-V10-OMT3CD2U

GDS® Vehicle Dock for iPad mini 6 with Single or Dual Peripheral



VISIT RAMMOUNT.COM/NEW TO SEE ALL NEW RAM® AND GDS® PRODUCTS



About RAM® Mounts

RAM® Mounts manufactures rugged and versatile mounting systems for phones, tablets, and other mobile devices that can be attached nearly anywhere. Unlike other mounts on the market, RAM® allows you to secure devices where you need them most. The unique design of the RAM® Mounts system provides quick installation, adjustability, strength, vibration damping, and durability—all at a low cost. Backed by a lifetime warranty, RAM® uses powder-coated, marine-grade aluminum with lightweight and high-strength composites, stainless steel hardware, and rubber balls.

The RAM® Difference



Premium Design

The rubber ball and socket design of our mounting systems offers a secure hold, with near-infinite adjustability and vibration damping for the most demanding environments. With thousands of components trusted by users around the world, we've been able to design and develop mounting solutions that consumers and companies previously only dreamed were possible.

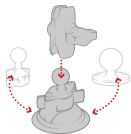

Customizable

Take your phone mount from your truck to your boat, or mix and match components to create your ideal mount. Because of the modularity of the RAM® system, you can customize your solution to fit your specific needs in almost any application.

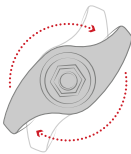

Quality Materials

A premium design deserves the highest quality materials available, from rubber and stainless steel to high-strength composites and marine-grade aluminum. Our facilities—including powder coating, die casting, rubber injection molding, and shock and vibration testing—help us deliver on this promise to bring you inventive mounting solutions.

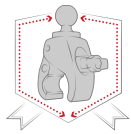

Lifetime Warranty

It's simple. Our reputation as the leader of premier mounting systems means if we build it, then we guarantee it. We're confident in the quality of our products, and with our warranty, you can be too.

*1-3 year warranty on electronics, including powered docks

National Products Inc. (NPI)

Introduced in 1990, National Products Inc. (NPI) quickly became the leading manufacturer of rugged and versatile mounting solutions. RAM® Mounts has grown to offer approximately 5,000 modular components—the most innovative product line of its kind for nearly any application and device, including phones, tablets, GPS systems, laptops, marine electronics, printers, radios, and much more.

In addition to RAM® Mounts, NPI is also the creator of award-winning IntelliSkin® sleeves and GDS® Technology™ products. IntelliSkin® sleeves ruggedize a wide range of consumer phones and tablets, while the GDS® Ecosystem™ provides users the ability to securely charge, dock, and sync devices in the most demanding environments.

NPI is proudly located in Seattle, Washington in the same neighborhood where the company was started.

Partner with RAM® Mounts

Here at RAM® Mounts, we believe that unfathomable things are possible with ingenuity. With a portfolio of more than 5,000 SKUs paired with innovative engineers and in-house product experts, we have the tools and expertise needed to create solutions that you didn't know were possible. We have the ability to solve your mounting challenges quickly, efficiently, and cost effectively.

How It Works

RAM® Phone Mounts

Take your iPhone almost anywhere with RAM® mounting solutions. Choose from a wide selection of bases to attach your iPhone to your car, boat, bike, motorcycle, and much more. All RAM® iPhone holders—including the popular RAM® X-Grip®, RAM® Quick-Grip™, and form-fit holders – provide access to your device's ports and buttons.

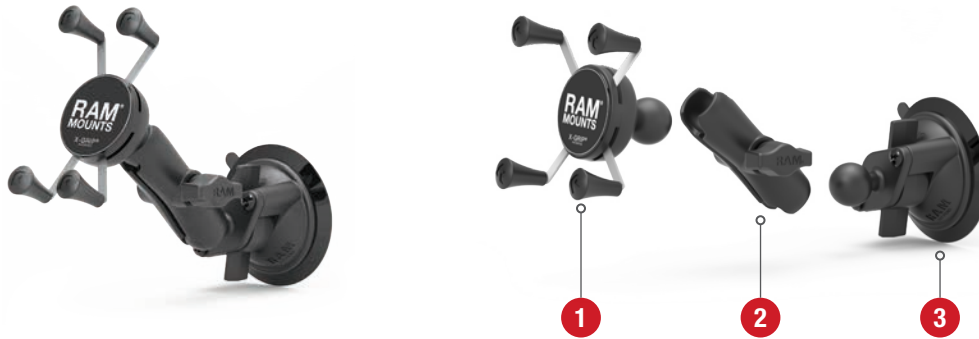

1

Choose a Holder

RAM® offers a wide selection of holders for your specific device

2

Choose an Arm

Select an arm based on your desired length and placement

3

Choose a Base

Select from a variety of bases to help secure your device where you need it

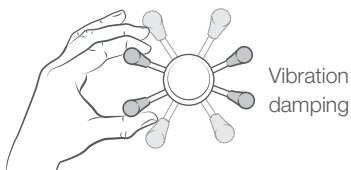

Vibration damping

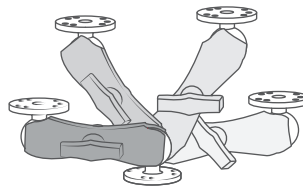

Double ball and socket technology allows for near-infinite adjustability of your RAM® mounting system



Highly adjustable

1 Choose a Holder



RAM-HOL-AP39BU

RAM® Form-Fit Holder for iPhone 13 Pro Max, 14 Plus & Pro Max with Ball



RAM-HOL-UN7BU

RAM® X-Grip® Universal Phone Holder with Ball



RAM-HOL-UN10BU

RAM® X-Grip® Large Phone Holder with Ball



RAM-HOL-PD3-238AU

RAM® Quick-Grip™ Universal Phone Holder with Ball



RAM-HOL-UN15WBU

RAM® Quick-Grip™ Holder with Ball for Apple MagSafe, fits entire iPhone 12 Series



RAP-B-202-AP-MAGU

RAM® Ball Adapter for Apple MagSafe

How It Works Continued

2 Choose a Double Socket Arm

For holders with a ball



RAM-B-201U-A
Short Arm



RAM-B-201U
Medium Arm



RAM-B-201U-C
Long Arm

For holders without a ball



RAM-B-103-A-238U
Short Arm



RAM-B-103-238U
Medium Arm



RAM-B-103-C-238U
Long Arm

3 Choose a Base



RAM-B-202U
Drill-Down Base



RAP-B-400U
RAM® Tough-Claw™



RAP-B-354U-TRA1
RAM® Track Ball™



RAM-B-MAG66U
RAM® Tough-Mag™



RAM-B-108BU
Hose Clamp Base



RAM-B-247U-3
Square Post
Clamp Base

Car/Truck Mounts



RAM-B-166U
Windshield Mount



RAM-B-138U
RAM® Double Ball Drill-Down
Mount with Diamond Plate



RAP-B-299-4-238U
Cup Holder Mount



RAP-B-378-238U
Adhesive Mount

Motorcycle Mounts



RAM-B-149ZU-A
U-Bolt Handlebar Mount



RAM-B-174U
Brake/Clutch Reservoir Mount



RAM-B-176U
Fork Stem Mount



RAM-B-408-75-1-A-238U
RAM® Torque™ Handlebar Mount

Form-Fit



Camera Exposed

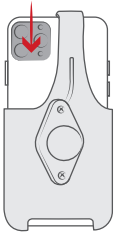

Price
\$

Without Case



One-Handed Operation

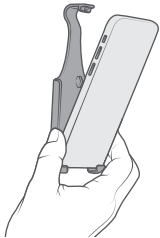

No Assembly

No Low Profile Options



RAM® Quick-Grip®



Camera Blocked
Depending on Model

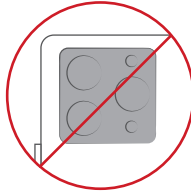

Price
\$\$

With or Without Case



One-Handed Operation

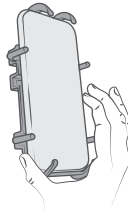

Assembly 

No Low Profile Options



RAM® X-Grip®



Camera Exposed
*Without Tether

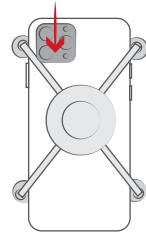

Price
\$\$\$

With or Without Case



Two-Handed Operation

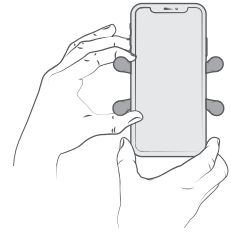

No Assembly

Low Profile Options



See page 19 & 20 for Kits Available

Features

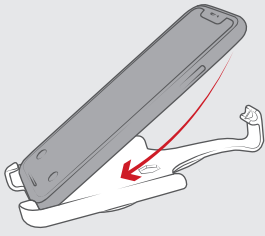

Designed for one-handed docking and removal of device providing a perfect fit without a case

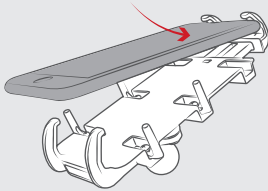

Spring-loaded top grip keeps device in place

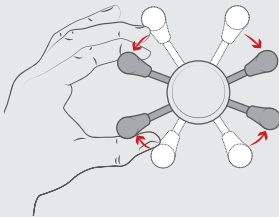

RAM® X-Grip® phone holder features an 'X' design that expands and contracts to provide a perfect fit for your device – even if it's in a case

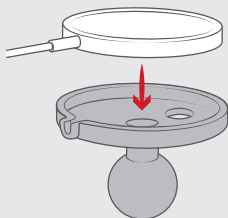

Press-fit design to hold Apple MagSafe charger in place

iPhone 13 Series

For the newest iPhone models, RAM® Mounts has multiple phone holder options from form-fitting designs to universal fitment. If you're rocking an iPhone without a case, our form-fit cradles for iPhone 13 models fit perfectly, are low cost, and low profile. For all other situations, our RAM® X-Grip® and RAM® Quick-Grip™ holders are designed to hold your iPhone 13 with any case on it.

Form-Fit



RAM-HOL-AP34U
Fits iPhone 13 mini



RAM-HOL-AP35U
Fits iPhone 13 Pro Max

RAM® Quick-Grip®



RAM-HOL-PD3-238AU
Fits iPhone 13 mini

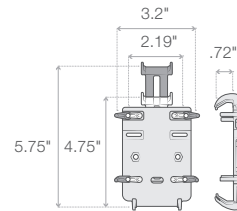

RAM-HOL-PD4-238AU
Fits iPhone 13, 13 Pro & 13 Pro Max

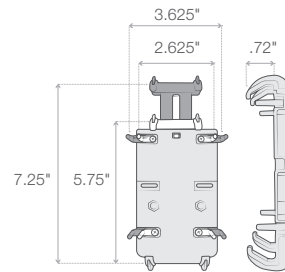

RAM® X-Grip®



RAM-HOL-UN7BU
Fits iPhone 13, 13 Pro & 13 mini

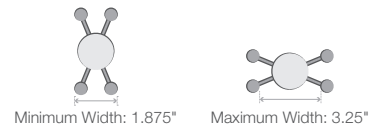

RAM-HOL-UN10BU
Fits iPhone 13 Pro Max

BEST SELLER

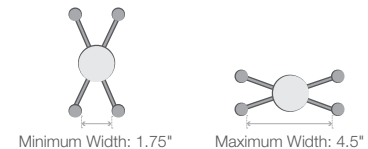

RAM® Ball Adapter for Apple MagSafe



RAM-B-202-AP-MAGU
Fits entire iPhone 13 Series



SEEN IN THIS PHOTO:

RAM-B-121-TAB2U

RAM® Tab-Tite™ Yoke Clamp Mount
for iPad mini Series + More

Features

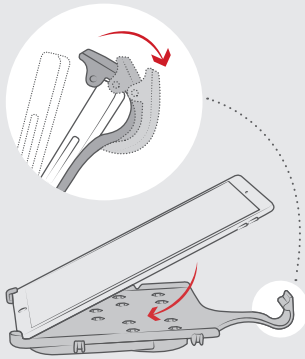

Patented roller design protects device and makes the insertion & removal of the tablet easy

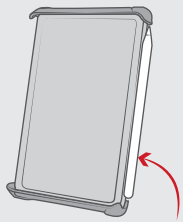

Connect and charge the Apple Pencil while in the Tab-Tite holder

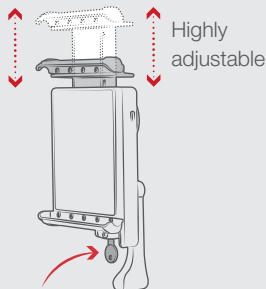

Non-locking and locking options available

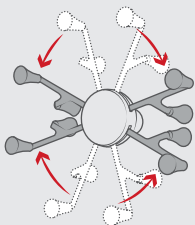

Highly adjustable to support tablets in portrait and landscape mode

iPad mini 6

The newest and most exciting iPad yet just got the support it needed. RAM® Mounts carries the necessary holders for the new iPad mini 6, including the form-fitting RAM® EZ-Roll'r™ cradle, the RAM® Tab-Tite™ holder, and the RAM® X-Grip® for cased iPad mini 6's.



RAM-HOL-AP36U
RAM® EZ-Roll'r™ Cradle

RAM® Tab-Tite™ & RAM® Tab-Lock™

With Heavy Duty Case



RAM-HOL-TAB12U
Non-Locking

RAM-HOL-TABL12U
Locking

With Light Duty Case or No Case



RAM-HOL-TAB2U
Non-Locking

RAM-HOL-TABL2U
Locking

RAM® X-Grip®



RAM-HOL-UN8BU
RAM® X-Grip® Universal Holder for 7"-8" Tablets with B Size 1" Ball



RAM-HOL-UN8BCU
RAM® X-Grip® Universal Holder for 7"-8" Tablets with C Size 1.5" Ball



SEEN IN THIS PHOTO:

RAM-BM-L1-SB1-TAB2U

RAM® Tab-Tite™ with Kneeboard
Mount for iPad mini Series + More

Features

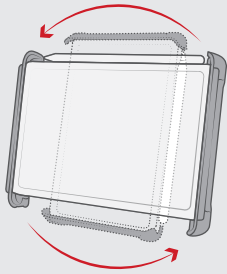

Easily position any aviation tablet mount between portrait or landscape mode

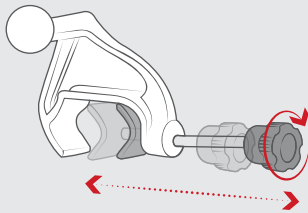

The yoke clamp base will fit rails in diameter from 0.625" to a maximum of 1.25"

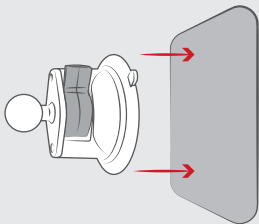

Holds strong against any windshield or non-porous surface

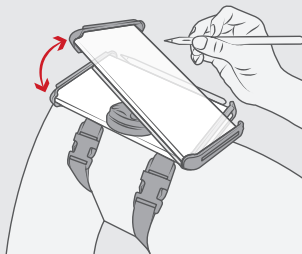

Kneeboard leg mount allows easy angling of tablet to avoid sun glare

iPad mini 6 Continued

EFB Solutions for Aviation

With RAM® Mounts in the cockpit, safely secure your iPad mini 6 model with or without a case. Engineered to withstand up to 50 g's of force, the RAM® double ball and socket system allows for near-infinite adjustability so your iPad can be placed exactly where it's needed. RAM® has partnered with airlines including Alaska, American, and Delta—as well as the U.S. Air Force—and continues to create inventive solutions that ensure important devices are secured in the sky.

Yoke Mounts



RAM-B-121-AP36U
RAM® EZ-Roll™ Cradle with Yoke Clamp Mount



RAM-B-121-TAB2U
RAM® Tab-Tite™ Yoke Clamp Mount



RAM-B-121-TAB12U
RAM® Tab-Tite™ Yoke Clamp Mount with Heavy Duty Cases

Suction Cup Mounts



RAM-B-166-AP36U
RAM® Twist-Lock™ Suction Cup



RAM-B-166-TAB12U
RAM® Twist-Lock™ Suction Cup with Heavy Duty Cases

Kneeboard Mounts



RAM-BM-L1-SB1-TAB2U
RAM® Tab-Tite™ with Kneeboard Mount



RAM-BM-L1-SB1-TAB12U
RAM® Tab-Tite™ with Kneeboard Mount

SEEN IN THIS PHOTO:

RAM-HOL-TAB17U

RAM® Tab-Tite™ Tablet Holder for Apple iPad 10.2 (9th Gen) with Case + More

RAM-VB-138-SW2

RAM® No-Drill™ Mount for '05-22 Toyota 4Runner & Tacoma



Features

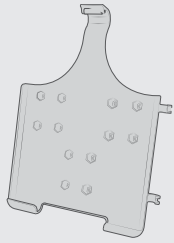

Form-fit cradle for the iPad 7th Gen and 8th Gen provides a perfect fit for your device without a case

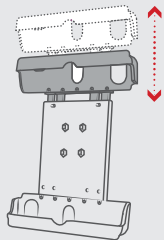

Highly Adjustable

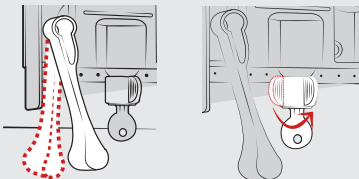

Locking mechanism for theft deterrence

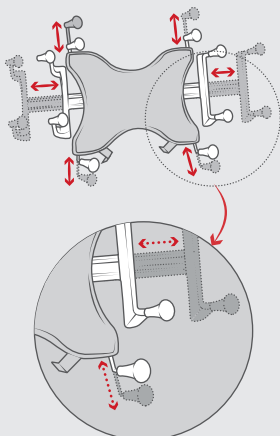

Additional grip handles for convenient insertion and removal

iPad 10.2 (9th Gen)

The 9th Generation iPad 10.2 is supported by almost all of RAM's tablet holders. Each holder provides a specific fit for the device as well as an IntelliSkin® option available for warehouse and/or fleet management. For a universal fit depending on whether your iPad 10.2 has a case, opt for the RAM® X-Grip® or the RAM® Tab-Tite™. For form-fitting holders, you'll want the dedicated form-fitting RAM® EZ-Roll'r™ cradle or for enterprise businesses, use IntelliSkin® paired with the GDS® Dock™ system.

Form-Fit



RAM-HOL-AP31U

RAM® EZ-Roll'r™ Cradle for Apple iPad 7th, 8th, & 9th Gen

RAM® Tab-Tite™ & RAM® Tab-Lock™



BEST SELLER



RAM-HOL-TAB20U
With case, Non-Locking

RAM-HOL-TABL20U
With case, Locking

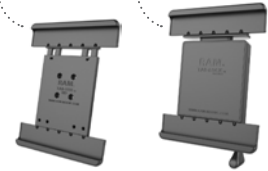

RAM-HOL-TAB26U
Without case, Non-Locking

RAM-HOL-TABL26U
Without case, Locking

RAM® X-Grip®



BEST SELLER

RAM-HOL-UN9U

RAM® X-Grip® Universal Holder for 9"-10" Tablets

SEEN IN THIS PHOTO:

RAP-460-UN7U

RAM® X-Grip® Phone Mount with
RAM® Tough-Strap™ Handlebar Base

DID YOU **KNOW**

RAM® Mounts focuses on universal solutions. Between the standard and large sizes, the RAM® X-Grip® for phones can hold any phone with or without a case.



Features

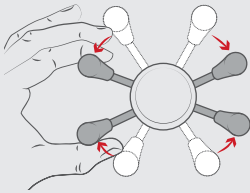

RAM® X-Grip® phone holder features an 'X' design that expands and contracts to provide a perfect fit for your device – even if it's in a case

RAM-HOL-UN7BU



Minimum Width: 1.875"

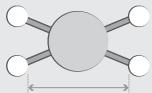

Maximum Width: 3.25"

RAM-HOL-UN10BU

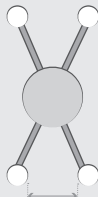

Minimum Width: 1.75"

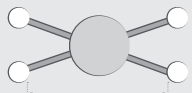

Maximum Width: 4.5"

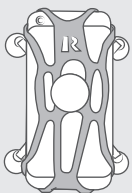

Includes safety tether for extra peace of mind

iPhone Holders

RAM® X-Grip®

The RAM® X-Grip® is the most durable universal phone holder on the market. The spring-loaded arms expand and contract to provide a perfect fit for your iPhone with or without a case. Available for iPhones of all sizes, the RAM® X-Grip® cradle secures your device while keeping it completely functional and accessible. No matter what mounting base you pair the RAM® X-Grip® with, the RAM® ball and socket technology allows for near-infinite adjustability and extends the life of your iPhone with vibration damping capabilities.

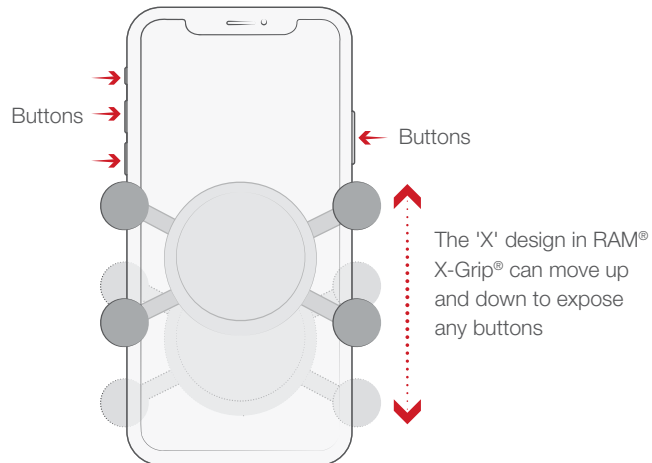

RAM-HOL-UN7BU

RAM® X-Grip® Universal Phone Holder with Ball



**BEST
SELLER**

RAM-HOL-UN10BU

RAM® X-Grip® Large Phone Holder with Ball

SEEN IN THIS PHOTO:

RAM-HOL-UN10-400U

RAM® X-Grip® Large Phone Mount with
RAM® Snap-Link™ Tough-Claw™



Features

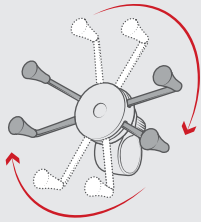

RAP-460-UN7 &
RAP-460-UN10U
RAM® Tough-Strap™ and RAM®
X-Grip®, easily rotate with the
turn of a single knob

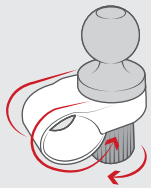

RAP-460-UN7 &
RAP-460-UN10U
Quick Release -
No Tools Required

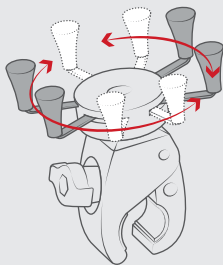

RAM-HOL-UN7-400-2U &
RAM-HOL-UN10-400-2U
Easily positions the RAM®
X-Grip® between portrait and
landscape mode

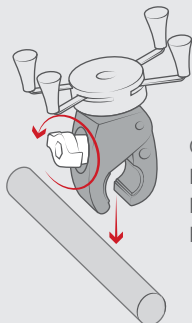

Quick
Release -
No Tools
Required

iPhone Holders Continued

RAM® X-Grip® Low Profile Mounts

Modified versions of the RAM® X-Grip® make it possible to create low-profile phone mounts designed for handlebars and other rails. Utilizing the patented RAM® Pin-Lock™ and RAM® Snap-Link™ technologies, the RAM® X-Grip® is able to sit as low as it can while attached to a RAM® Tough-Claw™, or the new RAM® Tough-Strap™. Each low-profile mount is available for standard-size iPhones and larger iPhones like the Pro Max models.

UN7



Minimum Width: 1.875"



Maximum Width: 3.25"

UN10



Minimum Width: 1.75"

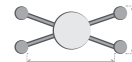

Maximum Width: 4.5"



RAP-460-UN7U
RAM® X-Grip® Phone
Mount with RAM®
Tough-Strap™
Handlebar Base



RAP-460-UN10U
RAM® X-Grip® Large
Phone Mount with
RAM® Tough-Strap™
Handlebar Base



RAP-460Z-UN7U
RAM® X-Grip® Phone
Mount with Low
Profile Zip Tie
Handlebar Base



RAP-460Z-UN10U
RAM® X-Grip® Large
Phone Mount with
Low Profile Zip Tie
Handlebar Base

**BEST
SELLER**



RAM-HOL-UN7-400-2U
RAM® X-Grip® Phone
Mount with Low-Profile
RAM® Tough-Claw™



RAM-HOL-UN10-400-2U
RAM® X-Grip® Large
Phone Mount with
Low-Profile RAM®
Tough-Claw™



RAM-HOL-UN7-400U
RAM® X-Grip® Phone
Mount with
RAM® Snap-Link™
Tough-Claw™



RAM-HOL-UN10-400U
RAM® X-Grip® Large
Phone Mount with
RAM® Snap-Link™
Tough-Claw™

SEEN IN THIS PHOTO:

RAM-B-149Z-A-PD4U

RAM® Quick-Grip™ XL Phone Mount
with Handlebar U-Bolt Base



Features

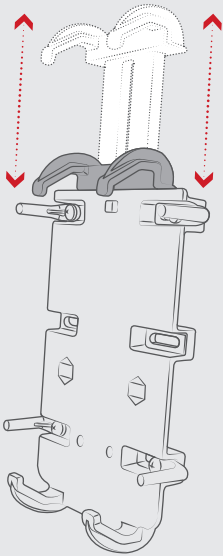

Highly adjustable

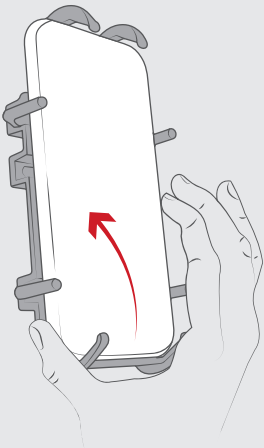

One-handed docking and removal

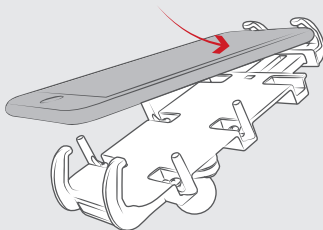

Spring-loaded top grip keeps device in place

iPhone Holders Continued

RAM® Quick-Grip™

Capable of holding a broad range of electronics, the spring-loaded grips provide a secure fit for your iPhone with or without a case. Take advantage of efficient one-handed placement and removal of your device no matter if the iPhone is in portrait, or landscape. The adjustable side support arms add extra security and can shift to fit the width of your device perfectly. Available for standard size iPhones and XL models.

Adjustable side fingers for wider devices, they can move to expose any buttons

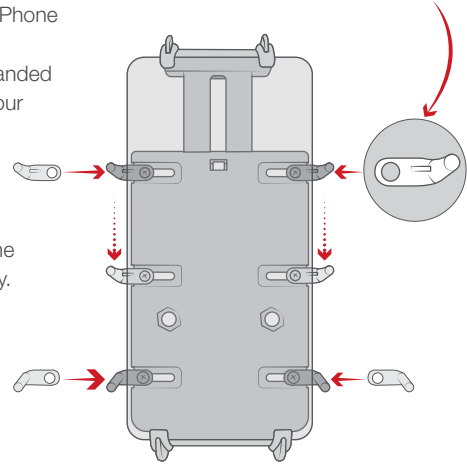

RAM-HOL-PD3-238AU
Small Phone Holder

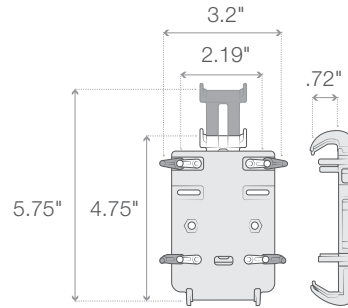

RAM-HOL-PD3-238AU
Small Phone Holder

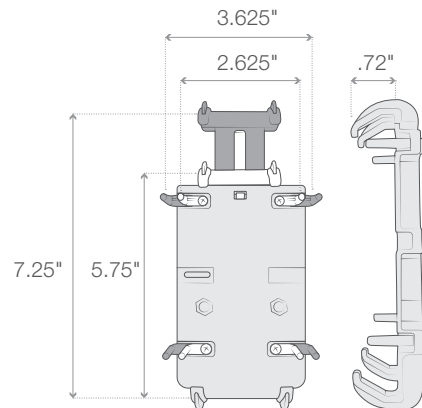

**BEST
SELLER**



SEEN IN THIS PHOTO:

RAM-B-166-UN15WU

RAM® Quick-Grip™ Suction Cup Mount
for Apple MagSafe Compatible Phones

Features

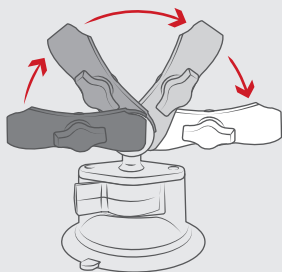
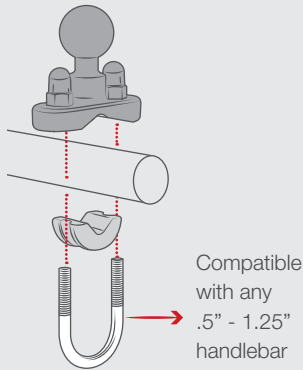
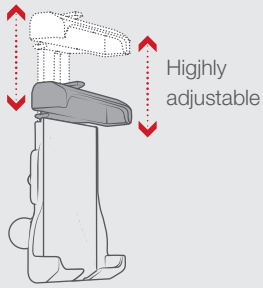

Double ball and socket technology allows for near-infinite adjustability of your RAM® mounting system

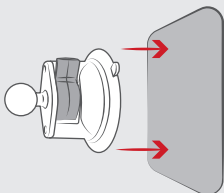

Holds strong against any windshield or non-porous surface

iPhone Holders Continued

RAM® Quick-Grip™ for Apple MagSafe Compatible Phones

For iPhone 12 models, take advantage of the Apple MagSafe charger by installing in the modified RAM® Quick-Grip™ for extra-rugged applications. The RAM® Quick-Grip™ has the added benefit of holding your phone in place with top and bottom cups so you don't solely rely on the magnetic feature of the Apple MagSafe—simply adjust the position of the charging puck to the back of your iPhone 12 to set its position for perfect alignment, every time. The Apple MagSafe's magnetic features keep your phone mounted in place while simultaneously charging the iPhone 12, 12 Pro, 12 mini & 12 Pro Max models.

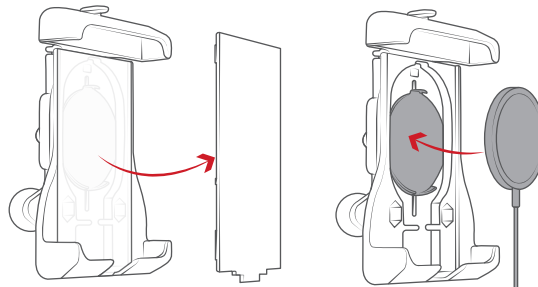

Removable backing plate to adjust the position of the Apple MagSafe charger

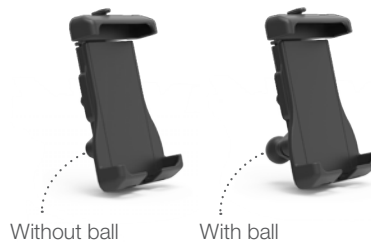

RAM-HOL-UN15WU
RAM® Quick-Grip™ Holder without Ball

RAM-HOL-UN15WBU
RAM® Quick-Grip™ Holder with Ball



RAM-B-149Z-A-UN15WU
RAM® Quick-Grip™ Handlebar Mount



RAM-B-166-UN15WU
RAM® Quick-Grip™ Suction Cup Mount



SEEN IN THIS PHOTO:

RAM-B-166-AP-MAGU

RAM® Twist-Lock™ Suction Cup Mount for Apple MagSafe

Features

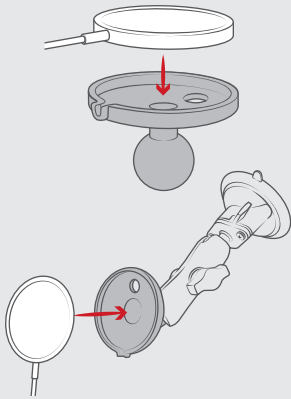

This adapter allows a perfect and secure fit for the Apple MagSafe's charging disk

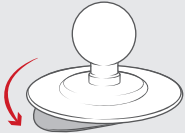

Flexible base conforms to flat or curved dash surfaces



Insert and twist the Stubby™ into your cup holder to create proper friction. Fits any cup holder from 2.57" - 3.5" in diameter

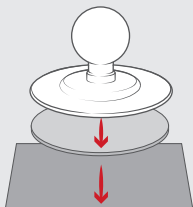

Powerful 3M adhesive for any hard, smooth or textured surfaces

iPhone Holders Continued

Apple MagSafe Adapter

For iPhone 12 & 13 models, take advantage of the Apple MagSafe charger by inserting in the magnetic disk into the RAM® Ball Adapter for Apple MagSafe Charger for on-road, closed cockpit vehicles. Take your Apple MagSafe charger in-vehicle by popping it into the RAM® Ball Adapter and pairing with any B size mounting components. The Apple MagSafe's magnetic features keep your phone mounted in place while simultaneously charging the iPhone 12, 12 Pro, 12 mini, 12 Pro Max, or 13 models.



RAP-B-202-AP-MAGU

RAM® Ball Adapter

*Recommended only for light duty and/or closed cockpit environments



RAM-B-166-AP-MAGU

RAM® Twist-Lock™ Suction Cup Mount



RAP-B-378-AP-MAGU

RAM® Flex Adhesive Double Ball Mount



RAM-B-102-AP-MAGU

RAM® Drill-Down Mount



RAP-B-299-4-AP-MAGU

RAM® Stubby™ Cup Holder Mount



RAP-SB-180-AP-MAGU

RAM® Lil Buddy™ Adhesive Dash Mount

SEEN IN THIS PHOTO:

RAM-HOL-AP24U

RAM® EZ-Roll'r™ Cradle for the
Apple iPad Pro 12.9" 3rd Gen

RAM-VB-203-SW2

RAM® No-Drill™ Mount for '19-22
Chevy Silverado + More



SEEN IN THIS PHOTO:

RAM-HOL-AP20U

RAM® EZ-Roll'r™ Cradle for
Apple iPad mini 4 & 5

RAP-404-202U

RAM® Tough-Claw™ Medium
Clamp Double Ball Mount
with Round Plate



Features

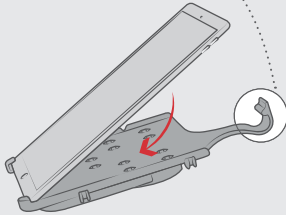
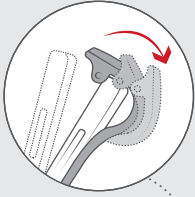

Patented roller design protects device and makes the insertion & removal of the tablet easy

Multiple hole patterns allow your iPad to be centered in portrait or landscape mode

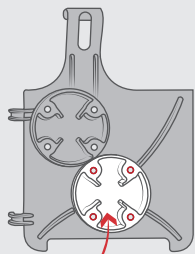
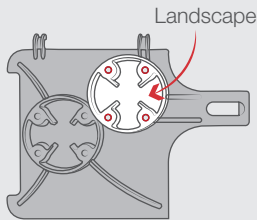

Portrait

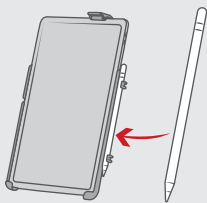

Integrated Apple Pencil holder for select models

iPad Holders

RAM® EZ-Roll'r™

These form-fit holders are designed to fit your device perfectly for a low-profile mounting solution. The patented roller design allows for easy docking and removal of the tablet without fumbling around. Modified versions of these holders include combo and key-locking features for theft deterrence as well as a holder for the Apple Pencil.



RAM-HOL-AP36U

RAM® EZ-Roll'r™ Cradle for iPad mini 6



RAM-HOL-AP23U

RAM® EZ-Roll'r™ Cradle for Apple iPad Pro 11" (1st - 3rd Gen) & Air 4



RAM-HOL-AP23CLU

RAM® EZ-Roll'r™ Combo Locking Holder for iPad Pro 11" & Air 4



RAM-HOL-AP24U

RAM® EZ-Roll'r™ Cradle for the Apple iPad Pro 12.9" 3rd Gen



RAM-HOL-AP24KLU

RAM® EZ-Roll'r™ Keyed Locking Holder for iPad Pro 12.9 3rd - 5th Gen



RAM-HOL-AP20U

RAM® EZ-Roll'r™ Cradle for Apple iPad mini 4 & 5



RAM-HOL-AP31KLU

RAM® EZ-Roll'r™ Keyed Locking Holder for iPad 7th-9th Gen & Air 3

SEEN IN THIS PHOTO:

RAM-HOL-UN9U

RAM® X-Grip® Universal Holder for 9"-10" Tablets

RAM-101U-247-4

RAM® 4" Square Post Clamp Mount with Round AMPS Plate

DID YOU **KNOW**

Between the three size offerings, the RAM® X-Grip® will support virtually any size tablet with or without a case or sleeve



Features

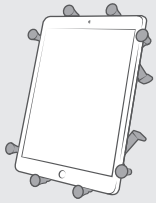

Steel spring-loaded arms keep tablets secure

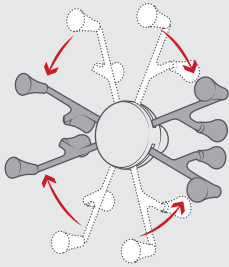

Highly adjustable to support tablets in portrait and landscape mode

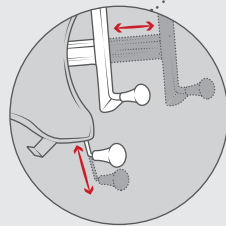
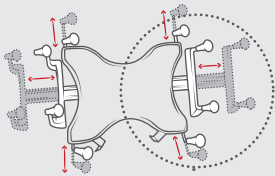

Additional grip handles for convenient insertion and removal

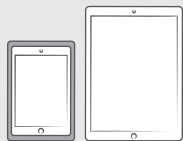

Fits all tablets 7" - 12" with or without a case

iPad Holders Continued

RAM® X-Grip® for iPads

The RAM® X-Grip® for tablets is the most durable universal holder on the market. The spring-loaded arms expand and contract to provide a perfect fit for your iPad with or without a case. Available for iPads of all sizes, the RAM® X-Grip® holder secures your device from all angles while keeping it completely functional and accessible. No matter what mounting base you pair the RAM® X-Grip® with, the RAM® ball and socket technology allows for near-infinite adjustability and extends the life of your iPad with vibration damping capabilities.



RAM-HOL-UN8BCU

RAM® X-Grip® Universal Holder for 7"-8" Tablets with Ball



**BEST
SELLER**

RAM-HOL-UN9U

RAM® X-Grip® Universal Holder for 9"-10" Tablets



RAM-HOL-UN11U

For 11"-12" Tablets

SEEN IN THIS PHOTO:

RAM-HOL-TAB20U

RAM® Tab-Tite™ Holder for 9"-10.5"
Tablets with Heavy Duty Cases



Features

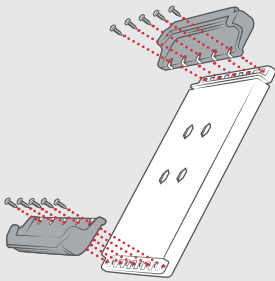

Interchangeable cups support any tablet

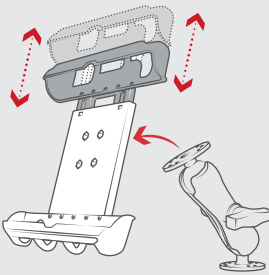

Adjustable to secure all tablets

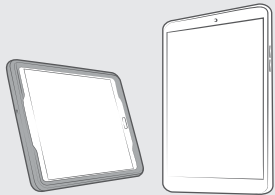

Supports tablets in portrait and landscape mode

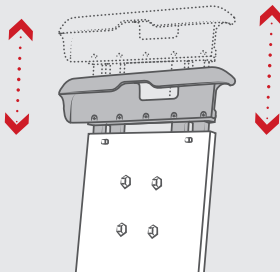

Locking mechanism for theft deterrence

iPad Holders Continued

RAM® Tab-Tite™ & Tab-Lock™

The RAM® Tab-Tite™ spring-loaded, quick release holder offers a secure fit with easy access to the mounted iPad. The spring-loaded design makes it easy to insert and remove your tablet, while keeping it secure in a variety of applications. The custom end cups are designed to optimize the functionality of your iPad, enabling access to all buttons, ports, and iPad functions. For harsh environments and theft deterrence, our RAM® Tab-Lock™ includes a keyed locking system. The RAM® Tab-Tite™ holder offers configurations compatible with any iPad.



With Case

Non-Locking

BEST SELLER

RAM-HOL-TAB20U

With Case, Non-Locking for 9"-10.5" Tablets with Heavy Duty Cases



With Case

Locking

RAM-HOL-TABL20U

With Case, Locking for 9"-10.5" Tablets with Heavy Duty Cases



With Case

Non-Locking

RAM-HOL-TAB17U

With Case, Non-Locking for Apple iPad Gen 1-4



Without Case

Locking

RAM-HOL-TABL17U

Without Case, Locking for Apple iPad Gen 1-4



With Case

Non-Locking

RAM-HOL-TAB12U

With Case, Non-Locking for 8" Tablets



Without Case

Locking

RAM-HOL-TABL12U

Without Case, Locking for 8" Tablets

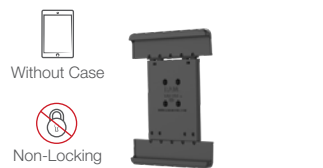

Without Case

Non-Locking

RAM-HOL-TAB26U

Without Case, Non-Locking for 9"-10.5" Tablets



Without Case

Locking

RAM-HOL-TABL26U

Without Case, Locking for 9"-10.5" Tablets



SEEN IN THIS PHOTO:

RAM-401-202U
RAM® Tough-Claw™ Large Clamp
Double Ball Mount with Round Plate

RAM-HOL-AP20U
RAM® EZ-Roll'r™ Cradle for Apple
iPad mini 4 & 5

Features

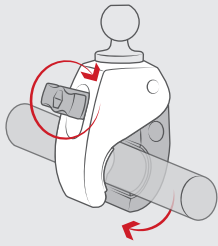

Toolless installation for convenient transfer and removal of base

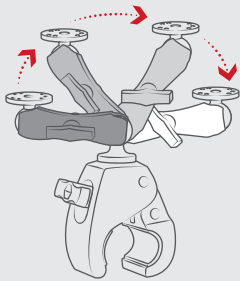

Double ball and socket technology allows for near-infinite adjustability of your RAM® mounting system

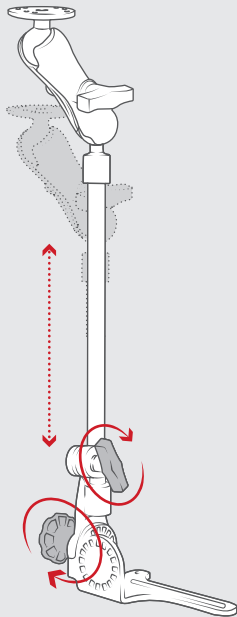

Highly adjustable

RAM® iPad Mounts Double Ball Mounts

RAM® double ball mounts and socket arms allow for near-infinite adjustability while also providing shock and vibration damping in several different applications. We've done all the work in determining which turnkey kits are available for a seamless shopping experience. Just tell us your device and vehicle and we'll have a solution ready for you.

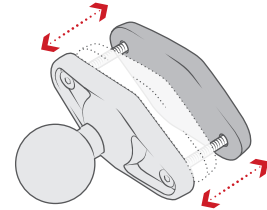

Highly adjustable

RAM-101U-247-3

RAM® 3" Square Post Clamp Mount with Round AMPS Plate



RAP-401-202U

RAM® Tough-Claw™ Large Clamp Double Ball Mount with Round Plate



RAM-101U-B-XAT1

RAM® Universal Backing Plate Mount



RAM-316-HD-18-202U

RAM® Pod HD™ Vehicle Mount with 18" Aluminum Rod and Round Plate



SEEN IN THIS PHOTO:

RAM-VB-195-SW2

RAM® No-Drill™ Mount for '15-22 Ford F-150, '17-22 F-250 + More

RAM-HOL-UN9U

RAM® X-Grip® Universal Holder for 9"-10" Tablets

RAM-B-400-HOL-UN7BU

RAM® X-Grip® Phone Mount with RAM® Tough-Claw™ Small Clamp Base

Features

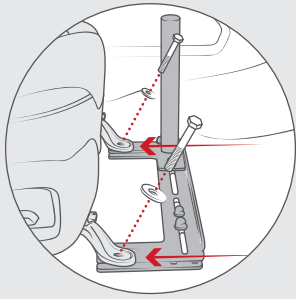

Mounts to vehicle's existing seat bolts

Ball and socket technology allows for near-infinite adjustability of your RAM® mounting system

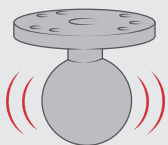
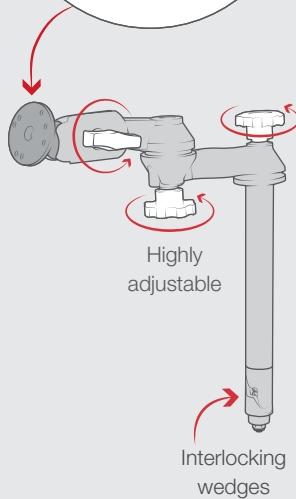
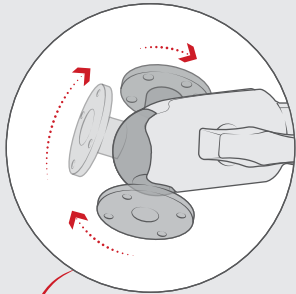

Absorbs shock and vibration

RAM® iPad Mounts Continued

RAM® No-Drill™

Available for a wide variety of vehicle makes, models, and years, RAM® No-Drill™ mounts are constructed from high quality steel. Each base attaches using existing seat bolts on the passenger side and is designed to fit your specific vehicle. Create the ultimate mobile workstation with the RAM® No-Drill™ as your platform.

**BEST
SELLER**

RAM-VB-195-SW2

RAM® No-Drill™ Mount for '15-22 Ford F-150, '17-22 F-250 + More



RAM-VB-193-SW2

RAM® No-Drill™ Mount for '14-19 Chevrolet Silverado + More



RAM-VB-196-SW2

RAM® No-Drill™ Universal Vehicle Floor Mount



RAM-VB-186ST1-SW2

RAM® No-Drill™ Mount for '19-22 Ram 1500 Pickup Trucks (5th Gen)

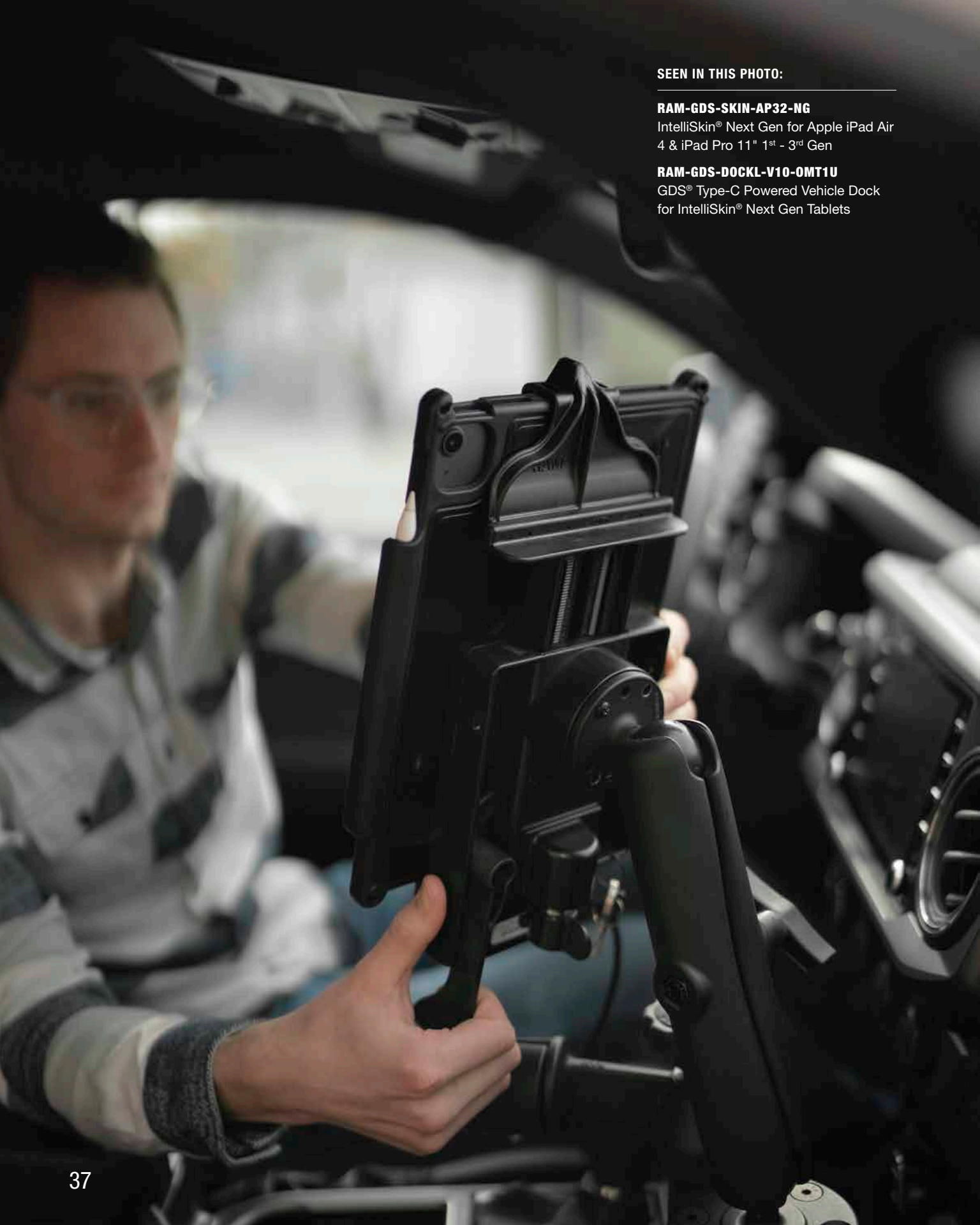

SEEN IN THIS PHOTO:

RAM-GDS-SKIN-AP32-NG

IntelliSkin® Next Gen for Apple iPad Air 4 & iPad Pro 11" 1st - 3rd Gen

RAM-GDS-DOCKL-V10-OMT1U

GDS® Type-C Powered Vehicle Dock for IntelliSkin® Next Gen Tablets

Features

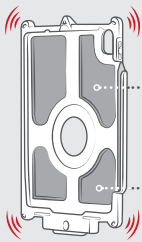

Hard plastic shell with shock absorbing rubber

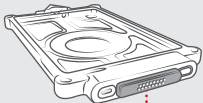

Pogo pin technology protects your device ports from constant plugging and unplugging.



Positioning marker provides universal compatibility across IntelliSkin® Next Gen protective sleeves and GDS® top cups

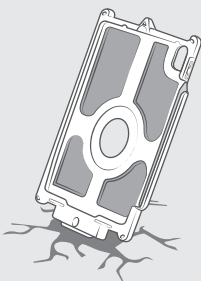

Drop protection, having passed rigorous military-grade spec tests for withstanding shock and impact.

IntelliSkin® & IntelliSkin® Next Gen

IntelliSkin® is a protective sleeve for phones and tablets featuring GDS® Tech™ with pogo pin technology and military-grade drop protection. With an integrated GDS® connector molded directly into each skin and ruggedized docking contacts on each skin's exterior, IntelliSkin® is designed to extend the life of devices by preventing damage to the charging port from repetitive docking. IntelliSkin® Next Gen sleeves feature flat docking contacts that are easier to clean, as well as a design that combines a hard plastic shell with soft, shock-absorbing rubber.



RAM-GDS-SKIN-AP36-NG
IntelliSkin® Next Gen for Apple iPad mini 6



See page 40 for more GDS® vehicle docks



RAM-GDS-SKIN-AP24-A
IntelliSkin® for the Apple iPad Pro 12.9" (3rd - 5th Gen)



RAM-GDS-SKIN-AP23-A
IntelliSkin® for the Apple iPad Pro 11" (2nd & 3rd Gen)

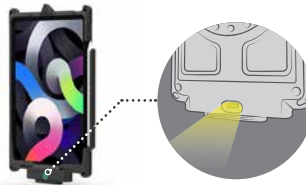

RAM-GDS-SKIN-AP32-NG-LED
IntelliSkin® Next Gen with LED for iPad Air 4 & Pro 11" 1st - 3rd Gen



RAM-GDS-SKIN-AP32-NG
IntelliSkin® Next Gen for iPad Air 4 & Pro 11" 1st - 3rd Gen



RAM-GDS-SKIN-AP37-NG
IntelliSkin® Next Gen for Apple iPad Pro 12.9 3rd - 5th Gen



RAM-GDS-SKIN-AP27
IntelliSkin® for Apple iPad mini 4 & 5

SEEN IN THIS PHOTO:

RAM-GDS-SKIN-AP32-NG

IntelliSkin® Next Gen for Apple iPad Air 4 & iPad Pro 11" 1st - 3rd Gen

RAM-GDS-DOCKL-AP32CDU

Locking GDS® Tough-Dock™ + Single USB for iPad Air 4 & iPad Pro 11"

RAM-KB2-USB

GDS® Keyboard™ with Track Pad

RAM-VP-SW2F-89

RAM® Tele-Pole™ with 8" & 9" Poles and Double Ball Mount



GDS® Vehicle Docks

GDS® vehicle docks with GDS® Technology™ offer a universal charging platform for any device wrapped in an IntelliSkin® sleeve. IntelliSkin® offers drop protection and uses ruggedized external contacts to allow for repetitive docking, with no need to deal with charging cables.

iPad Air 4 & iPad Pro 11" 1st - 3rd Gen



RAM-GDS-DOCKL-AP32CD2U
Locking GDS® Tough-Dock™ + Dual USB

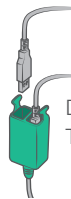

Dual USB
Type A Ports

iPad mini 4 and 5



RAM-GDS-DOCKL-V2-AP27U
Locking GDS® Vehicle Dock

iPad 12.9" 3rd - 5th Gen



RAM-GDS-DOCK-AP37CD2U
GDS® Tough-Dock™ + Dual USB for iPad Pro 12.9 3rd - 5th Gen

iPad mini 6



RAM-GDS-DOCKL-V10-OMT3U
Power Only, USB Type-C

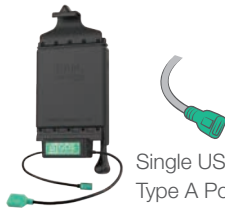

RAM-GDS-DOCKL-V10-OMT3CDU
Power + Single Peripheral

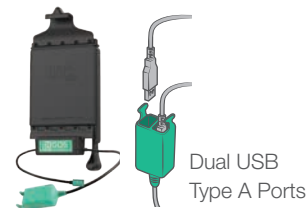

RAM-GDS-DOCKL-V10-OMT3CD2U
Power + Dual Peripheral

PART NUMBER	POWER USB TYPE-C	DATA SYNC	KEY- LOCKING	SINGLE USB TYPE A PORT PERIPHERAL SUPPORT	DUAL USB TYPE A PORTS PERIPHERAL SUPPORT
RAM-GDS-DOCK-AP32CPU	•				
RAM-GDS-DOCKF-AP32CPU	•				
RAM-GDS-DOCKL-AP32CPU	•		•		
RAM-GDS-DOCKLF-AP32CPU	•		•		
RAM-GDS-DOCK-AP32CDU	•			•	
RAM-GDS-DOCKL-AP32CD2U	•		•		•
RAM-GDS-DOCKL-AP32CDU	•		•	•	
RAM-GDS-DOCK-AP32CD2U	•				•
RAM-GDS-DOCK-AP32CU	•	•			
RAM-GDS-DOCKF-AP32CU	•	•			
RAM-GDS-DOCKL-AP32CU	•	•	•		
RAM-GDS-DOCKLF-AP32CU	•	•	•		



SEEN IN THIS PHOTO:

RAM-GDS-SKIN-AP16

IntelliSkin® for the Apple iPad Pro 10.5 & iPad Air 3

RAM-GDS-DOCK-D2U

GDS® Desktop Dock with mUSB 2.0

Features

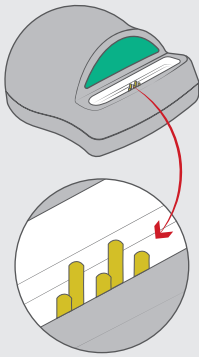

The Desktop Dock features pogo pin contacts designed to match the pogo pads on IntelliSkin®-wrapped devices

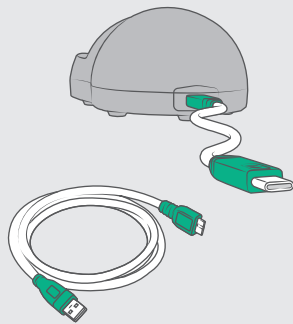

Power and data transfer via male to male mUSB to USB Type A cord; plugs directly into mUSB port on the back of the dock

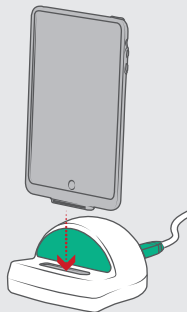

Low-profile docking station for phones and tablets equipped with an IntelliSkin® protective case

GDS® Desktop Docks For Devices with Lightning Connector iPad 7th - 9th Gen, iPad mini 4 & 5

Perfect for office environments, GDS® desktop docks can support any device equipped with an IntelliSkin® sleeve to deliver full-time charging as well as data transfer capabilities. Docks ranging from single to multi-device support keep phones and tablets protected and at the ready. GDS® desktop docks support a number of phones and tablets as well as power and data communication.

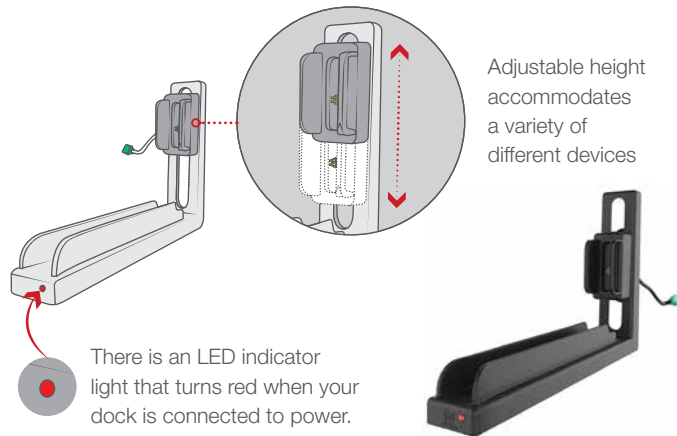

Adjustable height accommodates a variety of different devices

There is an LED indicator light that turns red when your dock is connected to power.

RAM-GDS-DOCK-G7M-NGU

GDS® Slide Dock™ with Magnetic Attachment for IntelliSkin®



RAM-GDS-DOCK-D2U

GDS® Desktop Dock with mUSB 2.0

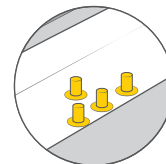

Utilizing GDS® pogo pin technology, this multiport-charging station charges any IntelliSkin®-wrapped device

Single cord power supply, with one plug in the back, power is supplied to all docked devices at the same time

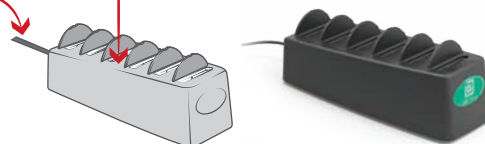

RAM-GDS-DOCK-6G1PU

GDS® 6-Port Desktop Charger for IntelliSkin® Products



SEEN IN THIS PHOTO:

RAM-GDS-SKIN-AP24-A

IntelliSkin® for the Apple iPad Pro 12.9" 3rd, 4th & 5th Gen

RAM-GDS-DOCK-D7AU

GDS® Desktop Dock with Power Delivery & Peripheral Port

Features

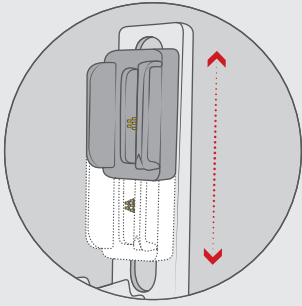

RAM-GDS-DOCK-G7M-8-NGU
Adjustable height accommodates a variety of different devices

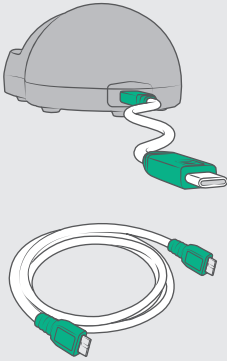

Power Delivery docks include a male to male USB Type-C cord which plugs directly into the back of the dock and to a Power Delivery charging source, or external hub

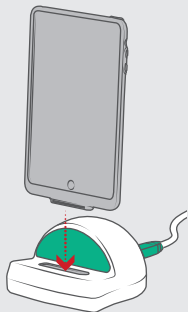

Low-profile docking station for phones and tablets equipped with an IntelliSkin® protective case

GDS® Desktop Docks Continued

For Devices with USB Type-C

iPad mini 6, iPad Air 4, iPad Pro 11" 1st - 3rd Gen, iPad Pro 12.9" 3rd - 5th Gen



RAM-GDS-DOCK-G7M-8-NGU
GDS® Slide Dock™ with Power Delivery & Magnets for IntelliSkin® Next Gen



RAM-GDS-DOCK-D7AU
GDS® Desktop Dock with Power Delivery & Peripheral Port

USB Type A port on the side of the dock for peripheral add-ons to turn the desktop dock into a workstation using a keyboard, mouse or other peripheral

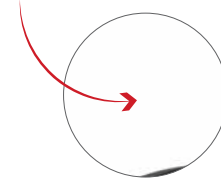

RAM-GDS-DOCK-D7U
GDS® Desktop Dock with Power Delivery

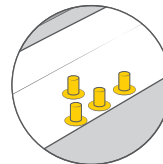

Utilizing GDS® pogo pin technology, this multiport-charging station charges any IntelliSkin® Next Gen wrapped device

Includes 180 watt AC/DC power supply and supports USB 2.0/3.0 phones and tablets

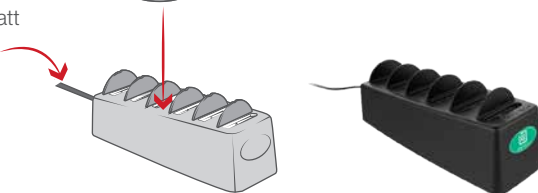

RAM-GDS-DOCK-G6G1PD-NGU
GDS® 6-Port Power Delivery Desktop Charger for IntelliSkin® Next Gen

SEEN IN THIS PHOTO:

RAM-GDS-HS1U

GDS® Hand-Stand™ Hand Strap and Kickstand for Tablets



Features

Provides charging and data sync capabilities to IntelliSkin®-wrapped devices

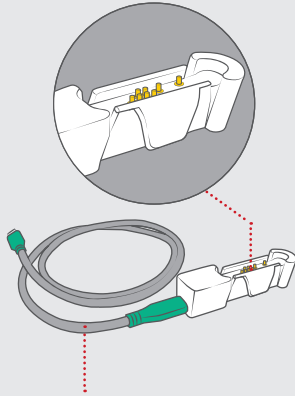

Power Delivery capable through an integrated 1M male to male USB Type-C cable

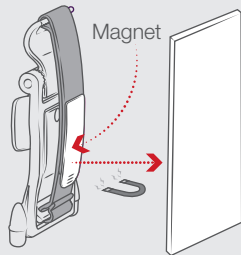

Magnetic GDS® Hand-Stand™ connects to any ferro-magnetic surface

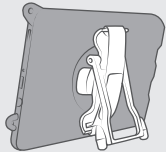

GDS® Hand-Stand™ compatible with most IntelliSkin® wrapped tablets



Enhances comfort and convenient for any phone or tablet on the go

GDS® Ergo™

Enable your iPad for field use with these GDS® Ergo™ accessories. The GDS® Hand-Stand™ is a combination hand strap and kickstand that allows you to take your device from the warehouse to the office—and everywhere in between. With the shoulder strap accessory, quickly attach various IntelliSkin® sleeves to comfortably carry your iPad.

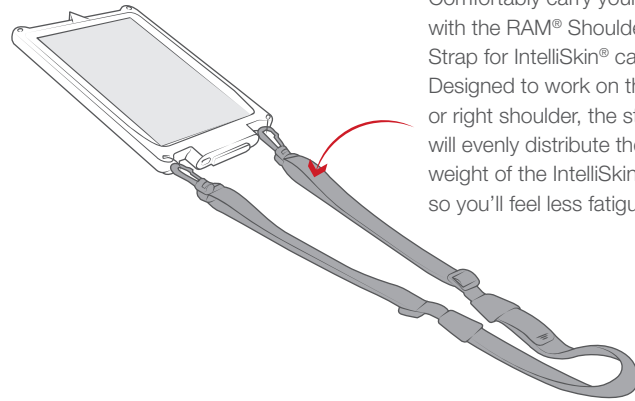

Comfortably carry your tablet with the RAM® Shoulder Strap for IntelliSkin® cases. Designed to work on the left or right shoulder, the strap will evenly distribute the weight of the IntelliSkin® case so you'll feel less fatigue



RAM-GDS-SS1U

GDS® Shoulder Strap Accessory for IntelliSkin® Products



RAM-GDS-AD3CMU

GDS® Snap-Con™ GDS® to Power Delivery USB Type-C Adapter



RAM-GDS-HS1U

GDS® Hand-Stand™ Hand Strap and Kickstand for Tablets



RAM-GDS-HS1MU

GDS® Hand-Stand™ Magnetic Hand Strap and Kickstand for Tablets



RAM-GDS-CAB-USBC-CMCFU

GDS® Genuine USB Type-C .8 Meter Extension Cable, Power Delivery



RAM-GDS-CAB-USBC-CMCM-20-10

GDS® Genuine USB Type-C 2.0 Male to Male 1M Cable, Power Delivery

SEEN IN THIS PHOTO:

RAM-HS2U

RAM® Universal Hand-Stand™ for 9"-13" Tablets



Features

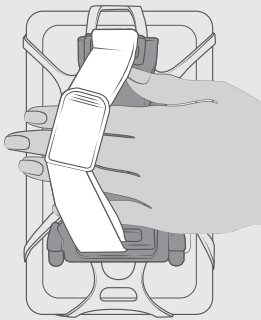

Enhances comfort and convenience for any tablet on the go

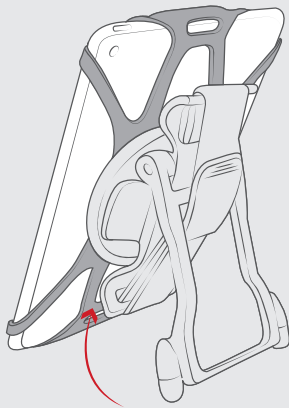

Durable rubber tether stretches around each corner of the tablet for a secure fit

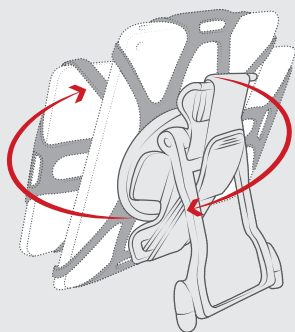

Rotates 360-degrees for landscape or portrait orientation

Accessories

RAM® Universal Hand-Stand™

The RAM® Universal Hand-Stand™ is a perfect ergonomic accessory for enabling your tablet for field use with or without a case. The RAM® Hand-Stand™ is specifically designed to attach to any tablet utilizing an included durable rubber tether that stretches over each corner of the tablet. The hand strap provides a comfortable fit for a gloved hand and can be rotated 360 degrees to find the ideal viewing angle. An integrated kickstand allows for positioning the tablet on a flat surface for on the go operation of your tablet.

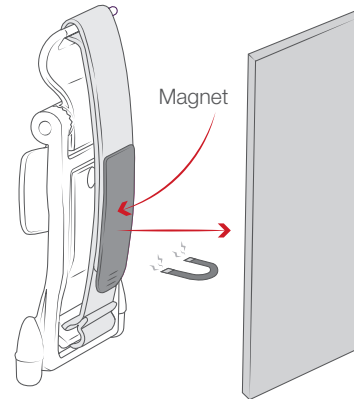

Magnetic strap connects to any ferro-magnetic surface



RAM-HS1MU
RAM® Universal Hand-Stand™ for 7"-8"
Tablets with Magnetic Strap



RAM-HS2MU
RAM® Universal Hand-Stand™ for 9"-
13" Tablets with Magnetic Strap



RAM-HS1U
RAM® Universal Hand-Stand™
for 7"-8" Tablets



RAM-HS2U
RAM® Universal Hand-Stand™ for
9"-13" Tablets

SEEN IN THIS PHOTO:

RAM-HS1-0T3BU

GDS® Hand-Stand™ with OtterBox
uniVERSE Tablet Case Adapter



Features

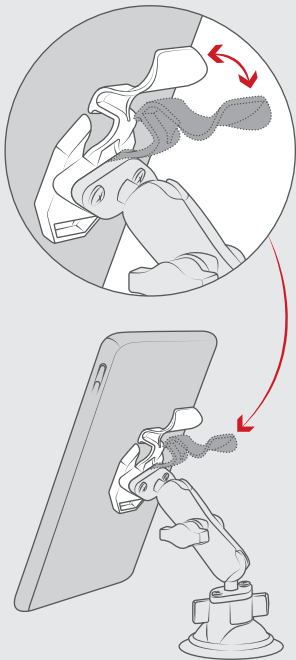

The RAM® Quick Release Vehicle Mount Adapter snaps onto the RAM-HOL-OT3BU. Once connected, you can attach any Apple tablet with Otterbox uniVERSE case

Double ball and socket technology allows for near-infinite adjustability of your RAM® mounting system

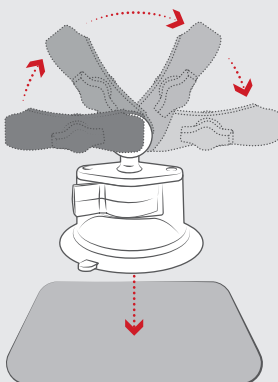

Holds strong against any windshield or non-porous surface

Built for **OTTERBOX**
uniVERSE

OtterBox uniVERSE Solutions for iPad

The RAM® Quick Release Adapter connects to the back of the OtterBox uniVERSE case with any iPad model. This octagon-shaped adapter can adapt to almost any RAM® double ball and socket mounting system. When not mounted, attach accessories like the GDS® Hand-Stand™—a two-in-one accessory that integrates a hand strap with a built-in kickstand.



RAM-HOL-OT3BU
RAM® Quick Release Holder



RAM-HS1-OT3BU
GDS® Hand-Stand™



RAM-HOL-OT3BU
RAM® Adapter



RAM-GDS-OT1U
GDS® OtterBox uniVERSE Module



RAM-B-166-OT3U
RAM® Twist-Lock™ Suction Cup Mount



RAM-316-HD-238-OT3U
RAM® Pod HD™ Vehicle Mount



SEEN IN THIS PHOTO:

RAM-B-166-0T2U
RAM® Twist-Lock™ Suction Cup Mount
for OtterBox uniVERSE Phone Cases

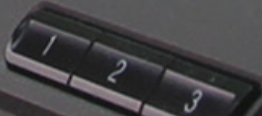

Features

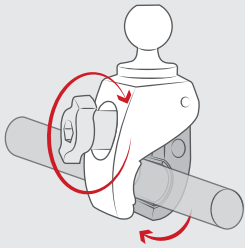

Toolless installation for convenient transfer and removal of base

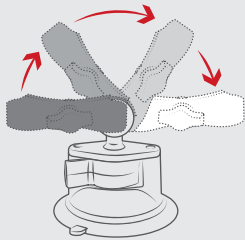

Double ball and socket technology allows for near-infinite adjustability of your RAM® mounting system

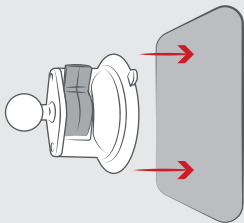

Holds strong against any windshield or non-porous surface

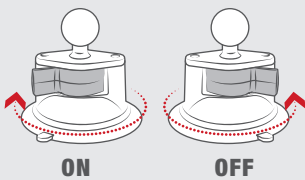

Patented RAM® Twist-Lock™ suction design

OtterBox uniVERSE Continued

Built for **OTTERBOX**
uniVERSE

Solutions for iPhone

The RAM® EZ-Roll'r™ phone holder secures your OtterBox uniVERSE-protected iPhone, allowing you to utilize the RAM® Twist-Lock™ Suction Cup or RAM® Tough-Claw™. For anyone who demands both protection and versatility, the combination of the OtterBox uniVERSE case and the RAM® double ball and socket system is the answer.



RAM-B-400-OT2U
RAM® Tough-Claw™ Small Clamp Mount



RAM-B-166-OT2U
RAM® Twist-Lock™ Suction Cup Mount



SEEN IN THIS PHOTO:

RAM-GDS-SKIN-AP32-NG

IntelliSkin® Next Gen for Apple iPad Air 4 & iPad Pro 11" 1st - 3rd Gen

RAM-GDS-DOCKL-AP32CD2U

Locking GDS® Tough-Dock™ + Dual USB for iPad Air 4 & iPad Pro 11"

RAM-D-101U-C-247-4

RAM® 4" Square Post Clamp Mount with Round AMPS Plate

RAM-DIS-103-1AU

RAM® Standard Accessory/Display Bracket

RAM-KB2-USB

GDS® Keyboard™ with Track Pad

RAM-101U

RAM® Double Ball Mount with Two Round Plates

Features

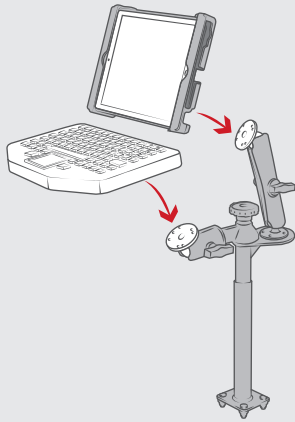

Articulating swing arm lower mount and flange pole base allows for full 360-degree rotation and additional RAM® socket arm for ideal placement of multiple devices such as a keyboard + tablet

Absorbs shock & vibration

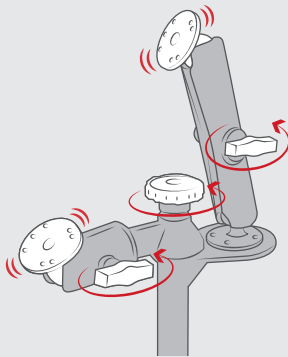

Highly adjustable

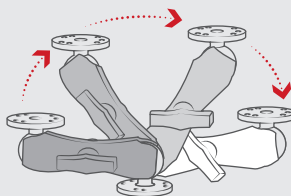

Double ball and socket technology allows for near-infinite adjustability of your RAM® mounting system

iPad + Keyboard Solutions

Replace your legacy laptops with new all-in-one Apple + RAM® Mounts with GDS® Keyboard™ mounting options. Integrate IntelliSkin® with GDS® Tech™ to create a full ecosystem, whether you are mounting in a vehicle with the RAM® Tele-Pole™ and Swing Arm System, or anywhere else using the display bracket option. Pair with any GDS® Keyboard™ and charging harness to connect your ecosystem inside any vehicle. The rugged pogo contacts in GDS® Technology™ offers a universal charging platform for any device wrapped in IntelliSkin®, eliminating the need to plug in a device every time you enter the vehicle, and making device refreshes a quick and inexpensive process.



RAM® Tele-Pole™ Systems for Vehicle



RAM-VP-SW2F-89

RAM® Tele-Pole™ with 8" & 9" Poles and Double Ball Mount

Display Bracket

RAM-DIS-103-1AU
RAM® Standard
Accessory/Display
Bracket



General Rule

RAM-202U
C Size 1.5" Ball
Mounts Can Support
any iPad or Keyboard



**RAM-D-202U +
RAM-DIS-103-1AU**
D Size 2.25" Ball Mounts Can Support
any iPad with Keyboard Using
Display Bracket

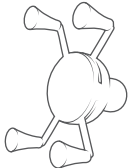
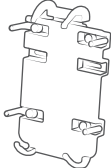
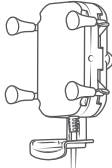
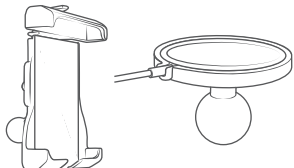

iPhone Holder Compatibility

Model	 RAM® Form-Fit	 RAM® X-Grip®	 RAM® Quick-Grip™	 RAM® Tough-Charge™	 RAM® Quick-Grip™ / ball adapter for Apple MagSafe
iPhone 6/6s	RAM-HOL-AP18U	RAM-HOL-UN7BU	RAM-HOL-PD3U	-	-
iPhone 6 Plus	RAM-HOL-AP19U	RAM-HOL-UN10BU	RAM-HOL-PD4U	-	-
iPhone 7	RAM-HOL-AP18U	RAM-HOL-UN7BU	RAM-HOL-PD3U	-	-
iPhone 7 Plus	RAM-HOL-AP19U	RAM-HOL-UN10BU	RAM-HOL-PD4U	-	-
iPhone 8	-	RAM-HOL-UN7BU	RAM-HOL-PD3U	RAM-HOL-UN12WB	-
iPhone 8 Plus	-	RAM-HOL-UN10BU	RAM-HOL-PD4U	RAM-HOL-UN12WB	-
iPhone SE	-	RAM-HOL-UN7BU	RAM-HOL-PD3U	RAM-HOL-UN12WB	-
iPhone X	RAM-HOL-AP25U	RAM-HOL-UN7BU	RAM-HOL-PD3U	RAM-HOL-UN12WB	-
iPhone Xr	RAM-HOL-AP26U	RAM-HOL-UN7BU	RAM-HOL-PD4U	RAM-HOL-UN12WB	-
iPhone Xs	RAM-HOL-AP25U	RAM-HOL-UN7BU	RAM-HOL-PD3U	RAM-HOL-UN12WB	-
iPhone Xs Max	RAM-HOL-AP19U	RAM-HOL-UN10BU	RAM-HOL-PD4U	RAM-HOL-UN12WB	-
iPhone 11	RAM-HOL-AP28U	RAM-HOL-UN7BU	RAM-HOL-PD4U	RAM-HOL-UN12WB	-
iPhone 11 Pro	RAM-HOL-AP29U	RAM-HOL-UN7BU	RAM-HOL-PD3U	RAM-HOL-UN12WB	-
iPhone 11 Pro Max	RAM-HOL-AP30U	RAM-HOL-UN10BU	RAM-HOL-PD4U	RAM-HOL-UN12WB	-
iPhone 12 & 12 Pro	RAM-HOL-AP33U	RAM-HOL-UN7BU	RAM-HOL-PD4U	RAM-HOL-UN12WB	RAM-HOL-UN15WBU RAP-B-202-AP-MAGU
iPhone 12 mini	RAM-HOL-AP34U	RAM-HOL-UN7BU	RAM-HOL-PD3U	RAM-HOL-UN12WB	RAM-HOL-UN15WBU RAP-B-202-AP-MAGU
iPhone 12 Pro Max	RAM-HOL-AP35U	RAM-HOL-UN10BU	RAM-HOL-PD4U	RAM-HOL-UN12WB	RAM-HOL-UN15WBU RAP-B-202-AP-MAGU
iPhone 13 & 13 Pro	-	RAM-HOL-UN7BU	RAM-HOL-PD4U	-	RAP-B-202-AP-MAGU
iPhone 13 mini	RAM-HOL-AP34U	RAM-HOL-UN7BU	RAM-HOL-PD3U	RAM-HOL-UN12WB	RAP-B-202-AP-MAGU
iPhone 13 Pro Max	RAM-HOL-AP35U	RAM-HOL-UN10BU	RAM-HOL-PD4U	RAM-HOL-UN12WB	RAP-B-202-AP-MAGU

iPad Holder Compatibility

Model	RAM® EZ-Roll™	RAM® X-Grip®	RAM® Tab-Tite™	RAM® Tab-Lock™	IntelliSkin®	GDS® Vehicle Dock
iPad 5 th - 6 th Gen	Non-Locking: RAM-HOL-AP17U Combo Locking: RAM-HOL-AP15CLU Key Locking: RAM-HOL-AP15KLU	RAM-HOL-UN9U	with case: RAM-HOL-TAB20U	with case: RAM-HOL-TABL20U	RAM-GDS-SKIN-AP15	RAM-GDS-DOCKL-V2-AP8U
iPad 7 th -9 th Gen	Non-Locking: RAM-HOL-AP31U Combo Locking: RAM-HOL-AP31CLU Key Locking: RAM-HOL-AP31KLU	RAM-HOL-UN9U	without case: RAM-HOL-TAB26U with case: RAM-HOL-TAB20U	without case: RAM-HOL-TABL26U with case: RAM-HOL-TABL20U	RAM-GDS-SKIN-AP31	RAM-GDS-DOCKL-V9-OMT1U
iPad Air	Non-Locking: RAM-HOL-AP17U Combo Locking: RAM-HOL-AP15CLU Key Locking: RAM-HOL-AP15KLU	RAM-HOL-UN9U	without case: RAM-HOL-TAB6U with case: RAM-HOL-TAB20U	without case: RAM-HOL-TABL6U with case: RAM-HOL-TAB20LU	-	-
iPad Air 2	Non-Locking: RAM-HOL-AP17U Combo Locking: RAM-HOL-AP15CLU Key Locking: RAM-HOL-AP15KLU	RAM-HOL-UN9U	without case: RAM-HOL-TAB6U with case: RAM-HOL-TAB20U	without case: RAM-HOL-TABL6U with case: RAM-HOL-TABL20U	RAM-GDS-SKIN-AP8	RAM-GDS-DOCKL-V2-AP8U
iPad Air 3	Non-Locking: RAM-HOL-AP22U Combo Locking: RAM-HOL-AP31CLU Key Locking: RAM-HOL-AP31KLU	RAM-HOL-UN9U	without case: RAM-HOL-TAB26U with case: RAM-HOL-TAB20U	without case: RAM-HOL-TABL26U with case: RAM-HOL-TABL20U	RAM-GDS-SKIN-AP16	RAM-GDS-DOCKL-V2-AP16U
iPad mini 2 & mini 3	RAM-HOL-AP14U	RAM-HOL-UN8BCU	without case: RAM-HOL-TAB27U with case: RAM-HOL-TAB29U	without case: RAM-HOL-TABL27U with case: RAM-HOL-TABL29U	RAM-GDS-SKIN-AP2	RAM-GDS-DOCKL-V2-AP2U
iPad mini 4	RAM-HOL-AP20U	RAM-HOL-UN8BCU	without case: RAM-HOL-TAB30U with case: RAM-HOL-TAB12U	without case: RAM-HOL-TABL30U with case: RAM-HOL-TABL12U	RAM-GDS-SKIN-AP7	RAM-GDS-DOCKL-V2-AP7U
iPad mini 5	RAM-HOL-AP20U	RAM-HOL-UN8BCU	without case: RAM-HOL-TAB30U with case: RAM-HOL-TAB12U	without case: RAM-HOL-TABL30U with case: RAM-HOL-TABL12U	RAM-GDS-SKIN-AP27	RAM-GDS-DOCKL-V2-AP27U
iPad mini 6	Non-Locking: RAM-HOL-AP36U	RAM-HOL-UN8BCU	without case: RAM-HOL-TAB2U with case: RAM-HOL-TAB12U	without case: RAM-HOL-TABL2U with case: RAM-HOL-TABL12U	RAM-GDS-SKIN-AP36-NG	RAM-GDS-DOCKL-V10-OMT3CD2U RAM-GDS-DOCKL-V10-OMT3CD2U
iPad Pro 10.5	Non-Locking: RAM-HOL-AP22U Combo Locking: RAM-HOL-AP31CLU Key Locking: RAM-HOL-AP31KLU	RAM-HOL-UN9U	without case: RAM-HOL-TAB26U with case: RAM-HOL-TAB20U	without case: RAM-HOL-TABL26U with case: RAM-HOL-TABL20U	RAM-GDS-SKIN-AP16	RAM-GDS-DOCKL-V2-AP16U
iPad Pro 11* (1 st -3 rd Gen)	Non-Locking: RAM-HOL-AP23U Combo Locking: RAM-HOL-AP23CLU Key Locking: RAM-HOL-AP23KLU	RAM-HOL-UN9U	without case: RAM-HOL-TAB3U with case: RAM-HOL-TAB17U	without case: RAM-HOL-TABL3U with case: RAM-HOL-TABL17U	RAM-GDS-SKIN-AP32-NG	RAM-GDS-DOCKL-V2-AP23U For Vehicle Dock see page 39 & 40
iPad Pro 12.9 (1 st - 2 nd Gen)	RAM-HOL-AP21U	RAM-HOL-UN11U	-	-	-	-
iPad Pro 12.9 (3 rd - 4 th Gen)	Non-Locking: RAM-HOL-AP24U Combo Locking: RAM-HOL-AP24CLU Key Locking: RAM-HOL-AP24KLU	RAM-HOL-UN11U	-	-	RAM-GDS-SKIN-AP24-A	RAM-GDS-DOCKL-V2-AP24U
iPad Pro 12.9 (5 th Gen)	Non-Locking: RAM-HOL-AP24U Combo Locking: RAM-HOL-AP24CLU Key Locking: RAM-HOL-AP24KLU	RAM-HOL-UN11U	-	-	RAM-GDS-SKIN-AP24-A	-



Mount Anything, Anywhere

2022 Apple Solutions

rammount.com
1.800.497.7479
sales@rammount.com



GDS®, IntelliSkin®, GDS® Tech™, GDS® Technology™, GDS® Green™ and GDS® Compatible™ are trademarks or registered trademarks of National Products Inc. The distinctive D Shape® of the GDS® connector is a trademark of National Products Inc.

PATENTS AND TRADEMARKS
WWW.RAMMOUNT.COM/IP



RAM® double socket arms with their distinctive Hourglass Shape are recognized globally as a symbol of the reliability, quality, and durability of this line of products. The Hourglass Shape is a registered trademark of National Products Inc.



The distinctive RAM® *X-Grip® product shape is a trademark of National Products Inc.



Look for the highly recognizable "Double Delta" trademark, the symbol of quality and reliability